

SPECIFICATIONS

FOR

GALLOPING HILL GOLF CART PATH IMPROVEMENT PROJECT BOROUGH OF KENILWORTH COUNTY OF UNION, NEW JERSEY

BA#59-2015; UNION COUNTY ENGINEERING PROJECT #2015-014

SEPTEMBER 2015

UNION COUNTY OFFICIALS BOARD OF CHOSEN FREEHOLDERS

Mohamed S. Jalloh, Chairman
Bruce H. Bergen, Vice Chairman
Linda Carter, Freeholder
Angel G. Estrada, Freeholder
Sergio Granados, Freeholder
Christophe Hudak, Freeholder
Bette Jane Kowalski, Freeholder
Alexander Mirabella, Freeholder
Vernell Wright, Freeholder

CLERK OF THE BOARD

James E. Pellettiere, RMC

COUNTY MANAGER

Alfred J. Faella

DEPUTY COUNTY MANAGER

Department of Economic Development

William Reyes, Jr., Director

DEPARTMENT OF ENGINEERING, PUBLIC WORKS AND FACILITIES MANAGEMENT

Joseph A. Graziano, Sr., CPWM
Director, Department of Engineering, Public Works and
Facilities Management

COUNTY ENGINEER DIVISION OF ENGINEERING

Thomas O. Mineo, P.E.
2325 South Avenue
Scotch Plains, New Jersey 07076
Telephone: (908) 789-3675
Fax: (908) 789-3674

PREPARED BY:

County of Union Division of Engineering

**COUNTY OF UNION
NOTICE TO BIDDERS**

Sealed bids will be received by the director of the Division of Purchasing, or his designee, at the County of Union, New Jersey on September 30, 2015 at 2:30 p.m., prevailing time, in the 3rd Floor Conference Room, U.C. Administration Building, 10 Elizabethtown Plaza, Elizabeth, New Jersey for:

**GALLOPING HILL GOLF CART PATH IMPROVEMENT PROJECT
BOROUGH OF KENILWORTH, COUNTY OF UNION, NEW JERSEY
BA#59-2015; UNION COUNTY ENGINEERING PROJECT #2015-014**

Bid Packages may be obtained at no charge by registering and downloading at <http://ucnj.org/bid-specs>. Bid Packages may also be obtained in person from the Division of Engineering at 2325 South Avenue, Scotch Plains, New Jersey 07076 between 8:30 a.m. and 4:00 p.m. weekdays upon payment of a non-refundable money order or bank check in the amount of \$275.00 made payable to the County of Union. No Personal / Company checks will be accepted. Requests for mailing of specifications will not be honored. For further information please call 908-789-3675.

The County reserves the right to reject any and all bids and to waive any and all informalities in the bid.

Bids shall be submitted in a sealed envelope and clearly marked with the subject of the bid, name and address of the bidder, phone & fax number, and date of the bid opening. Each bid must be delivered to reach the Division of Purchasing prior to the stated time of the opening of the bids. The County will not be responsible for late delivery by the U.S. Mail or any other carrier. If hand delivered, please note that parking and security access at the County Complex may cause delays and bidders should take them into consideration in order to submit a timely bid. **No** late bids will be accepted.

Bidders are required to comply with the requirements of N.J.S.A. 10:5-31 et seq. and N.J.S.A.C. 17:27.

MICHAEL M. YUSKA – DIRECTOR OF PURCHASING

**UNION COUNTY BOARD
OF CHOSEN FREEHOLDERS**

We're Connected to You!

NB-1

**GALLOPING HILL GOLF CART PATH IMPROVEMENT PROJECT
BOROUGH OF KENILWORTH, COUNTY OF UNION, NEW JERSEY
BA#59-2015; Union County Engineering Project #2015-014**

TABLE OF CONTENTS

Cover Sheet: County Officials
NB-1: Notice to Bidders

GENERAL SPECIFICATIONS

Definitions

Section 1: BID FORM
Section 2: WITHDRAWAL OF BID DUE TO MISTAKE
Section 3: QUALIFICATIONS OF BIDDERS AND REQUIRED SUBMISSIONS
Section 4: INTERPRETATIONS AND ADDENDA
Section 5: OBLIGATION OF BIDDER TO INSPECT SITE AND CONTRACT DOCUMENTS
Section 6: BID AND PERFORMANCE GUARANTEE
Section 7: COMMENCEMENT AND COMPLETION
Section 8: BIDDER AFFIDAVIT
Section 9: BID SECURITY
Section 10: LABOR AND MATERIALS
Section 11: INSURANCE REQUIREMENTS
Section 12: INDEMNIFICATION REQUIREMENTS
Section 13: ROYALTIES AND PATENTS
Section 14: PLANS AND SPECIFICATIONS
Section 15: GUARANTEE AGAINST DEFECTIVE WORK
Section 16: TRAFFIC AND STREET MAINTENANCE
Section 17: CONTRACTOR'S EMPLOYEES
Section 18: OWNERSHIP DISCLOSURES REQUIRED
Section 19: NON-COLLUSION AFFIDAVIT
Section 20: EQUAL EMPLOYMENT OPPORTUNITY COMPLIANCES
Section 21: COMPLIANCE WITH NEW JERSEY PREVAILING WAGE ACT
Section 22: BRAND NAME OR EQUAL
Section 23: LINES AND GRADES
Section 24: NUMBER OF WORKING DAYS
Section 25: PROMPT PAYMENT OF CONSTRUCTION CONTRACTS (NJ Prompt Payment Act)
Section 26: STOPPING WORK ON ACCOUNT OF BAD WEATHER
Section 27: ACCESS FOR OTHER CONTRACTORS
Section 28: CONDEMNED MATERIALS AND WORK
Section 29: STORAGE
Section 30: FINAL CLEAN UP
Section 31: SUB-LETTING OF WORK
Section 32: SAFETY
Section 33: QUALITY, SAFETY AND PERFORMANCE STANDARDS
Section 34: MATTERS NOT MENTIONED IN CONTRACT DOCUMENTS
Section 35: PERMITS
Section 36: CONTRACTOR TO PROVIDE PROOF OF PAYMENT
Section 37: CHANGE ORDERS
Section 38: SUPPLEMENTAL WORK
Section 39: FORM OF CONTRACT
Section 40: PROGRESS PAYMENTS
Section 41: INSPECTION
Section 42: DAMAGES
Section 43: LIQUIDATED DAMAGES
Section 44: AFFIRMATIVE ACTION REQUIREMENTS
Section 45: INVESTMENT ACTIVITIES WITH IRAN

GENERAL SPECIFICATIONS CONTINUED

- Section 46: COMPLIANCE WITH THE PUBLIC WORKS CONTRACTOR REGISTRATION ACT
(N.J.S.A. 34:11-56.48 et seq)
- Section 47: UTILITIES
- Section 48: MATERIAL COMPLIANCE AND SHOP DRAWINGS
- Section 49: PRECONSTRUCTION
- Section 50: DISPUTES UNDER THE CONTRACT
- Section 51: RESOLUTION NO. 2014-0408 ADOPTED ON MAY 8, 2014
BY THE UNION COUNTY BOARD OF CHOSEN FREEHOLDERS
- Section 52: CONTRACTOR BUSINESS REGISTRATION CERTIFICATE
(New Mandatory Requirement – Effective 1/18/2010)
- Section 53: BID PROTEST - LEGAL FEES AND COSTS
- Section 54: AMERICAN GOODS AND PRODUCTS WHERE POSSIBLE
- Section 55: NEW JERSEY PAY-TO-PLAY REQUIREMENTS
- Section 56: STATEMENT OF EQUIPMENT TO BE USED IN CONSTRUCTION
- Section 57: NEW JERSEY SALES AND USE TAX REQUIREMENTS

BIDDING DOCUMENTS

- Bid Document Submission Checklist
- Bidding Documents
- Bid Form
- Consent of Surety
- Bidder Signature Page
- Bidder Disclosure Statement
- Subcontractor Identification Statement: List of Subcontractors
- Subcontractor Identification Certification
- Acknowledgement of Addendum
- Contractor Business Registration Certificate
- Affirmative Action Requirement
- Experience Statement
- Certificate of Bidder Showing Ability to Perform Contract
- Non-Collusion Affidavit
- Contractor Registration Advisement
- Americans with Disabilities Act
- Contractor Responsibility Certification
- Affidavit of General Contractor & Subcontractor OSHA Compliance
- Statement of Bidder's Qualifications
- Contractor Performance Record
- Affidavit Regarding List of Disbarred, Suspended or Disqualified Bidders
- Prior Negative Experience Questionnaire-Certification
- Contractor's Certification of Compliance - New Jersey Prevailing Wage Act
- Uncompleted Contracts Affidavit
- Certificate of Insurance Statement
- Collection of Use Tax on Sales to Local Governments Statement
- Time of Completion
- Disclosure of Investment Activities in Iran

NEW JERSEY PREVAILING WAGE DETERMINATION DOCUMENTS

SS - STANDARD SPECIFICATIONS SS-1

STANDARD FORM OF AGREEMENT BETWEEN OWNER AND CONTRACTOR AIA DOCUMENT A-101/2007
(Draft form until contract is awarded)

GENERAL CONDITIONS OF THE CONTRACT FOR CONSTRUCTION AIA DOCUMENT A-201/2007
(Draft form until contract is awarded)

PROJECT TECHNICAL SPECIFICATIONS

Appendix A - Location Plan

Appendix B – Golf Cart Plan (separate document)

Appendix C – Channel Drain Product Information & Installation Details, 4 pages

Appendix D – Cart Path & Curb Detail

**UNION COUNTY BOARD OF CHOSEN FREEHOLDERS
INSTRUCTIONS TO BIDDERS AND FORMS**

DEFINITIONS

Wherever reference is made to the County, Title of Project, Bidder, or Vendor/Contractor they shall be as follows:

OWNER/COUNTY:

Union County Board of Chosen Freeholders
UC Administration Building, 6th Floor
10 Elizabethtown Plaza
Elizabeth, New Jersey 07207

ADDRESS BIDS AND SUBMIT TO:

Union County Division of Purchasing
UC Administration Building, 3rd Floor
10 Elizabethtown Plaza
Elizabeth, NJ 07207
Attn: Michael Yuska, QPA, Director, Division of Purchasing
Telephone: 908-527-4130
Facsimile: 908-558-2548

**TITLE OF PROJECT: GALLOPING HILL GOLF CART PATH IMPROVEMENT PROJECT
BOROUGH OF KENILWORTH, COUNTY OF UNION, NEW JERSEY
BA#59-2015; UNION COUNTY ENGINEERING PROJECT #2015-014**

BIDDER: Bidder shall be a single overall contract bidder

ENGINEER / ARCHITECT: Division of Engineering, Thomas O. Mineo, P.E.

COUNTY ENGINEER AND/OR CONSTRUCTION MANAGER (as applicable):

COUNTY ENGINEER:

Thomas O. Mineo, P.E.
Union County
Division of Engineering
2325 South Avenue
Scotch Plains, NJ 07076
Office: (908) 789-3675
Facsimile: (908) 789-3674
Email: tmineo@ucnj.org

CONSTRUCTION MANAGER:

GENERAL SPECIFICATIONS

1. BID FORM

Bids for this Work will be enclosed in a sealed envelope addressed to the Purchasing Division, County of Union, New Jersey, Union County Administration Building, 10 Elizabethtown Plaza, Elizabeth, New Jersey 07207, with the full name of the Project clearly marked on the outside. Refer to the sheet marked "Notice of Bid (Advertisement)" for the correct name of the Project. Bidders must submit their bids on the attached pricing sheet (Bid Form), in a sealed envelope addressed to the County and bearing on the outside: the name of the Bidder, Bidder's business address, and the title of the Project.

The Division of Purchasing will receive the bids for this Work at the Union County Administration Building, 10 Elizabethtown Plaza, Elizabeth, New Jersey on the date and time noted on the sheet marked "**Notice of Bid (Advertisement)**".

The County will not assume responsibility for bids forwarded by mail. It is the individual's responsibility to see that the bids are presented to the Purchasing Division at the time and at the place designated.

Bids will be accepted only on the Bid Form supplied. Bids on forms other than the original supplied herein will be rejected. The "complete" Bid Documents includes the Bid Bond, Bid Form, Bidder's Checklist, Consent of Surety, Ownership Disclosure Certification, Non-Collusion Affidavit, and any other documents noted in these Instructions to Bidders or Contract Document to be submitted with this Bid. (See AIA Owner/Contractor Agreement & General Conditions attached.)

The bidder will state in the bidding sheet the price per unit of measure for each scheduled Item of Work for which he will agree to carry out the Work, and the Total Bid Price for the construction of the Project.

The prices in the Bid Form shall be typed or written in pen and ink. Erasures or alterations must be initialed by the bidder in ink.

The bidding sheet for this Project may include a fixed amount as a Bid Allowance. If applicable, all bidders are required to add this fixed amount to their base bid and to include this additional amount in their Bid Bond. This sum will be included in the Contract as well as the performance, labor and materials bond. Payment by the County will be made to the Contractor from these funds only upon the completion of extra Work pursuant to a written Change Order(s) signed by the County's Engineer or his designee and the Contractor, prior to the commencement of such Work. Work commenced prior to written approval by the County shall be done at Contractor's risk. Such payment will only be in the amount agreed to by the parties, in writing in the Change Order(s). See Section 37, Change Orders, of these general specifications for further details.

Refer to Bid Document Submission Checklist for all required documents.

In the event there is a discrepancy between the unit price given and the extended total, the unit price will govern. Any discrepancies will be mathematically adjusted.

Insert applicable alternates, if any have been specified, applicable to the Bidder's Work. All alternates MUST be bid upon. Any Bidder's failure to do so will be deemed a material, non-waivable defect and shall render the bid nonresponsive. The Bidder shall clearly designate whether the change in price is an addition or subtraction, by using either a "+" sign or the word "addition", or in the alternative, a "-" sign or the word "minus". If there is no other change in price, the Bidder shall insert "NC" or "No Charge".

When two or more low bids are equal in all respects, awards will be made according to the provisions of N.J.S.A. 40A:11-6.1(d).

Where unit prices have already been established by the Contract Documents, the Bidder agrees that such unit prices shall prevail. All unit prices, whether filled in by the Bidder or established by the Contract Documents, shall become part of the Contract. No bid will be considered or award made, unless applicable unit prices, as required, are filled in.

The County reserves the right to reject any or all bids and also reserves the right to waive any informality in the bids received so long as said waiver is not of a response which is considered to be material and non-waivable pursuant to law.

The County of Union has the right to reject any and all bids from any bidder that is in, or contemplates bankruptcy of any chapter of nature. Said bidder shall notify the County, in writing, of any condition or knowledge of the same.

Conditional bids will not be accepted. Bids may be withdrawn prior to the advertised time for the opening of bids or authorized postponement thereof or in accordance with the provisions of N.J.S.A. 40A:11-23.3 discussed below. Bids received after the advertised time shall not be considered. Bidders shall be solely responsible for premature opening or late delivery of bids not properly marked, addressed, or directed.

2. WITHDRAWAL OF BID DUE TO MISTAKE

N.J.S.A. 40A:11-23.3 authorizes a bidder to request withdrawal of a public works bid due to a mistake on the part of the bidder. A mistake is defined by N.J.S.A. 40A:11-2(42) as a clerical error that is an **unintentional and substantial computational error or an unintentional omission of a substantial quantity of labor, material, or both, from the final bid computation.**

A bidder claiming a mistake under N.J.S.A. 40A:11-23.3 must submit a request for withdrawal, **in writing**, by certified or registered mail to Michael M. Yuska, QPA, Director, Division of Purchasing, County of Union, New Jersey, Union County Administration Building, 10 Elizabethtown Plaza, Elizabeth, New Jersey 07207. The bidder must request withdrawal of a bid due to a mistake, as defined by the law, within five business days after the receipt and opening of the bids. Since the bid withdrawal request shall be effective as of the postmark of the certified or registered mailing, Michael M. Yuska, QPA, Director of the Division of Purchasing or his designee may contact all bidders, after bids are opened, to ascertain if any bidders wish to, or already have exercised a request to withdraw their bid pursuant to N.J.S.A. 40A:11-23.3.

A bidder's request to withdraw the bid **shall** contain evidence, including any pertinent documents, demonstrating that a mistake was made. Such documents and relevant written information shall be reviewed and evaluated by the County's designated staff pursuant to the statutory criteria of N.J.S.A. 40A:11-23.3.

The County will not consider any written request for a bid withdrawal for a mistake, as defined by N.J.S.A. 40A:11-2(42), by a bidder in the preparation of a bid proposal unless the postmark of the certified or registered mailing is within the five business days following the opening of bids.

3. QUALIFICATIONS OF BIDDERS AND REQUIRED SUBMISSIONS

The County may make such investigation as it deems necessary to determine the ability of the Bidders to perform the Work, which includes investigation of any and all subcontractors listed with the bid. The Bidder shall furnish any information and data for this purpose as the County may request.

4. INTERPRETATIONS AND ADDENDA

Any explanation desired by a bidder regarding the meaning or interpretation of the Contract Documents must be requested in writing to the County Engineer or Design Professional as the case may be and with reasonable time allowed for a reply to reach bidders before submission of their bids. Any interpretation or instruction made by the County Engineer will be in the form of an addendum to the Contract Documents or clarification and will be furnished to all prospective bidders. Oral explanations or instructions given before the award of the Contract will not be binding. Bidders are required to bring to the attention of the County Engineer, the discovery of any apparent ambiguity, inconsistency, error, discrepancy, omission in the Contract Documents for interpretation and correction at least ten (10) working days before opening of bids with the exception of Saturdays, Sundays and holidays.

All Addenda issued through the Offices of the County Engineer are amendments to the Contract Documents and shall be considered in preparing bids. Same shall become part of the Contract Documents.

Addenda take precedence over all earlier documents and over each other according to the latest date. Addenda unless themselves interpretive remain subject to interpretation the same as any other document incorporated in the Contract.

Addenda may be issued by the County Engineer up to seven (7) working days prior to the opening of bids. Failure of any bidder to receive an addendum shall not relieve such bidder from the obligation imposed by such addendum. Bidders are to keep themselves currently acquainted with the Contract Documents during the entire bidding period and make inquiry on their own initiative as to issuance of any Addenda. Receipts of all Addenda shall be acknowledged on the "*Acknowledgement of Receipt of Changes*" included in the bid package and must be submitted with the bid.

5. OBLIGATION OF BIDDER TO INSPECT SITE AND CONTRACT DOCUMENTS

At the time of the opening of bids, each Bidder will be presumed to have inspected the site(s) and to have read, and be thoroughly familiar with the Contract Documents. The failure or neglect of any Bidder to receive or examine any form, instrument, or document shall in no way relieve any Bidder from any obligation in respect to its bid.

The Bidder shall examine the contents of the Project Manual and the set of Drawings and assure itself that all pages of the Specifications, Drawings, and other Contract Documents are included in the documents obtained for bidding purposes. Should the Specifications, Drawings, and other Contract Documents be incomplete, the Bidder shall notify the County Engineer in writing, who will supply the Bidder with any missing pages of Specifications, Drawings, or other Contract Documents. The lack of such written notification by the Bidder will be construed as evidence that the Specifications, Drawings, or other Contract Documents supplied it for bidding purposes are full and complete and as a waiver of any subsequent claim to the contrary.

6. BID AND PERFORMANCE GUARANTEE

Each bidder must furnish a Bid Bond, Certified Check or Bank Cashier's Check in the amount of ten percent (10%) of the Bid. Checks shall be drawn to the order of the County of Union, New Jersey, not to exceed \$20,000.

Each bidder must furnish with the bid a certificate from a Surety Company, i.e. Consent of Surety, stating that in the event of the contract being awarded to said bidder, such Surety Company will provide the Contractor with Bonds guaranteeing the faithful performance of the Work in accordance with the plans and specifications, and the payment for labor, materials, and all other indebtedness which may accrue on the account of this Work. A Performance, Labor and Materials bond will be furnished by the Contractor upon an award of Contract, and will be in the amount of 100% of the contract price.

A one-year Maintenance Bond will be required upon acceptance of the Project by the County in the amount as stated in Section 15 of the General Specifications. Bonds will be written by a firm authorized to issue the bonds under the laws of the State of New Jersey and be in a form acceptable to the County Counsel.

N.J.S.A. 40A:11-1.1 et. seq. allows the prime Contractor to furnish the Performance Security for his Subcontractors. The County of Union requires Performance Security to be furnished by the prime contractor for the entire job in the total amount of the contract.

The County of Union shall award the contract or reject all bids within sixty (60) days; except that the bids of any bidders who consent thereto may, at the request of the County be held for consideration for such longer periods as may be agreed.

The County will return all certified checks or cashier's checks after the proposals have been opened, read, tabulated and checked except those of the three (3) bidders who have bid the lowest total price for carrying out the Project. The County will return the checks of these bidders when a contract is awarded to the successful bidder within ten (10) days after the award of the contract.

If the successful bidder refuses or neglects to sign the said Agreement and furnish the required bonds, the Bid Bond will be held and used by the County to offset any damages for such refusal or neglect.

7. COMMENCEMENT AND COMPLETION

Work will not commence until a Notice to Proceed is received from the County Engineer.

Upon substantial completion of the Project, the Contractor must request a joint inspection with the County Engineer. Upon completion of this inspection, the County Engineer will prepare a list of incomplete or incorrect items (punch list) and have Contractor initial and date same. The Contractor shall rectify all deficiencies noted on the punch list within 30 calendar days of receipt of the list. The County Engineer may approve extensions for extenuating circumstances.

8. BIDDER AFFIDAVIT

All Bidders are required to complete, sign, and submit with their Bid, the attached "Affidavit Regarding List of Debarred, Suspended or Disqualified Bidders". (See form enclosed)

9. BID SECURITY

All Bidders are required to submit a form of Bid Security with their bids.
(Bid Bond or Certified Funds)

The Bid Security shall be in the amount of ten percent (10%) of the Bid, but not in excess of Twenty Thousand Dollars (\$20,000.00), and payable to the order of the "County of Union."

10. LABOR AND MATERIALS

The prices will cover all costs of any nature incident to and growing out of the Work, including all labor, material, equipment, transportation, loss by damage or destruction of the Project, settlement of damages, and for replacement of defective work or materials. N.J.S.A. 54:32B-1 et seq. exempts all materials sold to the County of Union from sales or use taxes and should not be included in the prices provided on the Bidding Sheet.

11. INSURANCE REQUIREMENTS

The County of Union requires all contractors to be able to comply with the following insurance requirements. In the event a bid is accepted by the County, the contractor must accept the applicable insurance requirements, as set forth below, as part of any contract awarded to it by the County.

Contractor shall carry and maintain at all times while the contract is in full force and effect, the following insurance coverage with an insurance company or companies acceptable to the County, with limits not less than those shown below. A Certificate of Insurance shall be filed with the County prior to commencement of any Work indicating the following:

- a) Commercial General Liability (CGL): Coverage for all operations including, but not limited to, contractual, products and completed operations, and personal injury with limits no less than \$5,000,000 per occurrence/\$10,000,000 aggregate. The County of Union, its Board of Chosen Freeholders, officers, employees, agents and servants shall be included as an additional insured. Coverage is provided on a primary and non-contributory basis to the County of Union, et al.
- b) Automobile Liability: Coverage for all owned, non-owned and hired vehicles with limits not less than \$5,000,000 per occurrence, combined single limits (CSL) or its equivalent.
- c) Workers Compensation: As required by the State of New Jersey and Employers Liability with limits not less than \$1,000,000 per accident for bodily injury or disease.
- d) Professional Liability (if design/build): Coverage with limits not less than \$1,000,000 per occurrence or claim, \$2,000,000 aggregate

- e) Contractor's Pollution Legal Liability and/or Asbestos Legal Liability and/or Errors & Omissions (if project involves environmental hazards): Coverage with limits no less than \$1,000,000 per occurrence or claim/\$2,000,000 aggregate.
- f) Builders Risk (for major renovations): During the course of construction utilizing an "All Risk" coverage form with limits equal to the completed value of the project and no coinsurance penalty provisions.

Where applicable, a waiver of subrogation in favor of the County of Union, its Board of Chosen Freeholders, officers, employees, agents, servants and the State of New Jersey is to be included in those policies of insurance where permitted by law.

Notice of Cancellation: Each insurance policy required above shall provide that coverage shall not be canceled, except with notice to the Entity.

Special Risks or Circumstances: The County reserves the right to modify these requirements, including limits, based on the nature of the risk, prior experience, insurer, coverage, or other special circumstances.

12. INDEMNIFICATION REQUIREMENTS

The County of Union requires all bidders to accept the following indemnification requirements in the event the County accepts their bid. The Contract awarded by the County to the successful bidder will contain the following provision:

"To the fullest extent permitted by law the Contractor shall indemnify and hold harmless the owner and the owner's consultants, agents, representatives, and employees from and against any and all claims, damages, losses, costs, and expenses, including, but not limited to attorneys' fees, legal costs and legal expenses arising out of or resulting from the performance of the Contractor's work under this contract, provided that such claim, damage, loss, cost, or expense is attributable to bodily injury, sickness, disease or death, or to injury to or destruction of tangible property (other than the work itself) caused or alleged to be caused by the negligent acts, negligent omissions, and/or fault of the Contractor, anyone directly or indirectly employed or retained by the Contractor, or anyone for whose acts the Contractor may be liable regardless of whether caused in part by the negligent act or omission of a party indemnified hereunder provided it is not caused by the sole negligence of a party indemnified hereunder. Contractor shall further indemnify and hold harmless the County and the County's consultants, agents, representative, and employees from and against any and all claims, damages, losses, costs, and expenses, including, but not limited to attorneys' fees, legal costs and legal expenses, arising out of or resulting from performance of the work, provided that such claim, damage, loss, cost, or expense is attributable to bodily injury, sickness, disease or death, or to injury to or destruction of tangible property (other than the work itself) caused or alleged to be caused by the negligent acts, negligent omissions, and/or fault of

the County or the County's consultants, agents, representatives, or employees and arises out of this project and provided such claim, damage, loss, cost, or expense is not caused by the sole negligence of a party indemnified hereunder."

13. ROYALTIES AND PATENTS

The Contractor shall pay all royalties and license fees. He shall defend all suits or claims for infringement of any patent rights and shall hold the County harmless from loss on account thereof.

14. PLANS AND SPECIFICATIONS

In carrying out the Work, the plan(s) and the specifications will be followed by the Contractor. Minor alterations in the plan may be made or permitted by the County Engineer from time to time and, if no additional Work is necessary, there will be no additional charge for carrying out such minor alterations.

The Contractor shall provide the County Engineer a set of reproducible as-built drawings upon completion of the Project. The Contractor shall maintain an updated construction progress plan in the Project field office at all times.

When applicable, The New Jersey Department of Transportation Standard Specifications for Road and Bridge Construction, as amended, and Supplemental Specifications for State Aid Projects, herein after referred to as the "Standard Specifications", are made a part of these specifications and contract for the improvements, and will govern the construction of this Project, the material used and the execution of this Project, except as revised and modified herein. The references to these specifications are given herein for the purpose of aiding in the rapid location of the description of the various items herein specified. The entire Work must be carried on and completed to the satisfaction of the County. The Standard Specifications are amended as follows:

"Any reference to the Commissioner, Department, Department Laboratory, Engineer or Inspector should be redefined to be the County of Union".

15. GUARANTEE AGAINST DEFECTIVE WORK

Prior to final payment being made or before the release of the performance security required by Section 3 above, the Contractor and Surety shall execute and deliver to the County an original Maintenance Bond with an original signature and seal having a penal sum equal to:

- A) One hundred percent (100%) of the final adjusted Contract amount, if such amount is \$50,000.00 or less;

- B) Fifty percent (50%) of the final adjusted Contract amount, if such amount be greater than \$50,000.00 but less than \$250,000.00; and,
- C) Twenty-five percent (25%) of the final adjusted contract amount, if such amount is \$250,000.00 or more.

The Bond and Surety shall be satisfactory to the Union County Counsel. The Surety shall hold a Certificate of Authorization to do business in the State of New Jersey and shall conform to P.L. 1995 c.384, codified as N.J.S.A. 2A:44-143, 144. The Surety Disclosure Statement and Certification required by N.J.S.A. 2A: 44-143, 144, shall be attached to the Bond. Such Maintenance Bond shall remain in full force and effect for a period of one (1) year from the date of Final Completion. Such Maintenance Bond shall also provide that the Contractor and the Surety guarantee to replace for the said period of one (1) year from the date of Final Completion, all Work performed and/or all materials furnished that were not performed or were not furnished in accordance to the terms and performance requirements of the Contract Documents, and will make good any defects thereof which become apparent before the expiration of one (1) year. If, during that period, any part of the Project, in the judgment of the Engineer, is found defective, the Contractor will repair or replace same within five (5) days of receipt of notice from the County Engineer. If the Contractor refuses or neglects to do such Work in the time specified, the County Engineer may have the Work done by others and the Contractor or his Surety thereof will pay the cost.

The Contractor will furnish the County a Maintenance Bond for a percentage of the final adjusted contract price, as stated above. The one (1) year period will start the day of Final Completion of Project by the County. Final payment is conditional on the receipt of a maintenance bond in a form acceptable to County Counsel.

16. TRAFFIC AND STREET MAINTENANCE

The Work must be started and performed by the Contractor in such a manner as to minimize delays to the traveling public. It must be completed in a timely fashion, with little or no inconvenience to traffic and pedestrians, where such inconvenience may be avoided.

All municipal, county, and state roadways shall remain open to traffic unless otherwise provided for in the technical specifications.

If modified traffic patterns are authorized in order to provide a safe working or traveling environment, the Contractor is responsible for providing all equipment, barrels, cones, signs, and barricades to implement the work zone and detours, unless otherwise specified in the technical specifications. All work zones and detours shall be established in accordance with the technical plans and specifications if provided or in strict compliance with the current version of the Manual for Uniform Traffic Control Devices (MUTCD). The Contractor shall obtain approval for these work zones and

detour plans from the Municipal Police or applicable police agency and the Union County Bureau of Traffic Maintenance prior to implementation.

All traffic control plans shall provide for safe movement of vehicular, bicycle, and pedestrian traffic. Particular attention shall be given to requirements of the Americans with Disabilities Act.

No portion of any street or alleyway may be used for the storage of any materials or equipment without the approval of the Municipal Police or other applicable police agency. Sidewalks, gutters, drains, fire hydrants and private drives shall be maintained for their intended use unless specifically approved by the County Engineer.

Upon suspension of Work, at the end of the day or for protracted periods, the Contractor shall remove all rubbish and materials from the Work site to the approved storage/staging location. All road cuts, saw cuts, and trenches that may pose hazard to vehicular, pedestrian, or bicycle traffic, to include handicapped users, shall be filled to the surface of the roadway or sidewalk. At no time will steel plates or settled trenches be allowed at the daily suspension of Work, unless specifically approved by the County Engineer.

Use of Traffic Control Officers shall be determined by the County in accordance with the provisions of N.J.S.A. 40A:11-23.1(c). If applicable to the Project, the County shall have provided an allowance for same as set forth in the Bid Form.

With respect to pedestrian traffic, the Contractor shall install signs restricting access of the general public and, as necessary, Union County employees to the area of construction. The Contractor shall provide safe access to required areas and place physical barriers to restricted areas. These barriers may range from caution tape to actual barriers, at the direction of the County Engineer.

17. CONTRACTOR'S EMPLOYEES

The Contractor must employ only suitable and competent labor in the Work, and must remove from the Work any incompetent, unsuitable, or disorderly person upon complaint from the County Engineer.

The parties to any contract resulting from this proposal do hereby agree that the provisions of N.J.S.A. 10:2-1 through 10:2-4 (discrimination in employment on public works contracts): 34:11-56.25 et seq. (payment of prevailing rate of wages determined pursuant to N.J.S.A. 34:11-56.30 by the Commissioner), and the Rules and Regulations promulgated pursuant thereto, are hereby made a part of any contract and are binding upon them.

There will be no discrimination against any employee who is employed in the Work to be covered by any contract resulting from this bid because of age, race, creed, color, national origin, ancestry, marital status or sex.

Any person, firm, or corporation violating the provisions of this Section will be deemed and judged a disorderly person.

18. OWNERSHIP DISCLOSURES REQUIRED

Pursuant to P.L. 1977, N.J.S.A. 52:25-24.2, the Bidder shall submit with its Bid, or prior to receipt of bids, a statement setting forth the names and addresses of all stockholders in the corporation or partnership bidding who own ten percent (10%) or greater interest therein. (See forms attached)

19. NON-COLLUSION AFFIDAVIT

The Bidder shall submit with its bid either the attached completed "Non-Collusion Affidavit" or a statement of non-collusion with verbiage similar to same.

20. EQUAL EMPLOYMENT OPPORTUNITY COMPLIANCES

The successful bidder shall be required to complete and submit an Initial Project Workforce Report, New Jersey Department of Treasury Form AA-201, upon notification of award. Failure to submit this completed form may result in the Contract being terminated.

The successful bidder shall also be required to submit a copy of its Monthly Project Workforce Report, New Jersey Department of Treasury Form AA-202, to the New Jersey Department of Treasury's Division of Public Contracts Equal Employment Opportunity Compliance and to the Board.

21. COMPLIANCE WITH NEW JERSEY PREVAILING WAGE ACT

The County of Union, in order to fulfill the requirements of N.J.S.A. 34:11-56a.25 et seq, requires that the following additional conditions be strictly followed. The bidders represent that he is not listed or is not on record in the Office of the Commissioner or the Department of Labor and Industry as one who failed to pay prevailing wages in accordance with the provisions of this Act. The bidder agrees to the inclusion of a contract provision upon award which specifically requires said Contractor to fully comply with each and all of the requirements of the aforesaid Act as it relates to prevailing rates of wages on public contracts as set forth in the New Jersey Prevailing Wage Act, P.L. 1963, Chapter 150 and P.L. 1974, Chapter 64.

A Copy of the Prevailing Wage Rates is attached for your reference. Applicable rates are those wages and fringe benefit rates in effect on the date the contract is awarded. All predetermined rate increases listed at the time the contract award must also be paid, beginning on the dates specified. Rates may change between the time of issuance of this determination and the award of the public works contract. Therefore, prior to the award of the contract, verification must be made with the Public Contracts section, to insure that the rates contained in this determination are still prevailing.

The Contractor agrees to abide and be bound by each and all of the said statutory provisions with respect to the payment of prevailing rates of wages, and acknowledges that the County reserves the right to terminate the Contractor's (or his subcontractors') right to proceed with the scope of Work, or such portion thereof that relates to the failure to pay prevailing rates of wages. In such event or under the terms of N.J.S.A. 34:11-56.27, the Contractor and his surety will be liable to the County of Union for any excess costs occasioned by such a violation.

The Contractor or subcontractors for this Project will post the Prevailing Wage Rates for each craft and classification involved as determined by the Commissioner of Labor and Industry, including the effective date of any changes thereof, in prominent and easily accessible places at the site of the Work or at such place or places as are used by them to pay workmen their wages.

The County of Union requires a copy of payroll records from the Contractor and subcontractors. Payroll records shall be submitted with each voucher request for payment. Prevailing wage rates may be obtained from the New Jersey Labor, Division of Workplace Standards, Public Contracts Section, (609-292-2259).

In addition to compliance with the New Jersey Prevailing Wage Act, the County requires compliance with procedures established by Resolution No. 2014-0408 adopted by the Union County Board of Chosen Freeholders on May 8, 2014. The resolution is furnished in Section 51 of these General Specifications.

UNION LABOR IS PREFERRED ON ALL COUNTY WORK

The foregoing reference to specific laws will not be deemed to be a limitation of obligation of the Contractor to perform his obligations in full compliance with the provisions and requirements of all federal and state statues and local ordinances applicable to the Work to be done under the contract.

It is agreed and understood that any contracts and/or orders placed as a result of this proposal will be governed and construed and the rights and obligations of the parties hereto will be determined in accordance with the laws of the State of New Jersey.

Upon completion of the Work, the Contractor will furnish a Certification of Compliance with the New Jersey Prevailing Wage Act. The certificate in a form acceptable to County Counsel is a condition of the final payment. (See form attached)

22. BRAND NAME OR EQUAL

When the Specifications, Forms, and other Contract Documents use “brand name or equivalent” or similar language, the listed brand name shall serve as a reference or point of comparison for the functional or operational characteristic desired for the goods or services being requested. Where a bidder attempts to submit an equivalent product for a brand name, it shall be the responsibility of the bidder to fully describe and document the product to be provided with the bid in order to establish the equivalence claim.

- A. If the Bidder proposes to offer substitute goods as an equal to those specified herein, the bidder shall so indicate with the Bid Proposal. For the purposes of this paragraph, a proposed item shall be considered equal to goods specified herein if:
 - 1. The County, in its sole discretion, determines that: (i) the goods conform substantially, even with deviations, to the brand name goods specified herein; (ii) the goods are equal to or greater than the brand name goods specified herein in terms of quality, durability, functionality, appearance, strength and design; (iii) the goods are capable, at least as well as the brand name goods specified herein, or performing with existing equipment; and (iv) the goods do not cost the County more than the brand name goods specified herein costs the County.

- B. To offer substitute goods as an equal to those specified herein, it is necessary that:
 - 1. The Bidder submits sufficient information with its bid to permit the County to determine that the goods are equivalent to the brand name goods specified herein, including, but not necessarily limited to the brand, catalog number and specifications/data sheets;
 - 2. The Bidder fully identifies and describes the variations of the goods from the brand name goods specified herein on a separate sheet that is to be submitted with the bid proposal. Bidder’s literature WILL NOT suffice in explaining exceptions to these specifications.

3. The Bidder certifies that the goods (i) are similar in substance to the brand name goods specified, and (ii) are suited to the same use as the item specified;
- C. The County shall be allowed a reasonable time within which to evaluate the Bidder's proposal to offer substitute goods as an equal to those specified herein. The County shall be the sole judge of acceptability. No "or-equal" goods shall be ordered, delivered, assembled, set-up or utilized until the County's evaluation is complete. The County's determination as to equivalency shall be deemed final and absolute.

In the event the Bidder does not provide sufficient supporting documentation with the bid, it will be presumed and required that the brand name goods and services as described in the specifications will be provided.

23. LINES AND GRADES

Normally, horizontal and vertical control points will be provided in the technical specifications. All other surveying will be the responsibility of the Contractor unless otherwise noted.

24. NUMBER OF WORKING DAYS

In accordance with NJSA 40A:11-17, the Work for the within Project shall be completed as specified on the Time of Completion Form. See form attached

There shall be taken a deduction from the contract price, or any wages paid by the County, to any inspector(s) necessarily employed by it on the Work, for any number of days in excess of the number allowed in the specifications.

25. PROMPT PAYMENT OF CONSTRUCTION CONTRACTS (NJ Prompt Payment Act)

Pursuant to NJSA 2A:30A-1 et. seq., payment to the Contractor, other than for Work done pursuant to a contract allowance, where applicable, shall be processed and paid as follows:

1. All contractor bills shall be either approved for payment, or notice provided as to why the bill or any portion of it will not be approved by the representative(s) of the governing body no later than the public meeting following 20 calendar days of the billing date as defined in the statute.

2. If the billing is approved, said bill shall be paid in the payment cycle following the meeting.

26. STOPPING WORK ON ACCOUNT OF BAD WEATHER

Work must only be performed in weather suitable for the type of construction planned or underway. Extremes in temperature, humidity, precipitation, evaporation, etc. can detrimentally affect the constructed product. Refer to the Standard and Technical Specifications for specific items.

27. ACCESS FOR OTHER CONTRACTORS

The Contractor for this Work will give proper access to other contractors who may be employed upon the Project and must not hinder or delay unnecessarily any Work that may be progressing under other contracts.

28. CONDEMNED MATERIALS AND WORK

Any materials and or part of the Work that may be condemned by the County Engineer will be removed and replaced by the Contractor or otherwise rectified, as may be directed by the County Engineer. No payment will be made upon the Work until such faulty work has been made good as may be directed. In the event the Contractor refuses or neglects to make good such faulty work, he will be deemed to have abandoned the contract and proceedings may be taken against him as provided herein.

29. STORAGE

In the event that it is necessary for the Contractor to stockpile or store materials or equipment on the job site, the Contractor shall inform the County of such necessity and the County may offer available space, if any, for storage of such materials or equipment. The Contractor shall use said space only for such purpose. Any and all materials which may be stored in such space or which may be brought onto the job site at any time by the Contractor will be at the Contractor's sole risk. The County will not be responsible for loss of or damage to said materials or equipment for any cause whatsoever. The Contractor shall take necessary measures to protect any such storage area and shall be responsible for any and all damages.

30. FINAL CLEAN UP

Upon completion of the Work, the Contractor will remove all equipment, unused materials, rubbish, etc., and will repair, or replace in an a manner acceptable to the County Engineer, all areas that may have been damaged in the prosecution of the Work. Same shall be a condition precedent to final payment. Should said Contractor

fail to comply with this requirement, the County shall undertake the clean-up with its own forces and charge the cost of same against the Contractor's contract balance.

31. SUB-LETTING OF WORK

Except for the List of Subcontractors, pursuant to NJSA 40A:11-16 (See form attached), no portion of the Work will be sublet by the Contractor to any other entities, except with the consent of the County Engineer. A complete list of subcontractors must be submitted to the County Engineer at the preconstruction meeting. If the job does not warrant a preconstruction meeting, the Contractor must submit such list prior to the start of Work.

All Subcontractors will be subject to NJSA 34:11-56 et al.

N.J.S.A. 40A:11-16 requires the bidder to list in the bid sheets the name or names of all subcontractors involved in the following types of Work: plumbing and gas fitting and all kindred work, steam and hot water heating, ventilating apparatus, steam power plants and kindred work, electrical work, ornamental iron work, and structural steel. In addition, the County may require the identification of specific additional subcontractors. If these trades are expected to be part of the contract, such subcontractors should be listed on the "Subcontractor Identification Statement List of Subcontractors" and Bidder shall certify same on the accompanying sheet titled "Subcontractor Identification Certification". (See forms attached) **Bidder's failure to submit these two forms shall be considered a material defect and result in rejection of Bidder's bid.** Substitutions of any listed subcontractors pursuant to NJSA 40A:11-16 will not be permitted except with the consent of the County Engineer.

32. SAFETY

The Contractor shall observe all rules and regulations of the Federal, State, and local health officials. Attention is directed to Federal, State, and local laws, rules, and regulations concerning construction safety and health standards. The Contractor shall not require any worker to work in surroundings or under conditions that are unsanitary, hazardous, or dangerous to the worker's health or safety.

The Contractor shall admit to the site, without delay and without the presentation of an inspection warrant, any inspector of OSHA or other legally responsible agency involved in safety and health administration upon presentation of proper credentials.

The Contractor shall make available to the Contractor's employees, subcontractors, the County Engineer, and the public, all information pursuant to OSHA 29 CFR Part 1926.59 of The Hazard Communication Standard 29 CFR 1910.1200, and shall also maintain a file on each job site containing all Material Safety Data Sheets (MSDS) for products in use at the Project. These Material Safety Data Sheets shall be made available to the Engineer upon request.

The Contractor shall at all times conduct the Work to provide for the safety and convenience of the general public and protection of persons and property. The safety provisions of applicable laws, OSHA regulations, building and construction codes, and the rules and regulations of the New Jersey Department of Labor and Commerce shall be observed.

33. QUALITY, SAFETY AND PERFORMANCE STANDARDS

All goods and services must be constructed and provided with the highest quality materials and workmanship. It is the intent of these specifications that only equipment equal to, or exceeding, the standard specified will be acceptable in order to protect the safety of the occupants of the Building.

34. MATTERS NOT MENTIONED IN CONTRACT DOCUMENTS

Any Work, material, or method, not specifically described in these specifications, but shown upon the plans of the Work, will be carried out as shown on said plan.

35. PERMITS

The Contractor will obtain all necessary permits required by law and provide the County with necessary approvals prior to commencement of permitted Work.

36. CONTRACTOR TO PROVIDE PROOF OF PAYMENT

Upon the completion of the Work, the Contractor will furnish a General Release as proof that all claims for labor, materials, etc., have been settled by the Contractor. The General Release, in a form acceptable to County Counsel, is a condition of final payment.

37. CHANGE ORDERS

Change Order Procedures shall comply with *N.J.A.C. 5:30-11.1 et seq.*, "Change Orders and Open End Contracts" and subsequent provisions of the New Jersey Administrative Code.

38. SUPPLEMENTAL WORK

In case any supplemental work is necessary, it will be performed by the Contractor at a price fixed by agreement between the Contractor and the County Engineer and approved by the County as specified in Section 36. The Contractor will do no supplemental work on any character, for which the Contractor will demand pay, except upon the written order of the County.

39. FORM OF CONTRACT

Contracts will be let on the attached Form of Agreement Between County (“Owner”) and Contractor (AIA 101), and General Conditions (AIA 201), as supplemented.

The Contract will be subject to all statutory provisions on the matter of Public Works, Public Contracts, The Law Against Discrimination, the Laws Governing Affirmative Action and Prevailing Rates of Wages under the laws of New Jersey.

The Agreements shall be executed by both parties not later than twenty-one (21) days from the date of the award by the County (Sundays and holidays excluded); however, such time frame may be extended by agreement of the parties.

40. PROGRESS PAYMENTS

Monthly progress payments will be made based on the value of labor and materials incorporated in the Work and of materials suitably stored at the site. An itemized schedule of values shall be submitted with each Application for Payment.

(Refer to the Owner/Contractor Agreement for Retainage and other conditions pertaining to payment and the application of NJSA 2A:30A-1 et. seq.)

All Applications for Payment shall be accompanied by paid invoices for materials incorporated in the Work and for materials suitably stored at the site, and affidavit(s) by Subcontractors whose Work was included in the next to the last application to the effect such Work and such materials have been paid for.

No payment shall be made without Contractor having provided all submittals set forth in this Section, and the approval of same by the County.

For contracts exceeding \$100,000.00, monthly payments will be made on the Work to the extent of 98% of the value of the Work done which is considered to be retainage.

For contracts less than \$100,000.00, monthly payments will be on the Work to the extent of 90% of the value of the Work done. In lieu of the retainage, the Contractor will, at his option, deposit with the County Counsel negotiable bearer bonds of the State of New Jersey or any political subdivision thereof, equal to the amount otherwise withheld as retainage.

When the Project is completed, the final cost of the Project will be based on actual quantities of authorized Work done under each item scheduled in the bidding sheet and approved Change Orders, if any. The money due to the Contractor as

determined by said final certificate after deduction of previous monthly payments on account, will be paid to the Contractor in accordance with the terms of the contract dealing with Prompt Payment, providing, however that before such final payment is made, all outstanding claims against the Contractor must be satisfied. Before final payment is released, the Contractor must furnish: **a)** Maintenance Bond (see Section 6 of these general specifications); **b)** Certification of Compliance, New Jersey Prevailing Wage Act (see Sections 21 and 51); and **c)** General Release (see Section 36) in a form satisfactory to County Counsel; **d)** complete set of as-built plans in the latest AutoCad on compact disc; and **e)** a complete set of in-progress photos in jpg, jpeg, or bmp digital format on a compact disc.

41. INSPECTION

The Work must be done in accordance with the plans and specifications, and will be inspected by the County Engineer. An inspector may be placed upon the Work at any time by the County Engineer to see that the plans, specifications, and instructions of the County Engineer are carried out. In connection herewith, bidders are referred to N.J.S.A. 40A:11-17.

42. DAMAGES

The Contractor will be held responsible for all damages that may occur to Work, or to persons or property by reason of the nature of the Work or from the elements, or by reason of inadequate protection of the Work, or from any carelessness or negligence on his part or on the part of his employees. The County will withhold payments on the Work until all suits or claims for damages sustained on, or by reason of, this Work will have been settled by the Contractor.

The construction and final completion of this Work will be guaranteed by the Contractor. Any damages that may be done to the Work or any part thereof, by the elements or otherwise, during its construction, will be made good by the Contractor.

43. LIQUIDATED DAMAGES

If the Project is not completed within the time specified herein or within such further time as may have been granted by the County Engineer, then the Contractor hereby agrees to pay to the County as liquidated damages, but not as a penalty, \$1,000.00 per day for each and every calendar day that he is in default on time to complete the Work. The said sum will be deducted from moneys due the Contractor and if the damages exceed this amount, then the Contractor or his Surety Company will pay the excess. These damages may be waived at the option of the County.

44. AFFIRMATIVE ACTION REQUIREMENTS

EXHIBIT B (Revised 4/10)

MANDATORY EQUAL EMPLOYMENT OPPORTUNITY LANGUAGE N.J.S.A. 10:5-31 et seq. (P.L. 1975, C. 127) N.J.A.C. 17:27

CONSTRUCTION CONTRACTS

During the performance of this contract, the contractor agrees as follows:

The contractor or subcontractor, where applicable, will not discriminate against any employee or applicant for employment because of age, race, creed, color, national origin, ancestry, marital status, affectional or sexual orientation, gender identity or expression, disability, nationality or sex. Except with respect to affectional or sexual orientation and gender identity or expression, the contractor will ensure that equal employment opportunity is afforded to such applicants in recruitment and employment, and that employees are treated during employment, without regard to their age, race, creed, color, national origin, ancestry, marital status, affectional or sexual orientation, gender identity or expression, disability, nationality or sex. Such equal employment opportunity shall include, but not be limited to the following: employment, up-grading, demotion, or transfer; recruitment or recruitment advertising; layoff or termination; rates of pay or other forms of compensation; and selection for training, including apprenticeship. The contractor agrees to post in conspicuous places, available to employees and applicants for employment, notices to be provided by the Public Agency Compliance Officer setting forth provisions of this nondiscrimination clause.

The contractor or subcontractor, where applicable will, in all solicitations or advertisements for employees placed by or on behalf of the contractor, state that all qualified applicants will receive consideration for employment without regard to age, race, creed, color, national origin, ancestry, marital status, affectional or sexual orientation, gender identity or expression, disability, nationality or sex.

The contractor or subcontractor will send to each labor union, with which it has a collective bargaining agreement, a notice, to be provided by the agency contracting officer, advising the labor union or workers' representative of the contractor's commitments under this act and shall post copies of the notice in conspicuous places available to employees and applicants for employment.

The contractor or subcontractor, where applicable, agrees to comply with any regulations promulgated by the Treasurer, pursuant to N.J.S.A. 10:5-31 et seq., as amended and supplemented from time to time and the Americans with Disabilities Act.

When hiring or scheduling workers in each construction trade, the contractor or subcontractor agrees to make good faith efforts to employ minority and women workers in each construction trade consistent with the targeted employment goal prescribed by N.J.A.C. 17:27-7.2; provided, however, that the Division may, in its discretion, exempt a contractor or subcontractor from

compliance with the good faith procedures prescribed by the following provisions, A, B and C, as long as the Division is satisfied that the contractor or subcontractor is employing workers provided by a union which provides evidence, in accordance with standards prescribed by the Division, that its percentage of active "card carrying" members who are minority and women workers is equal to or greater than the targeted employment goal established in accordance with N.J.A.C. 17:27-7.2. The contractor or subcontractor agrees that a good faith effort shall include compliance with the following procedures:

(A) If the contractor or subcontractor has a referral agreement or arrangement with a union for a construction trade, the contractor or subcontractor shall, within three business days of the contract award, seek assurances from the union that it will cooperate with the contractor or subcontractor as it fulfills its affirmative action obligations under this contract and in accordance with the rules promulgated by the Treasurer pursuant to N.J.S.A. 10:5-31 et. seq., as supplemented and amended from time to time and the Americans with Disabilities Act. If the contractor or subcontractor is unable to obtain said assurances from the construction trade union at least five business days prior to the commencement of construction work, the contractor or subcontractor agrees to afford equal employment opportunities minority and women workers directly, consistent with this chapter. If the contractor's or subcontractor's prior experience with a construction trade union, regardless of whether the union has provided said assurances, indicates a significant possibility that the trade union will not refer sufficient minority and women workers consistent with affording equal employment opportunities as specified in this chapter, the contractor or subcontractor agrees to be prepared to provide such opportunities to minority and women workers directly, consistent with this chapter, by complying with the hiring or scheduling procedures prescribed under (B) below; and the contractor or subcontractor further agrees to take said action immediately if it determines that the union is not referring minority and women workers consistent with the equal employment opportunity goals set forth in this chapter.

(B) If good faith efforts to meet targeted employment goals have not or cannot be met for each construction trade by adhering to the procedures of (A) above, or if the contractor does not have a referral agreement or arrangement with a union for a construction trade, the contractor or subcontractor agrees to take the following actions:

(1) To notify the public agency compliance officer, the Division, and minority and women referral organizations listed by the Division pursuant to N.J.A.C. 17:27-5.3, of its workforce needs, and request referral of minority and women workers;

(2) To notify any minority and women workers who have been listed with it as awaiting available vacancies;

(3) Prior to commencement of work, to request that the local construction trade union refer minority and women workers to fill job openings, provided the contractor or subcontractor has a referral agreement or arrangement with a union for the construction trade;

(4) To leave standing requests for additional referral to minority and women workers with the local construction trade union, provided the contractor or subcontractor has a referral agreement or arrangement with a union for the construction trade, the State Training and Employment Service and other approved referral sources in the area;

(5) If it is necessary to lay off some of the workers in a given trade on the construction site, layoffs shall be conducted in compliance with the equal employment opportunity and non-discrimination standards set forth in this regulation, as well as with applicable Federal and State court decisions;

(6) To adhere to the following procedure when minority and women workers apply or are referred to the contractor or subcontractor:

(i) The contractor or subcontractor shall interview the referred minority or women worker.

(ii) If said individuals have never previously received any document or certification signifying a level of qualification lower than that required in order to perform the work of the construction trade, the contractor or subcontractor shall in good faith determine the qualifications of such individuals. The contractor or subcontractor shall hire or schedule those individuals who satisfy appropriate qualification standards in conformity with the equal employment opportunity and non-discrimination principles set forth in this chapter. However, a contractor or subcontractor shall determine that the individual at least possesses the requisite skills, and experience recognized by a union, apprentice program or a referral agency, provided the referral agency is acceptable to the Division. If necessary, the contractor or subcontractor shall hire or schedule minority and women workers who qualify as trainees pursuant to these rules. All of the requirements, however, are limited by the provisions of (C) below.

(iii) The name of any interested women or minority individual shall be maintained on a waiting list, and shall be considered for employment as described in (i) above, whenever vacancies occur. At the request of the Division, the contractor or subcontractor shall provide evidence of its good faith efforts to employ women and minorities from the list to fill vacancies.

(iv) If, for any reason, said contractor or subcontractor determines that a minority individual or a woman is not qualified or if the individual qualifies as an advanced trainee or apprentice, the contractor or subcontractor shall inform the individual in writing of the reasons for the determination, maintain a copy of the determination in its files, and send a copy to the public agency compliance officer and to the Division.

(7) To keep a complete and accurate record of all requests made for the referral of workers in any trade covered by the contract, on forms made available by the Division and submitted promptly to the Division upon request.

(C) The contractor or subcontractor agrees that nothing contained in (B) above shall preclude the contractor or subcontractor from complying with the union hiring hall or apprenticeship policies in any applicable collective bargaining agreement or union hiring hall arrangement, and, where required by custom or agreement, it shall send journeymen and trainees to the union for referral, or to the apprenticeship program for admission, pursuant to such agreement or arrangement. However, where the practices of a union or apprenticeship program will result in the exclusion of minorities and women or the failure to refer minorities and women consistent with the targeted county employment goal, the contractor or subcontractor shall consider for employment persons referred pursuant to (B) above without regard to such agreement or arrangement; provided further, however, that the contractor or subcontractor shall

not be required to employ women and minority advanced trainees and trainees in numbers which result in the employment of advanced trainees and trainees as a percentage of the total workforce for the construction trade, which percentage significantly exceeds the apprentice to journey worker ratio specified in the applicable collective bargaining agreement, or in the absence of a collective bargaining agreement, exceeds the ratio established by practice in the area for said construction trade. Also, the contractor or subcontractor agrees that, in implementing the procedures of (B) above, it shall, where applicable, employ minority and women workers residing within the geographical jurisdiction of the union.

After notification of award, but prior to signing a construction contract, the contractor shall submit to the public agency compliance officer and the Division an initial project workforce report (Form AA 201) electronically provided to the public agency by the Division, through its website, for distribution to and completion by the contractor, in accordance with N.J.A.C. 17:27-7. The contractor also agrees to submit a copy of the Monthly Project Workforce Report once a month thereafter for the duration of this contract to the Division and to the public agency compliance officer.

The contractor agrees to cooperate with the public agency in the payment of budgeted funds, as is necessary, for on-the-job and/or off-the-job programs for outreach and training of minorities and women.

(D) The contractor and its subcontractors shall furnish such reports or other documents to the Division of Public Contracts Equal Employment Opportunity Compliance as may be requested by the Division from time to time in order to carry out the purposes of these regulations, and public agencies shall furnish such information as may be requested by the Division of Public Contracts Equal Employment Opportunity Compliance for conducting a compliance investigation pursuant to **Subchapter 10 of the Administrative Code (NJAC 17:27)**.

[REMAINDER OF PAGE INTENTIONALLY LEFT BLANK]

45. INVESTMENT ACTIVITIES IN IRAN

Pursuant to P.L. 2012, c.25, codified as NJSA 2:32-55 *et seq*, prohibits State and local public contracts with persons or entities engaging in certain investment activities in energy or finance sectors of Iran.

46. COMPLIANCE WITH THE PUBLIC WORKS CONTRACTOR REGISTRATION ACT - (NJSA 34:11-56.48 *et. seq.*)

Pursuant to the above-referenced law, Bidders are required to be registered with the New Jersey Department of Labor and to possess a current certificate by said Department indicating compliance with the Act prior to the time and date that bids are received. Bidders are notified of this requirement of their compliance. Such certificates or applications shall also be provided for each Subcontractor furnishing plumbing and gas fitting, steam and hot water heating and ventilating apparatus, and all kindred work, steam power plants and kindred work, electrical work, structural steel and ornamental iron work, and such other subcontractors as the specifications require relative to prior identification.

47. UTILITIES

Attention of the bidder is directed to the fact that the approximate locations of known utility structures and facilities that may be encountered within and adjacent to the limits of the Work are shown on the plans and described herein. The accuracy and completeness of this information is not guaranteed by the County Engineer and the bidder is advised to ascertain for himself all the facts concerning the location of these and other utilities.

The Contractor will not proceed with his Work until he has made diligent inquiries of all public utility and municipal officials to determine the exact location of all underground structures and pipes within the site of the Project. The Contractor will notify utility owners not less than ten (10) days in advance of the time he proposes to perform any Work that will endanger or affect their facilities in compliance with **New Jersey One-Call**. In excavating in any part of the Work, care must be taken not to remove or damage any gas, water, sewer, or other pipe, conduit, or structure, - public or private - without the concurrence of the owner and the County Engineer. The Contractor will, at his own expense, shore up, secure and maintain a continuous flow in such structures, and will keep them in repair until final acceptance of the Work.

When pipes or other structures are encountered or when the removal, relocation or protection of these utilities are necessary in carrying out the Project as planned, the Contractor will cooperate with the owner of said utilities and will permit the owners or their agents access to the site of the Work in order to relocate or protect their facilities and not hinder or delay unnecessarily the Work of the owners in moving same. No extra

allowance of payment will be made to the Contractor for the use of any materials, equipment, etc., or for the performance of any Work in connection with the moving of said structures unless the Contractor is specifically ordered by the County Engineer to furnish such materials, equipment, or services. If directed by the County Engineer to do any Work or furnish any materials or equipment, payment will be allowed the Contractor in accordance with the unit prices bid for such Work, or, if such items are not scheduled in the proposal, such Work shall be allowed "Supplemental Work" as provided in Section 39 of these general specifications. The corporations, companies, agencies or municipalities owning or controlling the utilities, and the name, and telephone numbers are listed in the beginning of the Technical Specifications.

48. MATERIAL COMPLIANCE AND SHOP DRAWINGS

The Contractor will require the manufacturer or supplier to furnish three (3) copies of Certification of Compliance with each delivery of materials, components and manufactured items for the Project. Two (2) copies will be furnished to the County Engineer; one copy will be retained by the Contractor. Certificates of Compliance will contain the following information:

1. Project to which material is consigned;
2. Name of the Contractor to which the material is supplied;
3. Kind of material supplied;
4. Quantity of material represented by the Certificate;
5. Means of identifying the consignment, such as label marking, seal number, etc.;
6. Date and method of shipment;
7. That the material is in conformity with the pertinent specifications stated in the certificate; and
8. Signature of a person having legal authority to bind the supplier.

The Contractor will submit to the County Engineer for his approval five (5) copies of complete and fully detailed shop or working drawings for those items listed in the beginning of the technical specifications.

Each drawing will identify the name of the job, location and Contractor.

All drawings will be approved in accordance with the standard specifications. Refer to the Technical Specifications for specific items.

All materials or articles used in the Work will be of American manufacture, insofar as same are available, in conformance with N.J.S.A. 40A:11-18.

49. PRECONSTRUCTION

In order to provide full coordination of this Project among the parties concerned, the County Engineer will arrange for a preconstruction meeting between the Contractor, County Engineer and other interested parties as soon as possible after the contract is executed. At this meeting the Contractor will present his proposed schedule of Work which shall be subject to review and approval of the County through its designated representatives.

50. DISPUTES UNDER THE CONTRACT

A dispute arising under the Contract shall be submitted in writing to the County Engineer with all facts and supporting data. The County Engineer will review the dispute and issue his decision or request additional facts or documentation after which he will render his decision.

In the event the dispute is not then resolved, the matter shall, pursuant to law, be submitted to mediation before being submitted to a court of competent jurisdiction venued in Union County.

The County Engineer will notify the County Counsel when a matter is to be submitted to mediation. The County Counsel will communicate with the parties and inform them of the procedures to be followed in making such a submission.

[REMAINDER OF PAGE INTENTIONALLY LEFT BLANK]

**51. RESOLUTION NO. 2014-0408 ADOPTED ON MAY 8, 2014
BY THE UNION COUNTY BOARD OF CHOSEN FREEHOLDERS**

In addition to compliance with the New Jersey Prevailing Wage Act, the Contractor shall comply with the requirement as set forth in Resolution No. 2014-0408 adopted on May 8, 2014 by the Union County Board of Chosen Freeholders.

**UNION COUNTY BOARD OF CHOSEN FREEHOLDERS RESOLUTION NO. 2014-0408
DATED: 05/08/2014**

WHEREAS, the County of Union recognizes there is a need to ensure that all work on significant public construction and maintenance contracts is performed by responsible, qualified firms that maintain the capacity, expertise, personnel, and other qualifications and resources necessary to successfully perform public contracts in a timely, reliable, and cost-effective manner; and

WHEREAS, in order to effectuate the purpose of selecting responsible contractors for significant public contracts and to protect Union County's capital investments in such contracts prospective contractors and subcontractors should be required to meet pre-established, clearly-defined, minimum standards relating to contractor responsibility, including requirements and criteria concerning qualifications, competency, expertise, adequacy of resources, including equipment, financial and personnel, and satisfactory records regarding past project performance, safety, legal compliance and business integrity; and

WHEREAS, the County has a compelling interest in assuring that its Public Works Projects meet the highest standard of safety and quality; and

WHEREAS, due to the critical impact that skilled construction craft labor has on public works projects, and due to the limited availability of skilled construction craft labor and imminent craft labor skill shortages, it is necessary to require contractors and subcontractors to participate in established, formal apprenticeship training programs for the purpose of both promoting successful project delivery and ensuring future workforce development; and

WHEREAS, an apprenticeship program is a structured system of training designed to prepare individuals for occupations and life long careers in skilled trades and crafts by providing a wage-paying job that incorporates extensive workplace and classroom training under the supervision of experienced workers, in preparation for highly skilled occupations; and

WHEREAS, apprenticeship programs are a critical component in public safety, by ensuring that workers on public projects are properly trained, able, competent and capable craftsmen, and provide assurance of compliance with the County's bid specifications and achieve high quality standards; and

WHEREAS, for an apprenticeship program to be fully effective, the public and private sectors must recognize its value and commit to supporting its mission; and

WHEREAS, Union County has long recognized the value of apprenticeship programs through its support of the Union County Vocational-Technical Schools, which offer training programs to help ensure that Union County will continue to produce a skilled

and educated work force in the trade specialties, and thus, strengthen Union County's economy by fostering the development of highly paid trade and craft careers; and

WHEREAS, the use of apprenticeship programs or apprenticeship trained employees on Union County Public Works Projects will serve the dual goal of providing the County with assurance that its public works projects are completed with a well-trained workforce, in a highly skilled and timely fashion, while creating opportunities for careers in the skilled trades and craft industry for County residents.

WHEREAS, the County of Union also recognizes that it is beneficial to their employees to utilize fair business, employment, and training practices that have a positive impact on local communities affected by such contracts.

NOW, THEREFORE, BE IT RESOLVED by the Board of Chosen Freeholders of the County of Union as follows:

1. The County of Union shall require compliance with the provisions of this Resolution by business entities seeking to provide services to the County of Union as specified herein. The requirements of this Resolution are intended to supplement, not replace, existing contractor qualifications and performance standards or criteria currently required by law, public policy or contracting documents, including but not limited to Union County's DPMC classification and Project Labor Agreement policies
2. All contractors and subcontractors that perform significant work on any public facility or public works project, including construction, alteration, renovation, repair, service, or maintenance work, shall meet the requirements of this Resolution. For purposes of this Resolution, the term "significant work" shall be defined as any work or activity covered under the New Jersey Prevailing Wage Act, N.J.S.A. 34:11-56.25 et seq.
3. All firms engaged in contracts covered by this Resolution shall be qualified responsible contractors or subcontractors that have sufficient capabilities in all respects to successfully perform contracts on which they are engaged, including the necessary experience, equipment, technical skills and qualifications and organizational, financial and personnel resources. Firms bidding on public contracts shall also be required to have a satisfactory past performance record and a satisfactory record of legal compliance, integrity and business ethics. Compliance with these standards shall be established by compliance with the requirements set forth in paragraph 8 of this Resolution.
4. As a condition of performing work on public works contracts over the public works threshold, the general contractor shall provide certification that he and each subcontractor working on the project shall have at least one (1) employee who has successfully completed the OSHA 10-hour construction safety and health course. As a condition of performing work on public works contracts of \$500,000.00 or more total cost of project, the general contractor shall provide certification that each subcontractor working on the project shall

have at least one (1) employee who has successfully completed the OSHA 30-hour construction safety and health course.

5. All contractors and subcontractors that perform significant work on any public facility or public works project shall be required to affirmatively provide evidence of and confirm compliance with proof of participation in an Apprenticeship Program currently registered and approved by the United States Department of Labor (“USDOL”), the New Jersey Department of Labor (“NJDOL”) or any state having equal to or higher requirements as either the USDOL or NJDOL apprenticeship programs. Additionally, Apprenticeship Programs shall meet the criteria set forth in Section 8(i) of this Resolution.

6. As a condition of performing work on public works contracts subject to this Resolution, a general contractor seeking award of a contract shall submit a Contractor Responsibility Certification at the time it submits its bid for contract.

7. The Contractor Responsibility Certification shall be completed on a form provided by the Union County Purchasing Department and shall reference the project for which a bid is being submitted by name and contract or project number.

8. In the Contractor Responsibility Certification, general contractors and subcontractors shall certify the following facts regarding their past performance and work history and its current qualifications and performance capabilities:

a. The firm has all valid, effective licenses, registrations or certificates required by federal, state, county, or local law, including, but not limited to, licenses, registrations, certificates required to: (1) do business in the designated locale; and (2) perform the contract work it seeks to perform. These shall include, but not be limited to, licenses, registrations or certificates for any type of trade work or specialty work, which the firm proposes to self-perform.

b. The firm meets the bonding requirements for the contract, as required by applicable law or contract specifications and any insurance requirements, as required by applicable law or contract specifications, including general liability insurance, workers compensation insurance and unemployment insurance requirements.

c. The firm has not been debarred by any federal, state or local government agency or authority in the past three (3) years.

d. The firm has not defaulted on any project in the past three (3) years.

e. The firm has not had any type of business, contracting or trade license, registration, or other certification suspended or revoked in the past three (3) years.

f. The firm has not been cited and found guilty for a willful violation of federal or state safety laws in the past three (3) years.

g. The firm and/or its owners have not been convicted of any crime relating to the contracting business by a final decision of a court or government agency in the past three (3) years.

h. The firm will pay all craft employees that it employs on the project the current wage rates and benefits as required under applicable Federal or State prevailing wage laws.

i. The firm participates in an Apprenticeship Program that is currently registered with the USDOL, the NJDOL or any state having equal to or higher requirements as either the USDOL or NJDOL apprenticeship programs, for each craft or trade in which it apprentices. The firm shall provide proof of meeting this qualification standard by submitting appropriate documentation as an attachment to this Certification. The firm shall continue to participate in applicable apprenticeship programs for the full duration of the contract work. The apprenticeship program in which the firm participates shall have graduated at least one (1) enrollee in each of the past three (3) years.

9. The County of Union may conduct any additional inquiries to verify that the prospective awardee and its subcontractors have the technical qualifications and performance capabilities necessary to successfully perform the contract and that the firms have a sufficient record of legal compliance and business integrity to justify the award of a public contract. In conducting such inquiries, the County of Union may seek relevant information from the firm, its prior clients or customers, its subcontractors or any other relevant source.

10. If any provision of this Resolution shall be held to be invalid or unenforceable by a court of competent jurisdiction, any such holding shall not invalidate any other provisions of this Resolution and all remaining provisions shall remain in full force and effect.

NOW, THEREFORE, BE IT RESOLVED by the Board of Chosen Freeholders of the County of Union that it hereby establishes and adopts the Responsible Contractor Policy, and it hereby authorizes the County Manager to sign any and all documents necessary to make said Policy effective immediately.

52. CONTRACTOR BUSINESS REGISTRATION CERTIFICATE New Mandatory Requirement -Effective 1/18/2010

The recently enacted **P.L. 2009, c.315**, requires that effective January 18, 2010; a contracting agency must receive proof of the bidder's business registration prior to the award of a contract. However, the proof must show that the bidder was in fact registered with the State of New Jersey Department of the Treasury, Division of Revenue and obtained the business registration prior to the receipt of bids.

If subcontractors are named on the bid, proof of the business registration for each subcontractor must be provided prior to the award of bid. Similarly to the bidder, the proof must show that each subcontractor was registered with the State of New Jersey Department of the Treasury, Division of Revenue and obtained the business registration prior to the receipt of bids.

Proof of business registration shall be

- A copy of a Business Registration Certificate issued by the Department of the Treasury, Division of Revenue; or
- A copy of the web version provided by the NJ Division of Revenue, or

Register online at <http://www.state.nj.us/treasury/revenue/busregcert.htm>. Click the "online" link and then select "Register for Tax and Employer Purposes or call the Division at 609-292-1730.

Note: A NJ Certificate of Authority is not acceptable.

FAILURE to submit proof of registration of the bidder or any subcontractor named on the bid prior to the award of contract shall be cause to reject the bid.

FAILURE of the bidder or any subcontractor named on the bid to be registered prior to the receipt of bids is cause for a **MANDATORY REJECTION** of bids. (A NON-WAIVABLE DEFECT). This covers construction Work as well as non-construction bids.

IN ADDITION:

N.J.S.A. 52:32-44 imposes the following requirements on Contractors and all subcontractors that knowingly provide goods or perform services for a Contractor fulfilling this contract:

- 1) the Contractor shall provide written notice to its subcontractors and suppliers to submit proof of business registration to the Contractor;
- 2) subcontractors through all tiers of a project must provide written notice to their subcontractors and suppliers to submit proof of business registration and subcontractors shall collect such proofs of business registration and maintain them on file;

- 3) prior to receipt of final payment from a contracting agency, the Contractor must submit to the contacting agency an accurate list of all subcontractors and suppliers or attest that none was used; and,
- 4) during the term of this contract, the Contractor and its affiliates shall collect and remit, and shall notify all subcontractors and their affiliates that they must collect and remit, to the Director, New Jersey Division of Taxation, the use tax due pursuant to the Sales and Use Tax Act, (*N.J.S.A. 54:32B-1 et seq.*) on all sales of tangible personal property delivered into this State.

A Contractor, subcontractor or supplier who fails to provide proof of business registration or provides false business registration information shall be liable to a penalty of \$25 for each day of violation, not to exceed \$50,000 for each business registration copy not properly provided or maintained under a contract with a contracting agency. Information on the law and its requirements are available by calling (609) 292-9292.

[REMAINDER OF PAGE INTENTIONALLY LEFT BLANK]

53. BID PROTEST – LEGAL FEES AND COSTS

In the event a Bidder unsuccessfully challenges a Bid Submission by filing an action in a court of law concerning same, said Bidder shall be responsible for payment of reasonable legal costs and fees incurred by the County relating to said protest.

54. AMERICAN GOODS AND PRODUCTS WHERE POSSIBLE

Bidder shall comply with the requirements of NJSA 40A:11-18 and use only manufactured and farm products of the United States, wherever available, for the Project.

55. NEW JERSEY PAY-TO-PLAY REQUIREMENTS

This Contract is required by law to be publicly advertised for bids. As such, lists of political contributions pursuant to NJSA 19A:44A-1 et. seq. are NOT REQUIRED to be provided with the bids.

56. STATEMENT OF EQUIPMENT TO BE USED IN CONSTRUCTION

Pursuant to NJSA 40A:11-20 entitled Certificate of Bidder Showing Ability to Perform Contract, the County requires a Certification from all bidders submitting a bid showing that the Bidder owns, leases, or controls all necessary equipment required by the Project Plans and Specifications. All bidders shall provide this information at the time of the bid opening using the attached form entitled, "CERTIFICATE OF BIDDER SHOWING ABILITY TO PERFORM CONTRACT".

If the Bidder is not the actual owner of the equipment, it shall state the source from which the equipment will be obtained and shall attach a certificate from the owner or person in control of the equipment demonstrating that the equipment owner has granted the Bidder control of the requisite equipment during such time as may be necessary for completion of the portion of the contract for which the equipment is necessary.

57. NEW JERSEY SALES AND USE TAX REQUIREMENTS,

Contractors are required to comply with the following:

New Jersey Sales and Use Tax Requirements: All contractors with subcontractors, or any of their affiliates, who enter into contracts for the provision of goods or services with or for New Jersey local government entities, are required to collect and remit to the New Jersey Director of Taxation in the Department of the Treasury the use tax due on all of their sales of tangible personal property delivered into the State of New Jersey

pursuant to the "Sales and Use Tax Act," (NJSA 54:32B-1 et, seq.), regardless of whether the tangible personal property is intended for a contract with the contracting agency. This tax shall be remitted for the term of the Contract.

For purposes herein "affiliate" shall mean any entity that: (a) directly, indirectly, or constructively controls another entity, (b) is directly, indirectly, or constructively controlled by another entity, or (c) is subject to the control of a common entity. For purposes of the immediately preceding sentence, an entity controls another entity if it owns, directly or indirectly, more than fifty percent (50%) of the ownership interest in that entity. NJSA 52:32-44(g)(3).

ALFRED J. FAELLA
COUNTY MANAGER

MICHAEL M. YUSKA, DIRECTOR
DIVISION OF PURCHASING

BID DOCUMENT SUBMISSION CHECKLIST

ALL SIGNATURES AND SEALS SHALL BE ORIGINALS UNLESS OTHERWISE SPECIFIED
BID SHEETS SHOULD NOT BE SUBMITTED DOUBLE SIDED PAGES, (SINGLE SIDE ONLY)

EACH BIDDER SHOULD COMPLETE THIS FORM AND INITIAL EACH ENTRY.

DATE COMPLETED: _____

IN ACCORDANCE WITH THE BID SPECIFICATIONS I HAVE REVIEWED, COMPLETED / EXECUTED AND INCLUDED THE FOLLOWING FORMS:

_____ Bid Form Page (**Signed, Dated and Bid on all alternatives applicable to the Work**).

_____ Security in the form of:

_____ Bid bond in an amount equal to 10% of the total amount of this bid not to exceed \$20,000.00; or

_____ Certified check or cashier's check in the amount of 10% of this bid not to exceed \$20,000.00

_____ Consent of Surety form signed by a Surety Company if the total amount of your Bid is over \$36,000.00. If your bid is accepted, the Surety Company that provided the Consent shall be required to furnish a Performance, Labor and Materials Bond in the amount of 100% of the award of the contract.

The County of Union has provided its Consent of Surety form for your use. The use of this form by your Surety Company will expedite the bid review process and eliminate the possibility of having your bid rejected. If, however, you should need to use another form, please use language similar to that used on the Union County form and avoid making any additions or deletions to the Union County form language. In lieu of the Consent of Surety you may submit a Certified Check in the full amount of the bid.

_____ STATEMENT OF BIDDER OWNERSHIP. Pursuant to N.J.S.A. 52:25-24.2, which includes **BOTH** of the following documents:

- Bidder Signature Page
- Bidder Disclosure Statement (**Fill out 2 pages completely**)

_____ SUBCONTRACTOR IDENTIFICATION. Pursuant to N.J.S.A. 40A:11-16, which includes **BOTH** of the following documents:

- Subcontractor Identification Statement: List of Subcontractors (**only for certain types of work**)
- Subcontractor Identification Certification

_____ Acknowledgement of Addendum form: (**This form is to be used only when an addendum has been added to the specifications**).

_____ A copy of the State of New Jersey Department of the Treasury, Division of Revenue, **Business Registration Certificate ("BRC")** should be included with the bids as it must be received by the County prior to the award of the contract. The BRC provided must show that the Bidder was registered at the time of receipt of bids or the bid will be rejected.

_____ A copy of the State of New Jersey Department of the Treasury, Division of Revenue, **Business Registration Certificate ("BRC")** of all named or listed subcontractors (List of Subcontractors) in a Construction bid should be included with the bid as the BRC(s) must be received by the County prior to the award of the contract. Each subcontractor's certificate provided must show that the subcontractor was registered at the time of the receipt of bids or the bid will be rejected.

- _____ Affirmative Action Requirement
- _____ Experience Statement
- _____ Certificate of Bidder showing ability to perform Contract
- _____ Non-Collusion Affidavit – Fill out completely and notarize
- _____ Certificates from New Jersey Department of Labor – Public Works Contractor Registration Act. **(Only for certain types of work)**
- _____ Federal Attachments **(If applicable)**
- _____ NJDPMC Certificate / Notice of Classification **(If applicable)**
- _____ Americans with Disabilities Act
- _____ Contractor Responsibility Certification
- _____ Affidavit of General Contractor and Subcontractor OSHA Compliance
- _____ Statement of Bidder's Qualifications
- _____ Contractor Performance Record
- _____ Affidavit Regarding List of Debarred, Suspended or Disqualified Bidders
- _____ Prior Negative Experience Questionnaire
- _____ Contractor's Certification of Compliance – New Jersey Prevailing Wage Act
- _____ Uncompleted Contracts Affidavit **(For Bidder, if applicable) MUST ALSO PROVIDE DPMC FORM 701**
- _____ Certificate of Insurance Statement
- _____ Collection of Use Tax on Sales to Local Government Statement
- _____ Time of Completion
- _____ Disclosure of Investment Activities in Iran form

I HAVE TAKEN THE FOLLOWING ACTIONS:

- _____ Visited the site and attended the Pre-Bid Meeting **(Where applicable)**
- _____ Reviewed the Contract Documents (including any permits the County or its professionals may have obtained), Work, Site, Locality, and Local Conditions and Laws and Regulations that in any manner may affect Cost, Progress, Performance or Furnishing of Work.
- _____ Reviewed Bond Requirements
- _____ Provided Proof of Compliance with New Jersey Prevailing Wage Act
- _____ Reviewed Form of Owner/Contractor Agreement and General Conditions to the Contract

NOTE: QUESTIONS PERTAINING TO THIS BID ARE TO BE DIRECTED TO DIVISION OF ENGINEERING AT 908-789-3675

BIDDING DOCUMENTS

The Bidding Documents consist of the following items:

- **ADDENDA, if issued**
- **CLARIFICATIONS, if issued**
- **INSTRUCTION TO BIDDERS**
- **BID FORM**
- **OWNER-CONTRACTOR AGREEMENT (AIA 101) AND GENERAL CONDITIONS (AIA 201)**
- **SPECIFICATIONS:** As outlined in the Table of Contents and included in the Project Manual.
- **DRAWINGS:** As per List of Drawings, indicated on the Project Title Sheet.

Bidder's Name _____

BID FORM

I/We have carefully examined the plans, specifications, and advertisement for bid for the

**GALLOPING HILL GOLF CART PATH IMPROVEMENT PROJECT
BOROUGH OF KENILWORTH, COUNTY OF UNION, NEW JERSEY
BA #59-2015; Union County Engineering Project #2015-014**

that is on file in the Union County Division of Engineering. I/We have inspected the site of the work and will contract to do all the work and furnish all materials mentioned in said plans and specifications. Work will be accomplished in the manner prescribed therein.

BASE BID ITEMS:

ITEM	DESCRIPTION	UNITS	CONTRACT QUANTITY	UNIT PRICE	AMOUNT
1	Excavation Unclassified	C.Y.	700		
2	Dense Graded Aggregate Base Course, 4" Thick	TON	800		
3	Hot Mix Asphalt Milling, 3" or Less	S.Y.	39,000		
4	Hot Mix Asphalt 9.5M64 Surface Course, 2 1/2" Thick	TON	5,900		
5	Asphalt Price Adjustment	ALLOWANCE	ALLOWANCE	\$20,000.00	\$20,000.00
6	6" X 8" Hot Mix Asphalt Curb	L.F.	10,800		
7	NDS Pro Series 5" Deep Profile Channel Drain, Class D Load Application with ADA Compliant Ductile Channel Grate, 5" Deep Profile End Outlet and 5' Deep Profile End Cap or Approved Equal	L.F.	60		
8	Topsoiling, 4" Thick	S.Y.	8,000		
9	Fertilizing & Seeding, Type A-3	S.Y.	6,500		

Bidder's Name _____

Written

Figures

BID CONTINGENCY: (To be used if and when directed by the County)

SEVENTY FIVE THOUSAND DOLLARS
Written

\$75,000.00
Figures

TOTAL BASE BID ITEMS PLUS BID CONTINGENCY AMOUNT:

Written

Figures

NOTE: Bid Contingency may include one-half of one percent of contract amount set aside for local training if and when directed by the County.

Bidder's Name_____

CONSENT OF SURETY
TO ACCOMPANY PROPOSAL (BID)

_____ (hereinafter called Surety), organized and existing under the laws of the State of _____ duly authorized and qualified to transact business in the State of New Jersey, in consideration of the sum of One Dollar (\$1.00), lawful money of the United States of America, to it in hand paid, receipt whereof is hereby acknowledged, and in consideration, hereby certifies and agrees that if the contract for which the attached proposal is made be awarded to _____ (hereinafter called Contractor) for the performance of certain work and labor or the supplying of certain materials, or both, as more particularly set forth in said proposal and described for purposes of this instrument as a proposal for _____ to the COUNTY OF UNION and if Contractor shall enter into the contract, Surety will become bound as surety for its faithful performance, labor and material payment and will provide the Contractor with a performance, labor and material payment bond in the full amount of the contract price.

NOTE:
Expiration date
Needed if Annual
Surety

NAME OF INSURANCE COMPANY
ADDRESS: _____

ORIGINAL SIGNATURE
ATTORNEY-IN-FACT FOR INSURANCE CO.

NOTE: PROOF OF AUTHORITY OF OFFICERS OF SURETY COMPANY TO EXECUTE THIS DOCUMENT MUST BE SUBMITTED.

BIDDER SIGNATURE PAGE

THE BIDDER MUST READ THE FOLLOWING INSTRUCTIONS TO COMPLETE THIS PAGE:

1. If doing business under a **trade name, partnership or a sole proprietorship**, you must submit the bid under exact title of the trade name, partnership, or proprietorship, and the bid must be signed by either the **owner**, or a **partner** and **witnessed** by a **notary public**.
2. If a **Corporation**, the bid must be signed by the **President** or **Vice President** and **witnessed** by a **Corporate Secretary** (corporate title must be exact) and **affix corporate seal**. If a Corporate Secretary does not exist, President or Vice President's signature shall be witnessed by a Notary Public.
3. Other persons **authorized** by **corporate resolution** to execute agreements in its behalf may also sign the bid documents (pages). **Copy of a resolution must accompany the bid.**
4. The person who signs this bid form **must also** sign the **Non-Collusion Affidavit**.
5. You **cannot** witness your own signature.

NAME OF BIDDER

ADDRESS OF BIDDER

**ORIGINAL SIGNATURE
CORPORATE SECRETARY**

**PRINT NAME AND TITLE
CORPORATE SECRETARY**

TEL: _____
FAX: _____
E-Mail: _____

BY: _____
ORIGINAL SIGNATURE

Corporate Seal

PRINT OR TYPE NAME AND TITLE

WARNING: IF YOU FAIL TO FULLY, ACCURATELY, AND COMPLETELY SUPPLY THE INFORMATION REQUESTED ON THIS PAGE, YOUR BID MAY BE REJECTED.

Bidder's Name _____

BIDDER DISCLOSURE STATEMENT

N.J.S.A. 52:25-24.2 (P.L. 1977 c. 33)

Failure of the bidder/respondent to submit the required information is cause for automatic rejection.

CHECK ONE

I certify that the list below contains the names and home addresses of all stockholders holding 10% or more of the issued and outstanding stock of the undersigned.

OR

I certify that no one stockholder owns 10% or more of the issued and outstanding stock of the undersigned.

LEGAL NAME OF BIDDER: _____

Check the box that represents the type of business organization:

Partnership

Corporation

Sole Proprietorship

Limited Partnership

Limited Liability Company

Limited Liability Partnership

Subchapter S Corporation

Complete if the bidder/respondent is one of the 3 types of corporations:

Date Incorporated: _____ **Where Incorporated:** _____

BUSINESS ADDRESS:

Street Address	City	State	Zip Code
-----------------------	-------------	--------------	-----------------

Telephone #	Fax #
--------------------	--------------

Pursuant to N.J.S.A. 52:25-24.2, also referred to as P.L. 1977, c. 33, no corporation or partnership shall be awarded any contract for the performance of any work or the furnishing of any materials or supplies, unless, prior to the receipt of the bid or accompanying the bid of said corporation or partnership, there is submitted a statement setting forth the names and addresses of all stockholders in the corporation or partnership who own ten (10) percent or more of its stock of any class, or of all individual partners in the partnership who own a ten (10) percent or greater interest therein. Further, the Attorney General has concluded that the provisions of N.J.S.A. 52:25-24.2, in referring to corporations and partnerships, are intended to apply to all forms of business entities, including, but not limited to, corporations, limited partnerships, limited liability companies, limited liability partnerships, Subchapter S corporations, partnerships and sole proprietorships.

Bidders are required to disclose whether they are a partnership, corporation, limited liability company or sole proprietorship. The Stockholder Disclosure Certification form shall be completed, signed and notarized. Failure of the bidder to submit the required information is cause for automatic rejection of the bid.

BIDDER DISCLOSURE STATEMENT – (Continued)

N.J.S.A. 52:25-24.2, also referred to as **P.L. 1977, Ch. 33**, requires all corporate, limited liability and partnership bidders for state, county, municipal or school district contracts to submit a list of names and addresses of all stockholders owning 10% or more of their stock or 10% or more of the stock of the corporate stockholders or in the case of partnership or limited liability company, the names and addresses of those partners or owners owning 10% or greater interest in the partnership or limited liability company. Furthermore, the Union County Board of Chosen Freeholders requires a statement from all Bidders, which must indicate all Principals of Bidders.

You must set forth the name, home address, title and percentage of ownership of every person who is an owner of the bidder. You must also set forth the business form of the bidder.

II. Principals:

	NAME	HOME ADDRESS	TITLE	% OF OWNERSHIP
1.				
2.				
3.				
4.				

If one or more of the owners of the Bidder is itself a corporation, limited liability company or partnership, then for that corporation, limited liability company or partnership owner you must set forth the name, home address, title and percentage of ownership of every person who is an owner of that corporation, limited liability company or partnership.

	NAME	HOME ADDRESS	TITLE	% OF OWNERSHIP
1.				
2.				
3.				
4.				

Bidder's Name _____

SUBCONTRACTOR IDENTIFICATION STATEMENT

LIST OF SUBCONTRACTORS

This form is ONLY required for plumbing and gas fitting, steam and hot water heating and ventilating apparatus, steam power plants, electrical work, structural steel, ornamental iron work, and any other trades required to be identified by the specifications (including, but not limited, to satisfying any DPMC Classification requirements).

CHECK THIS BOX IF NONE OF THE ABOVE LISTED TRADES OR THOSE REQUIRED TO BE IDENTIFIED IN THE SPECIFICATIONS ARE TO BE USED TO PERFORM THE WORK

In compliance with N.J.S.A. 40A:11-16 and the bid specifications, the undersigned hereby lists the name or names of the following subcontractors:

Company Name: _____

Address: _____

Telephone: _____ Subcontract Amount: \$ _____

Specific Scope of Work Subcontracted: _____

License No. _____

Company Name: _____

Address: _____

Telephone: _____ Subcontract Amount: \$ _____

Specific Scope of Work Subcontracted: _____

License No. _____

Company Name: _____

Address: _____

Telephone: _____ Subcontract Amount: \$ _____

Specific Scope of Work Subcontracted: _____

License No. _____

IF MORE THAN THREE SUBCONTRACTORS, PLEASE COPY THIS SHEET AS NECESSARY AND ATTACH TO THE BID PACKAGE.

(Continued on following page)

Bidder's Name _____

SUBCONTRACTOR IDENTIFICATION CERTIFICATION

Note the law does not permit the listing of alternate subcontractors. However, multiple subcontractors for the same trade are permitted to be named provided the bidder meets the following requirements:

- Bidder identifies each subcontractor named for that category;
- Bidder states the scope of work, goods and services (the portion of the work) to be performed by each subcontractor; and
- Bidder provides the price quote provided by each subcontractor.

The bidder is advised that any change of subcontractor(s) from ones listed herein is subject to the County's approval. Change of subcontractor(s) will be approved only if made for good cause and not as a result of an arbitrary purpose.

The undersigned Bidder certifies and declares that the subcontractors listed above shall be used as subcontractors to complete certain portions of the work in this project as set forth in N.J.S.A. 40A: 11-16.

Witness

Date _____

NAME OF BIDDER

ADDRESS

By: _____
ORIGINAL SIGNATURE ONLY

PRINT NAME AND TITLE

Bidder's Name: _____

ACKNOWLEDGMENT OF ADDENDUM

COUNTY OF UNION

(Name of Construction /Public Works Project)

(Project or Bid Number)

Pursuant to N.J.S.A. 40A:11-23.1a., the undersigned bidder, hereby acknowledges receipt of the following notices, revisions, or addenda to the bid advertisement, specifications or bid documents. By indicating date of receipt, bidder acknowledges the submitted bid takes into account the provisions of the notice, revision or addendum. Note that the County of Union's record of notice to bidders shall take precedence and that failure to include provisions of changes in a bid proposal may be subject for rejection of the bid.

Local Unit Reference Number or Title of Addendum/Revision	How Received (mail, fax, pick- up, etc.)	Date Received

ACKNOWLEDGMENT BY BIDDER:

NAME OF BIDDER: _____

ORIGINAL SIGNATURE: _____

PRINTED NAME AND TITLE: _____

DATE: _____

CONTRACTOR BUSINESS REGISTRATION CERTIFICATE

New Mandatory Requirement - Effective 1/18/2010

The recently enacted **P.L. 2009, c.315**, requires that effective January 18, 2010; a contracting agency must receive proof of the bidder's business registration prior to the award of a contract. However, the proof must show that the bidder was in fact registered with the State of New Jersey Department of the Treasury, Division of Revenue and obtained the business registration prior to the receipt of bids.

If subcontractors are named on the bid, proof of the business registration for each subcontractor must be provided prior to the award of bid. Similarly to the bidder, the proof must show that each subcontractor was registered with the State of New Jersey Department of the Treasury, Division of Revenue and obtained the business registration prior to the receipt of bids.

Proof of business registration shall be

- A copy of a Business Registration Certificate issued by the Department of the Treasury, Division of Revenue; or
- A copy of the web version provided by the NJ Division of Revenue, or

Register online at www.nj.gov/treasury/revenue/taxreg.htm. Click the "online" link and then select "Register for Tax and Employer Purposes or call the Division at 609-292-1730.

Note: A NJ Certificate of Authority is not acceptable.

FAILURE to submit proof of registration of the bidder or any subcontractor named on the bid prior to the award of a contract shall be cause to reject the bids.

FAILURE of the bidder or any subcontractor named on the bid to be registered prior to the receipt of bids is cause for a **MANDATORY REJECTION** of bids. (A NON-WAIVABLE DEFECT). This covers construction work as well as non-construction bids.

IN ADDITION:

The contractor shall provide written notice to all **subcontractors and suppliers** not specifically named on the bid of the responsibility to register and submit proof of business registration to the contractor. The requirement of proof of business registration extends down through all levels (tiers) of the project.

Before final payment on the contract is made by the contracting agency, the contractor shall submit an accurate list and the proof of business registration of each subcontractor or supplier used in the fulfillment of the contract, or shall attest that no subcontractors were used.

For the term of the contract, the contractor and each of its affiliates and a subcontractor and each of its affiliates [N.J.S.A. 52:32-44(g)(3)] shall collect and remit to the Director, New Jersey Division of Taxation, the use tax due pursuant to the Sales and Use Tax Act on all sales of tangible personal property delivered into this State, regardless of whether the tangible personal property is intended for a contract with a contracting agency.

A business organization that fails to provide a copy of a business registration as required pursuant to section 1 of P.L.2001,c.134 (C.52:32-44 et al.) or subsection e. or f. of section 92 of P.L.1977,c.110 (C.5:12-92), or that provides false business registration information under the requirements of either of those sections, shall be liable for a penalty of \$25 for each day of violation, not to exceed \$50,000 for each business registration copy not properly provided under a contract with a contracting agency.

Bidder's Name _____

BUSINESS REGISTRATION
Mandatory Requirement

P.L. 2009, c.315, requires that effective January 18, 2010; a contracting agency must receive proof of the bidder's business registration prior to the award of a contract. However, the proof must show that the bidder was in fact registered with the State of New Jersey Department of the Treasury, Division of Revenue and obtained the business registration prior to the receipt of bids.

If subcontractors are named on the bid, proof of the business registration for each must be provided prior to the award of a contract. Similarly to the bidder, the proof must show that each subcontractor was registered with the State of New Jersey Department of the Treasury, Division of Revenue and obtained the business registration prior to the receipt of bids.

Proof of business registration shall be:

- A copy of a Business Registration Certificate issued by the Department of Treasury, Division of Revenue; or
- A copy of the web printed version provided by the NJ Division of Revenue

STATE OF NEW JERSEY
BUSINESS REGISTRATION CERTIFICATE
FOR STATE AGENCY AND CASINO SERVICE CONTRACTORS

DEPARTMENT OF TREASURY
DIVISION OF REVENUE
10000202
TRENTON, N.J. 08646

Taxpayer Name: TAX REG TEST ACCOUNT
Trade Name:
Address: 847 ROEBLING AVE
TRENTON, NJ 08611
Certificate Number: 1093907
Date of Issuance: October 14, 2004

For Office Use Only:
20041014112823533

TAXPAYER NAME: TAX REG TEST ACCOUNT
TAX REGISTRATION TEST ACCOUNT
TAXPAYER IDENTIFICATION#: 070-0822000
ADDRESS: 847 ROEBLING AVE
TRENTON NJ 08611
EFFECTIVE DATE: 09/01/04
FORM BRC(06/04)

TRADE NAME: CLIENT REGISTRATION
SEQUENCE NUMBER: 0107200
ISSUANCE DATE: 07/14/04

John S. Eudy
Authorized Signatory

This Certificate is NOT assignable or transferable. It must be conspicuously displayed at above address.

ATTACH BRC HERE

Bidder's Name _____

AFFIRMATIVE ACTION REQUIREMENT

REQUIRED AFFIRMATIVE ACTION EVIDENCE

General Requirements of P.L. 1975, c. 127: You are hereby put on notice that:

CONSTRUCTION CONTRACTS: The successful contractor must submit within three (3) days of the notice of intent to award or the signing of the contract the initial project manning report (A.A.201). This report should be submitted at the time the signed contract is returned to the County of Union. Attention: *Affirmative Action Officer*.

If the successful contract does not submit the initial project manning report (A.A.201) within the three (3) days from the time the signed contract is returned to the County of Union, the County of Union WILL declare the contractor non-responsive and award the contract to the next lowest responsible bidder.

NAME OF BIDDER

ORIGINAL SIGNATURE

PRINT OR TYPE NAME AND TITLE

DATE THIS FORM IS COMPLETED

EXPERIENCE STATEMENT

I hereby certify that my company has performed the following private or public work, which is relevant to this bid. I further certify that my company has never defaulted under any contract. Should you not sign this form due to prior defaults, please provide details on an attached sheet.

Witness

Date

NAME OF BIDDER

ADDRESS

By: _____
ORIGINAL SIGNATURE ONLY

PRINT NAME AND TITLE

YOU MAY ATTACH ADDITIONAL SHEETS, BUT YOU MUST SIGN AND WITNESS THIS SHEET.

Bidder's Name _____

NON-COLLUSION AFFIDAVIT

(N.J.S.A. 52:34-15)

STATE OF _____)
)
COUNTY OF _____) **SS:** _____

I _____, of the City of _____, in the County of _____, and the State of _____, of full age, being duly sworn according to law, on my oath depose and say that: I am _____ of the firm of _____, the bidder making the proposal for the above named project, and that I executed the said proposal for the above named project, and that I executed the said proposal with full authority to do so; that said bidder has not, directly or indirectly, entered into any agreement, participation in any collusion, or otherwise taken any action in restraint of free, competitive bidding in connection with the above named project; and that all statements contained in said proposal and in this Affidavit are true and correct, and made with full knowledge that the COUNTY OF UNION, NEW JERSEY relies upon the truth of the statements contained in said proposal and in the statements contained in the affidavit in awarding the contract for the said project.

I further warrant that no person or selling agency has been employed or retained to solicit or secure such contract upon an agreement or understanding for a commission, percentage, brokerage or contingent fee, except bona fide employees or bonafide established commercial or selling agencies maintained by _____ (N.J.S.A. 52:34-15).

NAME OF BIDDER

ORIGINAL SIGNATURE ONLY

NOTE: The person who signed the bidder signature page for the bidder should sign this form also.

Subscribed and sworn before me
this ____ day of _____, 200____.

Notary Public of the State of _____
My commission expires: _____

WARNING: IF YOU FAIL TO FULLY, ACCURATELY, AND COMPLETELY FILL OUT THIS AFFIDAVIT OF NON-COLLUSION, YOUR BID MAY BE REJECTED.

Contractor Registration Advisement
For Public Works Projects

A new law, known as "The Public Works Contractor Registration Act" (P.L. 1999, c.238), became effective April 11, 2000. Under the Act, no contractor/subcontractor will be permitted to bid on or engage in any contract for public work, as defined in Section 2 of P.L. 1963, c.150 (C:34:11-56.26), unless that contractor/subcontractor is registered with the New Jersey Department of Labor. The Act provides that upon registration with the Department, a public works contractor/subcontractor will be issued a certificate by the Department indicating compliance with the Act's requirements. The registration fee has been set at \$300.00 per year. Upon the effective date of the Act, public bodies will be expected to request production of such a certificate from those bidding on or engaging in public works projects.

It is important to note that the term "contractor," is defined in the, Act as, "a person, partnership, association, joint stock company, trust, corporation or other legal business entity or successor thereof who enters into a contract which is subject to the provision of the "New Jersey Prevailing Wage Act," P.L. 1963, c.150 (C.34:11-56.25, et seq.) for the construction, reconstruction, demolition, alteration, repair or maintenance of a public building regularly open to and used by the general public or a public institution, and includes any subcontractor or lower tier subcontractor as defined herein: except that, for the purposes of the act, no pumping station, treatment plant or other facility associated with utility and environmental construction, reconstruction, demolition, alteration, repair or maintenance shall be regarded as a public building regularly open to and used by the general public or a public institution."

Registration forms, copies of the Act, and other relevant information can be obtained by contacting:

Contractor Registration Unit
New Jersey Department of Labor
Division of Wage & Hour Compliance
PO Box 389
Trenton, New Jersey 08625-0389
Telephone: 609-292-9464
Fax: 609-633-8591
E-mail: contreg@dol.state.nj.us

Bidder's Name _____

AMERICANS WITH DISABILITIES ACT
EQUAL OPPORTUNITY FOR INDIVIDUALS WITH DISABILITIES

The contractor and the County of Union (hereafter "Owner") do hereby agree that the provisions of Title II of the Americans With Disabilities Act of 1990 (the "Act") (42 U.S.C.S12.101 et seq.), which prohibits discrimination on the basis of disability by public entities in all services, programs and activities provided or made available by public entities, and the rules and regulations promulgated pursuant thereto, are made a part of this contract. In providing any aid, benefit, or service on behalf of the Owner pursuant to this contract, the contractor agrees that the performance shall be in strict compliance with the Act. In the event the contractor, its agents, servants, employees, or subcontractors violate or are alleged to have violated the Act during the performance of this contract, the contractor shall defend the Owner in any action or administrative proceeding commenced pursuant to this Act. The contractor shall indemnify, protect, and save harmless the Owner, its agents, servants, and employees from and against any and all suits, claims, losses, demands, or damages of whatever kind or nature arising out of or claimed to arise out of the alleged violation. The contractor shall, at its own expense, appear, defend, and pay any and all charges for legal services and any and all costs and other expenses arising from such action or administrative proceeding or incurred in connection therewith. In any and all complaints brought pursuant to the Owner's grievance procedure, the contractor agrees to abide by any decision of the Owner which is rendered pursuant to said grievance procedure. If any action or administrative proceeding results in an award of damages against the Owner, or if the Owner incurs any expense to cure a violation of the ADA which has been brought pursuant to its grievance procedure, the contractor shall satisfy and discharge the same at its own expense.

The Owner shall, as soon as practicable after a claim has been made against it, give written notice thereof to the contractor along with full and complete particulars of the claim. If any action or administrative proceeding is brought against the Owner or any of its agents, servants, and employees, the Owner shall expeditiously forward or have forwarded to the contractor every demand, complaint, notice, summons, pleading, or process received by the Owner or its representatives.

It is expressly agreed and understood that any approval by the Owner of the services provided by the contractor pursuant to this contract will not relieve the contractor of the obligation to comply with the Act and to defend, indemnify, protect, and save harmless the Owner pursuant to this paragraph.

It is further agreed and understood that the Owner assumes no obligation to indemnify or save harmless the contractor, its agents, servants, employees and subcontractors for any claim which may arise out of their performance of this Agreement. Furthermore, the contractor expressly understands and agrees that the provisions of this indemnification clause shall in no way limit the contractor's obligations assumed in this Agreement, nor shall they be construed to relieve the contractor from any liability, nor preclude the Owner from taking any other actions available to it under any other provisions of this Agreement or otherwise at law.

Name _____ (Please print or type)

Signature _____ Date _____

Bidder's Name _____

CONTRACTOR RESPONSIBILITY CERTIFICATION

STATE OF NEW JERSEY / _____)

Specify, if Other) SS:

COUNTY OF _____)

I, _____, of the (City, Town, Borough, etc.) of _____ State of _____, of full age, being duly sworn according to law on my oath depose and say that:

I am _____ of the firm of _____, the Bidder making the proposal for the following Project ("Contractor"):

_____, and that I executed said proposal with full authority to do so;

With respect to past performance, work history, current qualifications and performance capabilities, I certify the following with respect to the Bidder/General Contractor and all of the subcontractors on this Project, I certify the following:

- a. The firms have all valid, effective licenses, registrations or certificates required by federal, state, county, or local law, including, but not limited to, licenses, registrations, certificates required to: (1) do business in the designated locale; and (2) perform the contract work it seeks to perform. These include, but are not limited to, licenses, registrations or certificates for any type of trade work or specialty work to be self-performed by Bidder and/or subcontractors.
- b. The firms meet the bonding requirements for the contract, as required by applicable law or the specifications and any insurance requirements, as required by applicable law or the specifications, including general liability insurance, workers compensation insurance and unemployment insurance requirements.
- c. The firms have not been debarred by any federal, state or local government agency or authority in the past three (3) years.
- d. The firms have not defaulted on any project in the past three (3) years.
- e. The firms have not had any type of business, contracting or trade license, registration, or other certification suspended or revoked in the past three (3) years.

f. The firms have not been cited and found guilty for a willful violation of federal or state safety laws in the past three (3) years.

g. The firms and/or its owners have not been convicted of any crime relating to the contracting business by a final decision of a court or government agency in the past three (3) years.

h. The firms will pay all craft employees that it employs on the project the current wage rates and benefits as required under applicable Federal or State prevailing wage laws.

i. The firms participates in an Apprenticeship Program that is currently registered with the USDOL, the NJDOL or any state having equal to or higher requirements as either the USDOL or NJDOL apprenticeship programs, for each craft or trade in which it apprentices. The apprenticeship program in which the firm participates shall have graduated at least one (1) enrollee in each of the past three (3) years.

***** Proof of meeting this qualification standard shall be attached to this form. Bidder shall provide proof of meeting this qualification for those subcontractors required to be identified either pursuant to law or the requirements of the specifications.**

The firms shall continue to participate in the applicable apprenticeship programs for the full duration of the contract work.

Name of Bidder/General Contractor

By: _____
(Signature of Authorized Representative)

Subscribed and sworn to before me
this _____ day of _____, 20__.

(Seal) Notary Public of New Jersey/

Specify Other State

My Commission expires _____, 20__.

NOTE: FAILURE TO COMPLETE AND SUBMIT THIS DOCUMENT WITH YOUR PROPOSAL MAY RESULT IN A REJECTION OF YOUR BID.

Bidder's Name _____

AFFIDAVIT OF GENERAL CONTRACTOR & SUBCONTRACTOR

OSHA COMPLIANCE

STATE OF NEW JERSEY / _____)

Specify, if Other) SS:

COUNTY OF _____)

In accordance with Union County Resolution 2014-0408 I, _____
_____, of the (City, Town, Borough, etc.) of _____
_____ State of _____, of full age, being duly sworn according to law on my oath
depose and say that:

- 1) I am _____ of the firm of _____
_____, the Bidder and General Contractor making the Proposal for the above named Project.
- 2) I have executed the said Proposal with full authority to do so.
- 3) Said Bidder/General Contractor and each subcontractor working on the Project have at least one (1) employee who has successfully completed the OSHA 10-hour construction safety and health course.
- 4) If this Project is in excess of \$500,000.00, the Bidder/General Contractor and each subcontractor working on the Project has at least one (1) employee who has successfully completed the OSHA 30-hour construction safety and health course.

Name of Bidder/General Contractor

By: _____
(Signature of Authorized Representative)

AFFIDAVIT OF GENERAL CONTRACTOR & SUBCONTRACTOR

OSHA COMPLIANCE – (Continued)

Subscribed and sworn to before me

this _____ day of _____, 20__.

(Seal) Notary Public of New Jersey/

Specify Other State

My Commission expires _____, 20__.

NOTE: FAILURE TO COMPLETE AND SUBMIT THIS DOCUMENT WITH YOUR PROPOSAL MAY RESULT IN A REJECTION OF YOUR BID.

Bidder's Name _____

STATEMENT OF BIDDER'S QUALIFICATIONS

All questions must be answered and the data given must be clear and comprehensive. This statement must be notarized. Questions may be answered on separate attached sheets. The Bidder may submit any additional information it desires.

1. _____
(Name of Bidder)
2. _____
(Permanent Main Office Address)
3. _____
(When Organized)
4. _____
(If a Corporation, where incorporated)
5. Number of years your organization has been engaged in construction or contracting business under present firm or trade name? _____
6. How many years of experience in construction work has your organization had (a) as a general contractor? And/or (b) As a subcontractor? _____
7. Contracts on hand: (Attach a list or table showing gross amounts of each Contract and the appropriate dates of completion) _____

8. General character of work performed by you. _____

9. Have you ever failed to complete any work awarded to you? _____

10. Have you ever defaulted on a Contract? _____ If so, complete details, including where and why?

Bidder's Name _____

STATEMENT OF BIDDER'S QUALIFICATIONS - (continued)

11. Has any officer or partner of your organization ever failed to complete a construction contract handled in its own name? If so, state name of individual, name of owner, location and type of project, and reason for the failure to complete. _____

12. List your major equipment available for this Contract.

13. Experience in the construction work similar in importance to this Project.

14. Have you had any material adverse changes from the trades as listed in NJ Notice of Classification within last five (5) years? _____. If so, list prior classification.

15. Background and experience of the principal members of your organization, including the officers.

Individual's Name	Present Position or Office	Yrs. of Construction Experience	Magnitude & Type of Work	In What Capacity

Bidder's Name _____

16. Bank Reference. (Name, Address, Phone, Representative) _____
17. Will you, upon request, fill out a detailed financial statement and furnish any other information that may be required by the proper agency? _____
18. The undersigned, hereby authorizes and requests any person, firm or corporation to furnish any information requested by the proper agency in verification of the responses comprising this Statement of Bidder's Qualifications.
17. Bidder's telephone number, fax number and e-mail address (if applicable).
- Phone _____
- Fax _____
- E-mail _____
- Mobile _____

Dated at _____ this _____ day of __, 20__.

BIDDER (Signature)

BIDDER (Print Name)

Subscribed and sworn to before me
this _____ day of _____, 20__.

(Seal) Notary Public of New Jersey/
Specify Other State
My Commission Expires _____, 20__.

**NOTE: FAILURE TO COMPLETE AND SUBMIT THIS DOCUMENT WITH
YOUR PROPOSAL MAY RESULT IN A REJECTION OF YOUR BID.**

Bidder's Name _____

CONTRACTOR PERFORMANCE RECORD

List all contracts completed by you below or provide separate form.

Name of Owner	Name & Location of Project: Type Of Work	Prime or Sub-Cont.	Engineer or Architect in Charge for Owner	Contract Price (Omit Cost)	Date Completed	Was Time* Extension Necessary	Were Any Penalties Imposed	Were Liens* Claims or Stop Notice Filed

* If answer is YES, provide explanation of details in connection with non-completion of contracts, time extensions, penalties imposed, labor troubles, liens, claims and notices filed against contracts listed in preceding item "Performance Record" on an attached sheet.

NOTE: FAILURE TO COMPLETE AND SUBMIT THIS DOCUMENT WITH YOUR PROPOSAL MAY RESULT IN A REJECTION OF YOUR BID.

Bidder's Name _____

CONTRACTOR PERFORMANCE RECORD
CERTIFICATION

The information above is true and complete to the best of my knowledge and belief.

(Name of Organization)

(Signature)

(Title)

Subscribed and sworn to before me

this _____ day of _____, 20__.

(Seal) Notary Public of New Jersey/
Specify Other State

My Commission Expires _____, 20__.

PRIOR NEGATIVE EXPERIENCE QUESTIONNAIRE

(N.J.S.A. 40A:11-4)

1. Within the past ten (10) years, have you been found, through either court adjudication, arbitration, mediation, or other contractually stipulated alternate dispute resolution mechanism, to have: failed to provide or perform goods or services; or failed to complete a contract in a timely manner; or otherwise performed unsatisfactorily under a prior contract with a public entity?

_____ yes _____ no If yes, please provide full, detailed explanation.

2. Within the past ten (10) years, have you defaulted on a contract, thereby requiring a public entity to utilize the services of another contractor to provide the goods or perform the services or to correct or complete the contract?

_____ yes _____ no If yes, please provide full, detailed explanation.

3. Within the past ten (10) years, have you defaulted on a contract, thereby requiring a public entity to look to your surety for completion of the contract or tender of the costs of completion?

_____ yes _____ no If yes, please provide full, detailed explanation.

4. Within the past ten (10) years, have you been debarred or suspended from contracting with any of the agencies or department of the executive branch of the State of New Jersey at the time of the contract award, where the action was based on failure to perform a contract for goods or services with a public entity?

_____ yes _____ no If yes, please provide full, detailed explanation.

Bidder's Name _____

PRIOR NEGATIVE EXPERIENCE CERTIFICATION

I hereby certify that the above statements are true and accurate as of this _____
day of _____, 20__.

Name of Contractor

By _____
(Signature of Authorized Representative)

Subscribed and sworn to before me
this _____ day of _____, 20__.

(Seal) Notary Public of New Jersey/
Specify Other State

My Commission Expires _____, 20__.

NOTE: FAILURE TO COMPLETE AND SUBMIT THIS DOCUMENT WITH YOUR PROPOSAL MAY RESULT IN A REJECTION OF YOUR BID.

Bidder's Name _____

TO BE COMPLETED ONLY WHEN FINAL PAYMENT IS REQUESTED

CONTRACTOR'S CERTIFICATION OF COMPLIANCE - NEW JERSEY PREVAILING WAGE ACT

TO: County of Union
Division of Engineering
2325 South Avenue
Scotch Plains, New Jersey 07076

CONTRACT:

PROJECT:

In accordance with the requirements of the New Jersey Prevailing Wage Act, N.J.S.A. 34:11-56 et al *, the undersigned contractor on the public work being performed for:

COUNTY OF UNION

hereby certifies that he/she has complied with the contract requirements regarding the payment of the minimum prevailing wages established under "The New Jersey Prevailing Wage Act" N.J.S.A. 34:11-56 et al.

CONTRACTOR: _____
ADDRESS: _____

BY: _____

ORIGINAL SIGNATURE ONLY

STATE OF NEW JERSEY
COUNTY OF _____

Being by me duly sworn according to law, on his oath deposes and says that _____ is _____ of _____ the above named contractor, and that the facts set forth in the above statement are true.

Subscribed and sworn before me
this ____ day of _____, 200__.

Notary Public: _____
My Commission Expires: _____

* N.J.S.A. 34:11-56.33 requires the contractor and subcontractor to file written statements with the public body in form satisfactory to the Commissioner certifying to the amounts then due and owing from such contractor and subcontractor filing such statement to any and all workmen for wages due on account of the public work, setting forth therein the names of the persons whose wages are unpaid and the amount due to each respectively. Union County will withhold the amount so deducted for the benefit of the workmen whose wages are unpaid as shown by the verified statement filed, and will pay directly to any workman the amount shown by such statement to be due to him for such wages. Such payment shall thereby discharge the obligation of the contractor to the person receiving such payment to the extent of the amount thereof.

Bidder's Name _____

UNCOMPLETED CONTRACTS AFFIDAVIT
(To be Submitted with DPMC Form 701)

PURSUANT TO N.J.A.C. 17:19-2.13, BIDDER DECLARES THE FOLLOWING WITH RESPECT TO ITS UNCOMPLETED CONTRACTS, ON ALL WORK, FROM WHATEVER SOURCE (PUBLIC AND PRIVATE), BOTH IN NEW JERSEY AND FROM OTHER GOVERNMENTAL JURISDICTIONS

ENTITY	PROJECT TITLE	ORIGINAL CONTRACT AMOUNT	UNCOMPLETED AMOUNT AS OF BID OPENING DATE	NAME AND TELEPHONE NUMBER OF PARTY TO BE CONTACTED FROM ENTITY FOR VERIFICATION

TOTAL AMOUNT OF UNCOMPLETED CONTRACTS \$ _____

Sworn and Subscribed to Before me

This _____ day of _____, 20____

Notary Public

BIDDER:

(Signature)

(Print Name)

NOTE: FAILURE TO COMPLETE AND SUBMIT THIS DOCUMENT WITH YOUR PROPOSAL MAY RESULT IN A REJECTION OF YOUR BID.

Bidder's Name _____

CERTIFICATE OF INSURANCE STATEMENT

The Bidder fully understands the County of Union insurance requirements as stated in the Instructions to Bidders as well as the Owner/Contractor Agreement and agrees to provide all insurance required by these documents prior to the issuance of the Notice to Proceed.

BIDDER (Signature)

BIDDER (Print Name)

NOTE: FAILURE TO COMPLETE AND SUBMIT THIS DOCUMENT WITH YOUR PROPOSAL MAY RESULT IN A REJECTION OF YOUR BID.

Bidder's Name _____

COLLECTION OF USE TAX ON SALES TO LOCAL GOVERNMENTS STATEMENT

The Bidder fully understands the requirements of the use tax on sales to local governments as stated in the General Conditions to the Contract for Construction and the Instructions to Bidders, and agrees at all times to comply with the "Contractor Use Tax Collection Legislation", as defined therein, and the terms relating thereto contained in the Contract Documents.

BIDDER (Signature)

BIDDER (Print Name)

NOTE: FAILURE TO COMPLETE AND SUBMIT THIS DOCUMENT WITH YOUR PROPOSAL MAY RESULT IN A REJECTION OF YOUR BID.

Bidder's Name _____

TIME OF COMPLETION

The undersigned proposed that if awarded the Contract, the scope of work will be started within ten (10) calendar days and will be substantially completed within **Sixty (60) calendar days** from the date of the notice to proceed.

I, _____ of _____
NAME (Print or type) COMPANY

Agree to complete work in the time frame specified _____
SIGNATURE

SITE VISIT – GENERAL CONTRACTOR

I, _____ of _____
NAME (Print or type) COMPANY

Visited the site of the work on _____
SIGNATURE

**COUNTY OF UNION NEW JERSEY
Division of Purchasing**

DISCLOSURE OF INVESTMENT ACTIVITIES IN IRAN

Solicitation Number: _____ Bidder/Offeror: _____

Pursuant to Public law 2012, c. 25, any person or entity that submits a bid or proposal or otherwise proposes to enter into or renew a contract must complete the certification below to attest, under penalty of perjury, that the person or entity, or one of the person or entity's parents, subsidiaries, or affiliates, is not identified on a list created and maintained by the Department of the Treasury as a person or entity engaging in investment activities in Iran. If the Director finds a person or entity to be in violation of the principles which are the subject of the law, s/he shall take action as may be appropriate and provided by law, rule or contract, including but not limited to, imposing sanctions, seeking compliance, recovering damages, declaring the party in default and seeking debarment or suspension of the person or entity.

I certify, pursuant to Public Law 2012, c. 25, that the person or entity listed above for which I am authorized to bid/renew:

is not providing goods or services of \$20,000,000 or more in the energy sector of Iran, including a person or entity that provides oil or liquefied natural gas tankers, or products used to construct or maintain pipe lines used to transport oil or liquefied natural gas, for the energy sector of Iran,
AND

is not a financial institution that extends \$20,000,000 or more in credit to another person or entity, for 45 days or more, if that person or entity will use the credit to provide goods or services in the energy sector in Iran.

In the event that a person or entity is unable to make the above certification because it or one of its parents, subsidiaries, or affiliates has engaged in the above-referenced activities, a detailed, accurate and precise description of the activities must be provided in part 2 below to the Division of Purchase under penalty of perjury. Failure to provide such will result in the proposal being rendered as non-responsive and appropriate penalties, fines and/or sanctions will be assessed as provided by law.

PART 2: PLEASE PROVIDE FURTHER INFORMATION RELATED TO INVESTMENT ACTIVITIES IN IRAN. You must provide, accurate and precise description of the activities of the bidding person/entity, or one of its parents, subsidiaries or affiliates, engaging in the investment activities in Iran outlined above by completing the boxes below.

Name _____ Relationship to Bidder/Offeror _____

Description of Activities _____

Duration of Engagement _____ Anticipated Cessation Date _____

DISCLOSURE OF INVESTMENT ACTIVITIES IN IRAN – (Continued)

Bidder/Offeror
Contact Name _____ Contact Phone Number _____

Certification: I, being duly sworn upon my oath, hereby represent and state that the foregoing information and any attachments thereto to the best of my knowledge are true and complete. I attest that I am authorized to execute this certification on behalf of the above referenced person or entity. I acknowledge that Union County is relying on the information contained herein and hereby acknowledge that I am under a continuing obligation from the date of this certification through the completion of any contracts with the County to notify the County in writing of any changes to the answers of information contained herein. I acknowledge that I am aware that it is a criminal offense to make a false statement or misrepresentation in this certification, and if I do so, I recognize that I am subject to criminal prosecution under the law and that it will also constitute a material breach of my agreement(s) with Union County, New Jersey and that the County at its option may declare any contract(s) resulting from this certification void and unenforceable.

Full Name (Print) _____ Signature _____

Title _____ Date _____

STANDARD SPECIFICATIONS

The Standard Specifications for Road and Bridge Construction of New Jersey Department of Transportation, 2007 Edition; is added to and/or amended elsewhere herein by the Notice to Contractors (Advertisement), Proposal, Information for Bidders, General Conditions, Special Provisions, Project Plans, and Supplementary Specifications; shall, insofar as technical requirements are involved, govern in the execution of this project.

Such Standard Specifications are made a part of these Specifications by this reference and will not be repeated herein. It is the responsibility of prospective bidders to familiarize themselves with these Standard Specifications, copies of which may be examined at the office of the Engineer and may be obtained, upon payment of the cost thereof, from:

Department of Transportation
State of New Jersey
1035 Parkway Avenue
Trenton, New Jersey 08625

The Notice to Bidders (Advertisement), Proposal, General Conditions, Instructions to Bidders, Special Provisions, Project Plans and/or Technical Specifications shall govern and prevail in the case of conflict between them and the Standard Specifications.

In these Standard Specifications the words "COMMISSIONER" or "DEPARTMENT" shall refer to and mean the person, persons, body, board or agent legally empowered to enter into contracts and otherwise legally act for the Owner. The words "RESIDENT ENGINEER (RE)", "ENGINEER" or "STATE" shall refer to and mean the professional engineering representative of the Owner as hereinbefore defined and the word "INSPECTOR" shall mean the authorized project representative of the Engineer with the authority as hereinbefore defined. The word "LABORATORY" shall mean and refer to the Engineer who may, at his discretion, and with the consent of the Owner, employ qualified technical personnel or testing laboratories to assist him in fulfilling the duties normally assigned to the "LABORATORY" in these Standard Specifications.

When reference is made herein to the bulletins, standards, specifications, publications or requirements of the Manual on Uniform Traffic Control Devices (MUTCD), Institute of Traffic Engineers (ITE), Federal Highway Administration (FHWA), American Association of State Highway Officials (AASHTO), the American Concrete Institute (ACI), the American Society of Civil Engineers (ASCE) or similar national or regional societies, associations, institutes or organizations; the requirements of the bulletins, specifications, publications or requirements referred to shall be considered a part of these Specifications by such reference and shall not be repeated herein but shall have the same import and be as binding as if herein set forth in full.

DRAFT AIA Document A101™ - 2007

Standard Form of Agreement Between Owner and Contractor where the basis of payment is a Stipulated Sum

AGREEMENT made as of the day of in the year
(In words, indicate day, month and year.)

BETWEEN the Owner:
(Name, legal status, address and other information)

and the Contractor:
(Name, legal status, address and other information)

for the following Project:
(Name, location and detailed description)

The County Engineer or his designee:
(Name, legal status, address and other information)

The Owner and Contractor agree as follows.



ADDITIONS AND DELETIONS:
The author of this document has added information needed for its completion. The author may also have revised the text of the original AIA standard form. An Additions and Deletions Report that notes added information as well as revisions to the standard form text is available from the author and should be reviewed.

This document has important legal consequences. Consultation with an attorney is encouraged with respect to its completion or modification.

AIA Document A201™-2007, General Conditions of the Contract for Construction, is adopted in this document by reference. Do not use with other general conditions unless this document is modified.

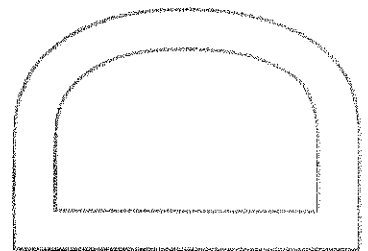
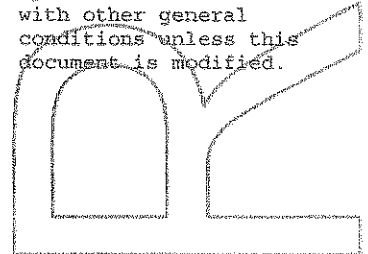

ELECTRONIC COPYING of any portion of this AIA Document to another electronic file is prohibited and constitutes a violation of copyright laws as set forth in the footer of this document.

TABLE OF ARTICLES

- 1 THE CONTRACT DOCUMENTS
- 2 THE WORK OF THIS CONTRACT
- 3 DATE OF COMMENCEMENT AND SUBSTANTIAL COMPLETION
- 4 CONTRACT SUM
- 5 PAYMENTS
- 6 DISPUTE RESOLUTION
- 7 TERMINATION OR SUSPENSION
- 8 MISCELLANEOUS PROVISIONS
- 9 ENUMERATION OF CONTRACT DOCUMENTS
- 10 INSURANCE AND BONDS

ARTICLE 1 THE CONTRACT DOCUMENTS

The Contract Documents consist of this Agreement, Conditions of the Contract (General, Supplementary and other Conditions), Drawings, Specifications, Addenda issued prior to execution of this Agreement, other documents listed in this Agreement and Modifications issued after execution of this Agreement, all of which form the Contract, and are as fully a part of the Contract as if attached to this Agreement or repeated herein. The Contract represents the entire and integrated agreement between the parties hereto and supersedes prior negotiations, representations or agreements, either written or oral. An enumeration of the Contract Documents, other than a Modification, appears in Article 9.

ARTICLE 2 THE WORK OF THIS CONTRACT

The Contractor shall fully execute the Work described in the Contract Documents, except as specifically indicated in the Contract Documents to be the responsibility of others. The Contractor will not be compensated for labor or materials outside the scope of work that is not properly authorized.

ARTICLE 3 DATE OF COMMENCEMENT AND SUBSTANTIAL COMPLETION

§ 3.1 The date of commencement of the Work shall be the date of this Agreement unless a different date is stated below or provision is made for the date to be fixed in a Notice to proceed issued by the Owner, which is anticipated to be on or about

()

If, prior to the commencement of the Work, the Owner requires time to file mortgages and other security interests, the Owner's time requirement shall be as follows: Not applicable.

()

§ 3.2 The Contract Time shall be measured from the date of commencement.

§ 3.3 The Contractor shall achieve Substantial Completion of the entire Work not later than () days from the date of commencement, or as follows:

(Insert number of calendar days. Alternatively, a calendar date may be used when coordinated with the date of commencement. If appropriate, insert requirements for earlier Substantial Completion of certain portions of the Work.)

Portion of Work

Substantial Completion Date

Entire Work

TBD

, subject to adjustments of this Contract Time as provided in the Contract Documents.
(Insert provisions, if any, for liquidated damages relating to failure to achieve Substantial Completion on time or for bonus payments for early completion of the Work.)

« » Should the Contractor fail to complete fully, and in conformity with all provisions of the Contract within the Contract Time, the Contractor shall, and hereby agrees to pay the Owner One Thousand Dollars (\$1,000.00) per day for as liquidated damages, for each consecutive calendar day beyond the number of days allowed by the Contract, which sum is agreed upon as reasonable and proper measure of damages that the Owner will sustain per diem by failure of Contractor to complete Work within time as stipulated; it is being recognized by Owner and Contractor that the injury to Owner that could result from a failure of the Contractor to complete on schedule, is uncertain and cannot be computed exactly. In no way shall costs of Liquidated Damages to be construed as a penalty to the Contractor. (See Bid Documents)

ARTICLE 4 CONTRACT SUM

§ 4.1 The Owner shall pay the Contractor the Contract Sum in current funds for the Contractor's performance of the Contract. The Contract Sum shall be « » (\$ « »), subject to additions and deductions as provided in the Contract Documents.

§ 4.2 The Contract Sum is based upon the following alternates, if any, which are described in the Contract Documents and are hereby accepted by the Owner:
(State the numbers or other identification of accepted alternates. If the bidding or proposal documents permit the Owner to accept other alternates subsequent to the execution of this Agreement, attach a schedule of such other alternates showing the amount for each and the date when that amount expires.)

§ 4.3 Unit prices, if any:
(Identify and state the unit price; state quantity limitations, if any, to which the unit price will be applicable.)

Item	Units and Limitations	Price Per Unit (\$0.00)
« »	« »	« »

§ 4.4 Allowances included in the Contract Sum, if any:
(Identify allowance and state exclusions, if any, from the allowance price.)

Item	Price
« »	« »

ARTICLE 5 PAYMENTS

§ 5.1 PROGRESS PAYMENTS

§ 5.1.1 Based upon Applications for Payment submitted to the County Engineer or his designee by the Contractor and Certificates for Payment issued by the County Engineer or his designee, the Owner shall make progress payments on account of the Contract Sum to the Contractor as provided below and elsewhere in the Contract Documents.

§ 5.1.2 The period covered by each Application for Payment shall be one calendar month ending on the last day of the month, or as follows:

§ 5.1.3 The Contractor shall submit a Preliminary Payment Request (Pencil Requisition) to the County Engineer or his designee on the twenty-fifth (25th) day of any given calendar month for Work performed during that month,

Upon receipt of the Pencil Requisition from the Contractor, the County Engineer or his designee shall review the Pencil Requisition and approve or disapprove of it in whole or in part as set forth hereafter. Within (4) calendar days of receipt of the Pencil Requisition from the Contractor, the County Engineer or his designee shall return the Pencil Requisition to the Contractor, with those charges that are approved or disapproved, if any, by the County Engineer or his designee, for the Contractor's incorporation into an Application for Payment. Within two (2) calendar days of return of the Pencil Requisition from the County Engineer or his designee, the Contractor shall submit a formal application for Payment to the County Engineer or his designee for review and approval by the County Engineer or his designee incorporating any revisions made by the County Engineer or his designee in the Pencil Requisition submission. Within five (5) calendar days of receipt of Contractor's Application for Payment, the County Engineer or his designee shall take any one of the following actions:

- 1) Certify the entire Application for Payment;
- 2) Certify partial payment and provide the Contractor with reasons for withholding the remaining portion of the payment; or
- 3) Withhold certification of the entire Application for Payment and provide the Contractor with reasons for withholding the entire payment,

Once the Application for Payment is certified either in whole or in part, the County Engineer or his designee shall transmit the Certified Payment Application within three (3) calendar days to the Owner for its review and payment. The Owner shall make payment to the Contractor for the Certified Payment Amount by no later than the time period set forth in the New Jersey Prompt Payment Act following receipt of the Certificate for Payment from the County Engineer or his designee. The Owner shall not be obligated to pay any Application for Payment until the Application for Payment is certified by the County Engineer or his designee. Approval of any Application for Payment may be withheld should the Contractor fail to submit Manning Reports in a timely manner.

Pursuant to N.J.S.A. 2A:30A-1 et seq. (the "Prompt Payment Act"), a public or governmental entity that requires the entity's governing body to vote on authorizations for each periodic payment, final payment, or retainage monies, such as the Owner, is excepted from the timing requirements of the Act. Accordingly, the Owner shall not approve the Contractor's Application for Payment until it is certified by the County Engineer or his designee in accordance herewith and shall not approve the Contractor's Certified Payment Application until the next scheduled public meeting of the Owner following the Owner's receipt of the Certified Payment Application from the County Engineer or his designee. The Owner shall not make payment to the Contractor for the Certified Payment Amount until the Owner's subsequent payment cycle following its approval of the Payment Application.

Pursuant to this same Act, if a payment due pursuant to the provisions herein is not made in a timely manner, the Owner shall be liable for the amount of money owed under the contract, plus interest at a rate equal to the prime rate plus one percent (1%), notwithstanding anything to the contrary in the Contract Documents. Interest on amounts due pursuant to the Act shall be paid to the prime contractor for the period beginning on the day after the required payment date and ending on the day on which the check for payment is received by the Contractor.

Pursuant to this same Act, disputes regarding whether a party has failed to make payments required by the Act may be submitted to a process of alternative dispute resolution, notwithstanding anything to the contrary in the contract documents, where the parties agree to same. Alternative dispute resolution permitted by the Act shall not apply to disputes concerning any other matters that may arise under or from this Contract. Any civil action brought to collect payments shall be conducted in Union County, State of New Jersey, and the prevailing party shall be awarded reasonable costs and attorneys' fees.

§5.1.4 The County Engineer or his designee may decide not to certify payment and may withhold a Certificate for Payment, in whole or in part, to the extent reasonably necessary to protect the Owner if, in the County Engineer or his designee's opinion, the representations as described in Section 5.1.5 below cannot be made to the Owner. If the County Engineer or his designee withholds a Certificate for Payment, the County Engineer or his designee will notify the Contractor and Owner as provided in Section 5.1.3 above. If the Contractor and County Engineer or his designee cannot agree on a revised amount, the County Engineer or his designee will issue a Certificate for Payment for the amount for which the County Engineer or his designee is able to make such representations to the Owner as set forth in Section 5.1.3 above. The County Engineer or his designee may also decide to withhold certifying

payment in whole or in part, or, because of subsequently discovered evidence or subsequent observations, to such extent as may be necessary in the County Engineer or his designee's opinion to protect the Owner from loss because of:

- .1 Defective Work not remedied;
- .2 third party claims filed or reasonable evidence indicating probable filing of such claims;
- .3 failure of the Contractor to make payments properly to Subcontractors or for labor, materials, or equipment;
- .4 reasonable evidence that the Work cannot be completed for the unpaid balance of the Contract Sum;
- .5 damage to the Owner or another contractor;
- .6 reasonable evidence that the Work will not be completed within the Contract Time, and that the unpaid balance would not be adequate to cover actual or Liquidated Damages for the anticipated delay;
- .7 failure to carry out the Work in accordance with the Contract Documents;
- .8 avoidable delay in the progress of the Work;
- .9 deliberate delay in the submission for approval of names of Subcontractors, materialmen, sources of supply, shop drawings, and samples;
- .10 failure to maintain the Project Site in a safe and satisfactory condition in accordance with good construction practices as determined by the County Engineer or his designee; or
- .11 failure to submit updates as required by the General Conditions.

When the foregoing reasons for withholding certification are resolved, certification will be made for amounts previously withheld in the manner set forth in Section 5.1.3 above.

§5.1.5 The issuance of a separate Certificate for Payment will constitute representations made separately by the County Engineer or his designee to the Owner, based on its individual observations at the site and the data comprising the Application for Payment submitted by the Contractor, that the Work has progressed to the point indicated and that, to the best of the County Engineer or his designee's knowledge, information and belief, quality of the Work is in accordance with the Contract Documents.

The foregoing representations are subject to an evaluation of the Work for conformance with the Contract Documents upon Substantial Completion, to results of subsequent tests and inspections, to minor deviations from the Contract Documents correctable prior to completion and to specific qualifications expressed by the County Engineer or his designee. The

issuance of a separate Certificate of Payment will further constitute a representation that the Contractor is entitled to payment in the amount certified. However, the issuance of a separate Certificate for Payment will not be a representation that the County Engineer or his designees has (1) made exhaustive or continuous on-site inspections to check the quality or quantity of the Work; (2) reviewed the Contractor's construction means, methods, techniques, sequences or procedures; (3) reviewed copies of requisitions received from Subcontractor's and materials suppliers and other data requested by the Owner to substantiate the Contractor's right to payment; or (4) made examination to ascertain how or for what purpose the Contractor has used money previously paid on account of the Contract Sum.

§5.1.6 Each Application for Payment shall be based on the most recent schedule of values submitted by the Contractor in accordance with the Contract Documents. The schedule of values shall allocate the entire Contract Sum among the various portions of the Work. The schedule of values shall be prepared in such form and supported by such data to substantiate its accuracy as the County Engineer or his designee may require. This schedule, unless objected to by the County Engineer or his designee, shall be used as a basis for reviewing the Contractor's Applications for Payment.

§5.1.7 Applications for Payment shall show the percentage of completion of each portion of the Work as of the end of the period covered by the Application for Payment.

§ 5.1.8 Subject to other provisions of the Contract Documents, the amount of each progress payment shall be computed as follows:

- .1 Take that portion of the Contract Sum properly allocable to completed Work as determined by multiplying the percentage completion of each portion of the Work by the share of the Contract Sum allocated to that portion of the Work in the schedule of values, less retainage of percent (%). Pending final determination of cost to the Owner of changes in the Work, amounts not in dispute shall be included as provided in Section 7.3.9 of AIA Document A201™-2007, General Conditions of the Contract for Construction;
- .2 Add that portion of the Contract Sum properly allocable to materials and equipment delivered and suitably stored at the site for subsequent incorporation in the completed construction (or, if approved in advance by the Owner, suitably stored off the site at a location agreed upon in writing), less retainage of percent (%);
- .3 Subtract the aggregate of previous payments made by the Owner; and
- .4 Subtract amounts, if any, for which the County Engineer or his designee has withheld or nullified a Certificate for Payment as provided in Section 9.5 of AIA Document A201-2007.

§5.1.9 The progress payment amount determined in accordance with Section 5.1.8 shall be further modified under the following circumstances:

- .1 Add, upon Substantial Completion of the Work, a sum sufficient to increase the total payments to the full amount of the Contract Sum, less such amounts as the County Engineer or his designee shall determine for incomplete Work, retainage applicable to such work and unsettled claims; and
- .2 Add, if final completion of the Work is thereafter materially delayed through no fault of the Contractor, any additional amounts payable in accordance with Section 9.10.3 of AIA Document A201-2007.

§5.1.10 Retainage shall be determined as follows: Pursuant to N.J.S.A. 40A:11-6.1, the Owner will withhold two percent (2%) of the amount due on each partial payment when the outstanding balance of the Contract exceeds One Hundred Thousand Dollars (\$100,000.00).

§5.1.11 Except with the Owner's prior approval, the Contractor shall not make advance payments to suppliers for materials or equipment which have not been delivered and stored at the site.

§ 5.2 FINAL PAYMENT

§ 5.2.1 Final payment, constituting the entire unpaid balance of the Contract Sum, shall be made by the Owner to the Contractor when

- .1 the Contractor has fully performed the Contract except for the Contractor's responsibility to correct Work as provided in Section 12.2.2 of AIA Document A201-2007, and to satisfy other requirements, if any, which extend beyond final payment; and
- .2 a final Certificate for Payment has been issued by the County Engineer or his designee.

§ 5.2.2 The Owner's final payment to the Contractor shall be made no later than 30 days after the issuance of the County Engineer or his designee's final Certificate for Payment, or as follows:

« »

ARTICLE 6 DISPUTE RESOLUTION

§ 6.1 INITIAL DECISION MAKER

The County Engineer or his designee will serve as Initial Decision Maker pursuant to Section 15.2 of AIA Document A201-2007, unless the parties appoint below another individual, not a party to this Agreement, to serve as Initial Decision Maker.

(If the parties mutually agree, insert the name, address and other contact information of the Initial Decision Maker, if other than the County Engineer or his designee.)

« »
« »
« »
« »

§ 6.2 BINDING DISPUTE RESOLUTION

Except as provided in Section 5.1.3 of the Standard Form of Agreement between the Owner and Contractor, all claims, disputes or other matters in question between the parties to this Contract, arising out of or relating to the Project or to the Contract, or the alleged breach hereof, shall be subject one to mediation, and if not resolved, then same shall be decided in a Court of competent jurisdiction venued in Union County, New Jersey. No party may be compelled to submit any dispute concerning the Project to arbitration. In the event any claim arising from the Project is beyond the jurisdiction of the court, the Contract consents to joinder as a party to such action or alternative dispute proceeding.

ARTICLE 7 TERMINATION OR SUSPENSION

§ 7.1 The Contract may be terminated by the Owner or the Contractor as provided in Article 14 of AIA Document A201-2007.

§ 7.2 The Work may be suspended by the Owner as provided in Article 14 of AIA Document A201-2007.

ARTICLE 8 MISCELLANEOUS PROVISIONS

§ 8.1 Where reference is made in this Agreement to a provision of AIA Document A201-2007 or another Contract Document, the reference refers to that provision as amended or supplemented by other provisions of the Contract Documents.

§ 8.2 Payments due and unpaid under the Contract shall in no instance bear interest, except as required by law in accordance with Section 5.1.3 hereof.

§ 8.3 The Contractor shall ensure that the Project Site is maintained in a clean and safe condition at all times, based upon Owner's sole discretion. If the Contractor fails to keep the Project Site in a clean and safe condition, said failure shall result in the following:

- .1 all claims resulting from the Contractor's failure shall be the Contractor's responsibility;
- .2 said failure shall constitute an act of default and a substantial breach of the Contract giving the Owner remedies under the contract Documents; and
- .3 the Owner shall have the right to withhold any payments until the Contractor cures its failure.

Failure to do so shall authorize the Owner to withhold any Applications for payment until such time as the Contractor has rectified same. Further, if the Contractor fails to clean up as provided in the Contract Documents, the Owner may do so and the cost thereof shall be charged to the Contractor.

§ 8.4 Indemnification – See Indemnification Requirements in Bid Documents.

§ 8.5 The within contract shall be governed by and interpreted pursuant to the law of the State of New Jersey.

§ 8.6 The Contractor shall comply with the anti-discrimination provisions of N.J.S.A. 10:2-1 et seq., the New Jersey Law Against Discrimination, N.J.S.A. 10:5-1 et seq., N.J.A.C. 17:27-1.1 et seq. and shall guarantee to afford equal opportunity in performance of the Work in accordance with an affirmative action program approved by the State Treasurer. (See Page G-21).

§ 8.7 The Contractor shall submit proof of Business Registration for itself and its subcontractors to the Owner and shall provide written notice to its subcontractors and suppliers of the responsibility to submit proof of business registration to the contractor. The requirement of proof of Business Registration extends down through all levels (tiers) of the Project.

The Contractor agrees to comply with the rules and regulations promulgated pursuant to the Contractor Use Tax Collection Legislation.

For the term of the contract, the Contractor, any subcontractor, and each of their affiliates [N.J.S.A. 52:32-44(g)93], shall collect and remit to the New Jersey Director of the Division of Taxation in the Department of Treasury, the use tax due pursuant to the "Sales and Use Tax Act," P.L. 1966, c. 30 (C.54:32B-1 et seq.) on all of their sales of tangible personal property delivered into the State of New Jersey, regardless of whether the tangible personal property is intended for a contract with a contracting agency. For purposes herein, "affiliate" shall mean any entity that: (a)

directly, indirectly or constructively controls another entity; (b) is directly, indirectly, or constructively controlled by another entity; or (c) is subject to the control of a common entity. For purposes of the immediately preceding sentence, an entity controls another entity if it owns, directly or indirectly, more than fifty percent (50%) of the Ownership interest in that entity.

§8.8 This Standard Form of Agreement and the General Conditions set forth in the Bid Documents shall control in the case of conflict between these documents and the Project Specifications, the Project Manual, and any other exhibits incorporated by reference in this Contract.

ARTICLE 9 ENUMERATION OF CONTRACT DOCUMENTS

§ 9.1 The Contract Documents, except for Modifications issued after execution of this Agreement, are enumerated in the sections below, and incorporated herein as if set forth in their entirety.

§ 9.1.1 The Agreement is this executed AIA Document A101-2007, Standard Form of Agreement Between Owner and Contractor.

§ 9.1.2 The General Conditions are AIA Document A201-2007, General Conditions of the Contract for Construction.

§ 9.1.3 The Supplementary and other Conditions of the Contract:

Document	Title	Date	Pages

§ 9.1.4 The Specifications:

(Either list the Specifications here or refer to an exhibit attached to this Agreement.)

« See Specifications as referenced by Exhibit B.

Section	Title	Date	Pages

§ 9.1.5 The Drawings:

(Either list the Drawings here or refer to an exhibit attached to this Agreement.)

« See List of Drawings, annexed hereto as Exhibit C.

Number	Title	Date

§ 9.1.6 The Addenda, if any:

Number	Date	Pages

Portions of Addenda relating to bidding requirements are not part of the Contract Documents unless the bidding requirements are also enumerated in this Article 9.

§ 9.1.7 Additional documents, if any, forming part of the Contract Documents:

.1 AIA Document E201™-2007, Digital Data Protocol Exhibit, if completed by the parties, or the following:

■

.2 Other documents, if any, listed below:

■

ARTICLE 10 INSURANCE AND BONDS

The Contractor shall purchase and maintain insurance and provide bonds as set forth in Article 11 of AIA Document A201-2007.

(State bonding requirements, if any, and limits of liability for insurance required in Article 11 of AIA Document A201-2007.)

Type of insurance or bond

Limit of liability or bond amount (\$0.00)

This Agreement entered into as of the day and year first written above.

OWNER (Signature)

<><>

(Printed name and title)

CONTRACTOR (Signature)

<><>

(Printed name and title)

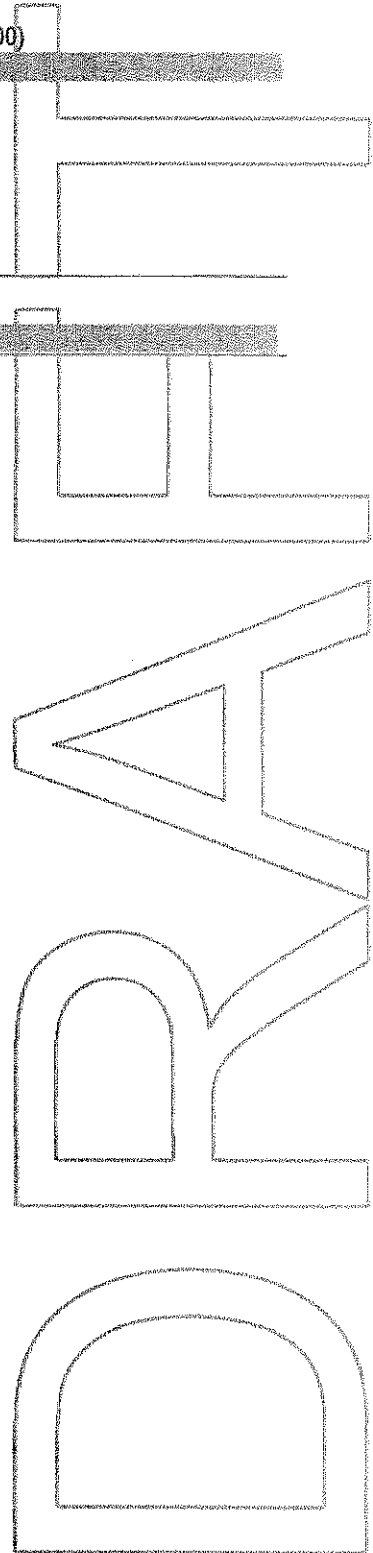

DRAFT AIA Document A201™ - 2007

General Conditions of the Contract for Construction

for the following PROJECT:

(Name and location or address)

«County of Union»

« »

THE OWNER:

(Name, legal status and address)

« »

« »

THE ENGINEER, OR HIS DESIGNEE :

(Name, legal status and address)

« »

« »

TABLE OF ARTICLES

- 1 GENERAL PROVISIONS
- 2 OWNER
- 3 CONTRACTOR
- 4 ENGINEER, OR HIS DESIGNEE :
- 5 SUBCONTRACTORS
- 6 CONSTRUCTION BY OWNER OR BY SEPARATE CONTRACTORS
- 7 CHANGES IN THE WORK
- 8 TIME
- 9 PAYMENTS AND COMPLETION
- 10 PROTECTION OF PERSONS AND PROPERTY
- 11 INSURANCE AND BONDS
- 12 UNCOVERING AND CORRECTION OF WORK
- 13 MISCELLANEOUS PROVISIONS
- 14 TERMINATION OR SUSPENSION OF THE CONTRACT
- 15 CLAIMS AND DISPUTES

ADDITIONS AND DELETIONS:

The author of this document has added information needed for its completion. The author may also have revised the text of the original AIA standard form. An Additions and Deletions Report that notes added information as well as revisions to the standard form text is available from the author and should be reviewed.

This document has important legal consequences. Consultation with an attorney is encouraged with respect to its completion or modification.

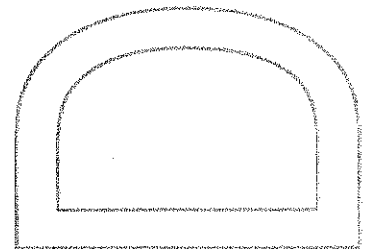

ELECTRONIC COPYING of any portion of this AIA Document to another electronic file is prohibited and constitutes a violation of copyright laws as set forth in the footer of this document.

INDEX

(Topics and numbers in bold are section headings.)

Acceptance of Nonconforming Work

9.6.6, 9.9.3, 12.3

Acceptance of Work

9.6.6, 9.8.2, 9.9.3, 9.10.1, 9.10.3, 12.3

Access to Work

3.16, 6.2.1, 12.1

Accident Prevention

10

Acts and Omissions

3.2, 3.3.2, 3.12.8, 3.18, 4.2.3, 8.3.1, 9.5.1, 10.2.5, 10.2.8, 13.4.2, 13.7, 14.1, 15.2

Addenda

1.1.1, 3.11.1

Additional Costs, Claims for

3.7.4, 3.7.5, 6.1.1, 7.3.7.5, 10.3, 15.1.4

Additional Inspections and Testing

9.4.2, 9.8.3, 12.2.1, 13.5

Additional Insured

11.1.4

Additional Time, Claims for

3.2.4, 3.7.4, 3.7.5, 3.10.2, 8.3.2, 15.1.5

Administration of the Contract

3.1.3, 4.2, 9.4, 9.5

Advertisement or Invitation to Bid

1.1.1

Aesthetic Effect

4.2.13

Allowances

3.8, 7.3.8

All-risk Insurance

11.3.1, 11.3.1.1

Applications for Payment

4.2.5, 7.3.9, 9.2, 9.3, 9.4, 9.5.1, 9.6.3, 9.7, 9.10, 11.1.3

Approvals

2.1.1, 2.2.2, 2.4, 3.1.3, 3.10.2, 3.12.8, 3.12.9, 3.12.10, 4.2.7, 9.3.2, 13.5.1

Arbitration

8.3.1, 11.3.10, 13.1.1, 15.3.2, 15.4

ENGINEER, OR HIS DESIGNEE

4

Engineer, or his designee, Definition of

4.1.1

Engineer, or his designee, Extent of Authority

2.4.1, 3.12.7, 4.1, 4.2, 5.2, 6.3, 7.1.2, 7.3.7, 7.4, 9.2, 9.3.1, 9.4, 9.5, 9.6.3, 9.8, 9.10.1, 9.10.3, 12.1, 12.2.1, 13.5.1, 13.5.2, 14.2.2, 14.2.4, 15.1.3, 15.2.1

Engineer, or his designee, Limitations of Authority and Responsibility

2.1.1, 3.12.4, 3.12.8, 3.12.10, 4.1.2, 4.2.1, 4.2.2, 4.2.3, 4.2.6, 4.2.7, 4.2.10, 4.2.12, 4.2.13, 5.2.1, 7.4, 9.4.2, 9.5.3, 9.6.4, 15.1.3, 15.2

Engineer, or his designee's Additional Services and Expenses

2.4.1, 11.3.1.1, 12.2.1, 13.5.2, 13.5.3, 14.2.4

Engineer, or his designee's Administration of the Contract

3.1.3, 4.2, 3.7.4, 15.2, 9.4.1, 9.5

Engineer, or his designee's Approvals

2.4.1, 3.1.3, 3.5, 3.10.2, 4.2.7

Engineer, or his designee's Authority to Reject Work

3.5, 4.2.6, 12.1.2, 12.2.1

Engineer, or his designee's Copyright

1.1.7, 1.5

Engineer, or his designee's Decisions

3.7.4, 4.2.6, 4.2.7, 4.2.11, 4.2.12, 4.2.13, 4.2.14, 6.3, 7.3.7, 7.3.9, 8.1.3, 8.3.1, 9.2, 9.4.1, 9.5, 9.8.7, 9.9.1, 13.5.2, 15.2, 15.3

Engineer, or his designee's Inspections

3.7.4, 4.2.2, 4.2.9, 9.4.2, 9.8.3, 9.9.2, 9.10.1, 13.5

Engineer, or his designee's Instructions

3.2.4, 3.3.1, 4.2.6, 4.2.7, 13.5.2

Engineer, or his designee's Interpretations

4.2.11, 4.2.12

Engineer, or his designee's Project Representative

4.2.10

Engineer, or his designee's Relationship with Contractor

1.1.2, 1.5, 3.1.3, 3.2.2, 3.2.3, 3.2.4, 3.3.1, 3.4.2, 3.5, 3.7.4, 3.7.5, 3.9.2, 3.9.3, 3.10, 3.11, 3.12, 3.16, 3.18, 4.1.2, 4.1.3, 4.2, 5.2, 6.2.2, 7, 8.3.1, 9.2, 9.3, 9.4, 9.5, 9.7, 9.8, 9.9, 10.2.6, 10.3, 11.3.7, 12, 13.4.2, 13.5, 15.2

Engineer, or his designee's Relationship with Subcontractors

1.1.2, 4.2.3, 4.2.4, 4.2.6, 9.6.3, 9.6.4, 11.3.7

Engineer, or his designee's Representations

9.4.2, 9.5.1, 9.10.1

Engineer, or his designee's Site Visits

3.7.4, 4.2.2, 4.2.9, 9.4.2, 9.5.1, 9.9.2, 9.10.1, 13.5

Asbestos

10.3.1

Attorneys' Fees

3.18.1, 9.10.2, 10.3.3

Award of Separate Contracts

6.1.1, 6.1.2

Award of Subcontracts and Other Contracts for Portions of the Work

5.2

Basic Definitions

1.1

Bidding Requirements

1.1.1, 5.2.1, 11.4.1

Binding Dispute Resolution

9.7, 11.3.9, 11.3.10, 13.1.1, 15.2.5, 15.2.6.1, 15.3.1, 15.3.2, 15.4.1

Boiler and Machinery Insurance
 11.3.2
Bonds, Lien
 7.3.7.4, 9.10.2, 9.10.3
Bonds, Performance, and Payment
 7.3.7.4, 9.6.7, 9.10.3, 11.3.9, 11.4
Building Permit
 3.7.1
Capitalization
 1.3
Certificate of Substantial Completion
 9.8.3, 9.8.4, 9.8.5
Certificates for Payment
 4.2.1, 4.2.5, 4.2.9, 9.3.3, 9.4, 9.5, 9.6.1, 9.6.6, 9.7,
 9.10.1, 9.10.3, 14.1.1.3, 14.2.4, 15.1.3
Certificates of Inspection, Testing or Approval
 13.5.4
Certificates of Insurance
 9.10.2, 11.1.3
Change Orders
 1.1.1, 2.4.1, 3.4.2, 3.7.4, 3.8.2.3, 3.11.1, 3.12.8, 4.2.8,
 5.2.3, 7.1.2, 7.1.3, 7.2, 7.3.2, 7.3.6, 7.3.9, 7.3.10,
 8.3.1, 9.3.1.1, 9.10.3, 10.3.2, 11.3.1.2, 11.3.4, 11.3.9,
 12.1.2, 15.1.3
Change Orders, Definition of
 7.2.1
CHANGES IN THE WORK
 2.2.1, 3.11, 4.2.8, 7, 7.2.1, 7.3.1, 7.4, 8.3.1, 9.3.1.1,
 11.3.9
Claims, Definition of
 15.1.1
CLAIMS AND DISPUTES
 3.2.4, 6.1.1, 6.3, 7.3.9, 9.3.3, 9.10.4, 10.3.3, 15, 15.4
Claims and Timely Assertion of Claims
 15.4.1
Claims for Additional Cost
 3.2.4, 3.7.4, 6.1.1, 7.3.9, 10.3.2, 15.1.4
Claims for Additional Time
 3.2.4, 3.7.4.6.1.1, 8.3.2, 10.3.2, 15.1.5
Concealed or Unknown Conditions, Claims for
 3.7.4
Claims for Damages
 3.2.4, 3.18, 6.1.1, 8.3.3, 9.5.1, 9.6.7, 10.3.3, 11.1.1,
 11.3.5, 11.3.7, 14.1.3, 14.2.4, 15.1.6
Claims Subject to Arbitration
 15.3.1, 15.4.1
Cleaning Up
 3.15, 6.3
Commencement of the Work, Conditions Relating to
 2.2.1, 3.2.2, 3.4.1, 3.7.1, 3.10.1, 3.12.6, 5.2.1, 5.2.3,
 6.2.2, 8.1.2, 8.2.2, 8.3.1, 11.1, 11.3.1, 11.3.6, 11.4.1,
 15.1.4
Commencement of the Work, Definition of
 8.1.2
Communications Facilitating Contract Administration
 3.9.1, 4.2.4

Completion, Conditions Relating to
 3.4.1, 3.11, 3.15, 4.2.2, 4.2.9, 8.2, 9.4.2, 9.8, 9.9.1,
 9.10, 12.2, 13.7, 14.1.2
COMPLETION, PAYMENTS AND
 9
Completion, Substantial
 4.2.9, 8.1.1, 8.1.3, 8.2.3, 9.4.2, 9.8, 9.9.1, 9.10.3,
 12.2, 13.7
Compliance with Laws
 1.6.1, 3.2.3, 3.6, 3.7, 3.12.10, 3.13, 4.1.1, 9.6.4,
 10.2.2, 11.1, 11.3, 13.1, 13.4, 13.5.1, 13.5.2, 13.6,
 14.1.1, 14.2.1.3, 15.2.8, 15.4.2, 15.4.3
Concealed or Unknown Conditions
 3.7.4, 4.2.8, 8.3.1, 10.3
Conditions of the Contract
 1.1.1, 6.1.1, 6.1.4
Consent, Written
 3.4.2, 3.7.4, 3.12.8, 3.14.2, 4.1.2, 9.3.2, 9.8.5, 9.9.1,
 9.10.2, 9.10.3, 11.3.1, 13.2, 13.4.2, 15.4.4.2
Consolidation or Joinder
 15.4.4
CONSTRUCTION BY OWNER OR BY SEPARATE CONTRACTORS
 1.1.4, 6
Construction Change Directive, Definition of
 7.3.1
Construction Change Directives
 1.1.1, 3.4.2, 3.12.8, 4.2.8, 7.1.1, 7.1.2, 7.1.3, 7.3,
 9.3.1.1
Construction Schedules, Contractor's
 3.10, 3.12.1, 3.12.2, 6.1.3, 15.1.5.2
Contingent Assignment of Subcontracts
 5.4, 14.2.2.2
Continuing Contract Performance
 15.1.3
Contract, Definition of
 1.1.2
CONTRACT, TERMINATION OR SUSPENSION OF THE
 5.4.1.1, 11.3.9, 14
Contract Administration
 3.1.3, 4, 9.4, 9.5
Contract Award and Execution, Conditions Relating to
 3.7.1, 3.10, 5.2, 6.1, 11.1.3, 11.3.6, 11.4.1
Contract Documents, Copies Furnished and Use of
 1.5.2, 2.2.5, 5.3
Contract Documents, Definition of
 1.1.1
Contract Sum
 3.7.4, 3.8, 5.2.3, 7.2, 7.3, 7.4, 9.1, 9.4.2, 9.5.1.4,
 9.6.7, 9.7, 10.3.2, 11.3.1, 14.2.4, 14.3.2, 15.1.4,
 15.2.5
Contract Sum, Definition of
 9.1

Contract Time
3.7.4, 3.7.5, 3.10.2, 5.2.3, 7.2.1.3, 7.3.1, 7.3.5, 7.4,
8.1.1, 8.2.1, 8.3.1, 9.5.1, 9.7, 10.3.2, 12.1.1, 14.3.2,
15.1.5.1, 15.2.5

Contract Time, Definition of
8.1.1

CONTRACTOR
3

Contractor, Definition of
3.1, 6.1.2

Contractor's Construction Schedules
3.10, 3.12.1, 3.12.2, 6.1.3, 15.1.5.2

Contractor's Employees
3.3.2, 3.4.3, 3.8.1, 3.9, 3.18.2, 4.2.3, 4.2.6, 10.2, 10.3,
11.1.1, 11.3.7, 14.1, 14.2.1.1

Contractor's Liability Insurance
11.1

Contractor's Relationship with Separate Contractors
and Owner's Forces
3.12.5, 3.14.2, 4.2.4, 6, 11.3.7, 12.1.2, 12.2.4

Contractor's Relationship with Subcontractors
1.2.2, 3.3.2, 3.18.1, 3.18.2, 5, 9.6.2, 9.6.7, 9.10.2,
11.3.1.2, 11.3.7, 11.3.8

Contractor's Relationship with the Engineer, or his
designee
1.1.2, 1.5, 3.1.3, 3.2.2, 3.2.3, 3.2.4, 3.3.1, 3.4.2, 3.5,
3.7.4, 3.10, 3.11, 3.12, 3.16, 3.18, 4.1.3, 4.2, 5.2,
6.2.2, 7, 8.3.1, 9.2, 9.3, 9.4, 9.5, 9.7, 9.8, 9.9, 10.2.6,
10.3, 11.3.7, 12, 13.5, 15.1.2, 15.2.1

Contractor's Representations
3.2.1, 3.2.2, 3.5, 3.12.6, 6.2.2, 8.2.1, 9.3.3, 9.8.2

Contractor's Responsibility for Those Performing the
Work
3.3.2, 3.18, 5.3.1, 6.1.3, 6.2, 9.5.1, 10.2.8

Contractor's Review of Contract Documents
3.2

Contractor's Right to Stop the Work
9.7

Contractor's Right to Terminate the Contract
14.1, 15.1.6

Contractor's Submittals
3.10, 3.11, 3.12.4, 4.2.7, 5.2.1, 5.2.3, 9.2, 9.3, 9.8.2,
9.8.3, 9.9.1, 9.10.2, 9.10.3, 11.1.3, 11.4.2

Contractor's Superintendent
3.9, 10.2.6

Contractor's Supervision and Construction
Procedures
1.2.2, 3.3, 3.4, 3.12.10, 4.2.2, 4.2.7, 6.1.3, 6.2.4,
7.1.3, 7.3.5, 7.3.7, 8.2, 10, 12, 14, 15.1.3

Contractual Liability Insurance
11.1.1.8, 11.2

Coordination and Correlation
1.2, 3.2.1, 3.3.1, 3.10, 3.12.6, 6.1.3, 6.2.1

Copies Furnished of Drawings and Specifications
1.5, 2.2.5, 3.11

Copyrights
1.5, 3.17

Correction of Work
2.3, 2.4, 3.7.3, 9.4.2, 9.8.2, 9.8.3, 9.9.1, 12.1.2, 12.2

Correlation and Intent of the Contract Documents
1.2

Cost, Definition of
7.3.7

Costs
2.4.1, 3.2.4, 3.7.3, 3.8.2, 3.15.2, 5.4.2, 6.1.1, 6.2.3,
7.3.3.3, 7.3.7, 7.3.8, 7.3.9, 9.10.2, 10.3.2, 10.3.6,
11.3, 12.1.2, 12.2.1, 12.2.4, 13.5, 14

Cutting and Patching
3.14, 6.2.5

Damage to Construction of Owner or Separate
Contractors
3.14.2, 6.2.4, 10.2.1.2, 10.2.5, 10.4, 11.1.1, 11.3,
12.2.4

Damage to the Work
3.14.2, 9.9.1, 10.2.1.2, 10.2.5, 10.4.1, 11.3.1, 12.2.4

Damages, Claims for
3.2.4, 3.18, 6.1.1, 8.3.3, 9.5.1, 9.6.7, 10.3.3, 11.1.1,
11.3.5, 11.3.7, 14.1.3, 14.2.4, 15.1.6

Damages for Delay
6.1.1, 8.3.3, 9.5.1.6, 9.7, 10.3.2

Date of Commencement of the Work, Definition of
8.1.2

Date of Substantial Completion, Definition of
8.1.3

Day, Definition of
8.1.4

Decisions of the Engineer, or his designee
3.7.4, 4.2.6, 4.2.7, 4.2.11, 4.2.12, 4.2.13, 15.2, 6.3,
7.3.7, 7.3.9, 8.1.3, 8.3.1, 9.2, 9.4, 9.5.1, 9.8.4, 9.9.1,
13.5.2, 14.2.2, 14.2.4, 15.1, 15.2

Decisions to Withhold Certification
9.4.1, 9.5, 9.7, 14.1.1.3

Defective or Nonconforming Work, Acceptance,
Rejection and Correction of
2.3.1, 2.4.1, 3.5, 4.2.6, 6.2.5, 9.5.1, 9.5.2, 9.6.6, 9.8.2,
9.9.3, 9.10.4, 12.2.1

Definitions
1.1, 2.1.1, 3.1.1, 3.5, 3.12.1, 3.12.2, 3.12.3, 4.1.1,
15.1.1, 5.1, 6.1.2, 7.2.1, 7.3.1, 8.1, 9.1, 9.8.1

Delays and Extensions of Time
3.2, 3.7.4, 5.2.3, 7.2.1, 7.3.1, 7.4, 8.3, 9.5.1, 9.7,
10.3.2, 10.4.1, 14.3.2, 15.1.5, 15.2.5

Disputes
6.3, 7.3.9, 15.1, 15.2

Documents and Samples at the Site
3.11

Drawings, Definition of
1.1.5

Drawings and Specifications, Use and Ownership of
3.11

Effective Date of Insurance
8.2.2, 11.1.2

Emergencies
10.4, 14.1.1.2, 15.1.4

Employees, Contractor's
3.3.2, 3.4.3, 3.8.1, 3.9, 3.18.2, 4.2.3, 4.2.6, 10.2,
10.3.3, 11.1.1, 11.3.7, 14.1, 14.2.1.1

Equipment, Labor, Materials or
1.1.3, 1.1.6, 3.4, 3.5, 3.8.2, 3.8.3, 3.12, 3.13.1, 3.15.1,
4.2.6, 4.2.7, 5.2.1, 6.2.1, 7.3.7, 9.3.2, 9.3.3, 9.5.1.3,
9.10.2, 10.2.1, 10.2.4, 14.2.1.1, 14.2.1.2

Execution and Progress of the Work
1.1.3, 1.2.1, 1.2.2, 2.2.3, 2.2.5, 3.1, 3.3.1, 3.4.1, 3.5,
3.7.1, 3.10.1, 3.12, 3.14, 4.2, 6.2.2, 7.1.3, 7.3.5, 8.2,
9.5.1, 9.9.1, 10.2, 10.3, 12.2, 14.2, 14.3.1, 15.1.3

Extensions of Time
3.2.4, 3.7.4, 5.2.3, 7.2.1, 7.3, 7.4, 9.5.1, 9.7, 10.3.2,
10.4.1, 14.3, 15.1.5, 15.2.5

Failure of Payment
9.5.1.3, 9.7, 9.10.2, 13.6, 14.1.1.3, 14.2.1.2

Faulty Work
(See Defective or Nonconforming Work)

Final Completion and Final Payment
4.2.1, 4.2.9, 9.8.2, 9.10, 11.1.2, 11.1.3, 11.3.1, 11.3.5,
12.3.1, 14.2.4, 14.4.3

Financial Arrangements, Owner's
2.2.1, 13.2.2, 14.1.1.4

Fire and Extended Coverage Insurance
11.3.1.1

GENERAL PROVISIONS

1

Governing Law

13.1

Guarantees (See Warranty)

Hazardous Materials
10.2.4, 10.3

Identification of Subcontractors and Suppliers
5.2.1

Indemnification
3.1.7, 3.18, 9.10.2, 10.3.3, 10.3.5, 10.3.6, 11.3.1.2,
11.3.7

Information and Services Required of the Owner
2.1.2, 2.2, 3.2.2, 3.12.4, 3.12.10, 6.1.3, 6.1.4, 6.2.5,
9.6.1, 9.6.4, 9.9.2, 9.10.3, 10.3.3, 11.2, 11.4, 13.5.1,
13.5.2, 14.1.1.4, 14.1.4, 15.1.3

Initial Decision
15.2

Initial Decision Maker, Definition of
1.1.8

Initial Decision Maker, Decisions
14.2.2, 14.2.4, 15.2.1, 15.2.2, 15.2.3, 15.2.4, 15.2.5

Initial Decision Maker, Extent of Authority
14.2.2, 14.2.4, 15.1.3, 15.2.1, 15.2.2, 15.2.3, 15.2.4,
15.2.5

Injury or Damage to Person or Property
10.2.8, 10.4.1

Inspections
3.1.3, 3.3.3, 3.7.1, 4.2.2, 4.2.6, 4.2.9, 9.4.2, 9.8.3,
9.9.2, 9.10.1, 12.2.1, 13.5

Instructions to Bidders
1.1.1

Instructions to the Contractor
3.2.4, 3.3.1, 3.8.1, 5.2.1, 7, 8.2.2, 12, 13.5.2

Instruments of Service, Definition of
1.1.7

Insurance
3.18.1, 6.1.1, 7.3.7, 9.3.2, 9.8.4, 9.9.1, 9.10.2, 11

Insurance, Boiler and Machinery
11.3.2

Insurance, Contractor's Liability
11.1

Insurance, Effective Date of
8.2.2, 11.1.2

Insurance, Loss of Use
11.3.3

Insurance, Owner's Liability
11.2

Insurance, Property
10.2.5, 11.3

Insurance, Stored Materials
9.3.2

INSURANCE AND BONDS
11

Insurance Companies, Consent to Partial Occupancy
9.9.1

Intent of the Contract Documents
1.2.1, 4.2.7, 4.2.12, 4.2.13, 7.4

Interest
13.6

Interpretation
1.2.3, 1.4, 4.1.1, 5.1, 6.1.2, 15.1.4

Interpretations, Written
4.2.11, 4.2.12, 15.1.4

Judgment on Final Award
15.4.2

Labor and Materials, Equipment
1.1.3, 1.1.6, 3.4, 3.5, 3.8.2, 3.8.3, 3.12, 3.13, 3.15.1,
4.2.6, 4.2.7, 5.2.1, 6.2.1, 7.3.7, 9.3.2, 9.3.3, 9.5.1.3,
9.10.2, 10.2.1, 10.2.4, 14.2.1.1, 14.2.1.2

Labor Disputes
8.3.1

Laws and Regulations
1.5, 3.2.3, 3.6, 3.7, 3.12.10, 5.13.1, 4.1.1, 9.6.4, 9.9.1,
10.2.2, 11.1.1, 11.3, 13.1.1, 13.4, 13.5.1, 13.5.2,
13.6.1, 14, 15.2.8, 15.4

Liens
2.1.2, 9.3.3, 9.10.2, 9.10.4, 15.2.8

Limitations, Statutes of
12.2.5, 13.7, 15.4.1.1

Limitations of Liability
2.3.1, 3.2.2, 3.5, 3.12.10, 3.17, 3.18.1, 4.2.6, 4.2.7,
4.2.12, 6.2.2, 9.4.2, 9.6.4, 9.6.7, 10.2.5, 10.3.3,
11.1.2, 11.2, 11.3.7, 12.2.5, 13.4.2

Limitations of Time
2.1.2, 2.2, 2.4, 3.2.2, 3.10, 3.11, 3.12.5, 3.15.1, 4.2.7,
5.2, 5.3.1, 5.4.1, 6.2.4, 7.3, 7.4, 8.2, 9.2, 9.3.1, 9.3.3,
9.4.1, 9.5, 9.6, 9.7, 9.8, 9.9, 9.10, 11.1.3, 11.3.1.5,
11.3.6, 11.3.10, 12.2, 13.5, 13.7, 14, 15

Loss of Use Insurance
 11.3.3
Material Suppliers
 1.5, 3.12.1, 4.2.4, 4.2.6, 5.2.1, 9.3, 9.4.2, 9.6, 9.10.5
Materials, Hazardous
 10.2.4, 10.3
Materials, Labor, Equipment and
 1.1.3, 1.1.6, 1.5.1, 3.4.1, 3.5, 3.8.2, 3.8.3, 3.12,
 3.13.1, 3.15.1, 4.2.6, 4.2.7, 5.2.1, 6.2.1, 7.3.7, 9.3.2,
 9.3.3, 9.5.1.3, 9.10.2, 10.2.1.2, 10.2.4, 14.2.1.1,
 14.2.1.2
Means, Methods, Techniques, Sequences and
Procedures of Construction
 3.3.1, 3.12.10, 4.2.2, 4.2.7, 9.4.2
Mechanic's Lien
 2.1.2, 15.2.8
Mediation
 8.3.1, 10.3.5, 10.3.6, 15.2.1, 15.2.5, 15.2.6, 15.3,
 15.4.1
Minor Changes in the Work
 1.1.1, 3.12.8, 4.2.8, 7.1, 7.4
MISCELLANEOUS PROVISIONS
 13
Modifications, Definition of
 1.1.1
Modifications to the Contract
 1.1.1, 1.1.2, 3.11, 4.1.2, 4.2.1, 5.2.3, 7, 8.3.1, 9.7,
 10.3.2, 11.3.1
Mutual Responsibility
 6.2
Nonconforming Work, Acceptance of
 9.6.6, 9.9.3, 12.3
Nonconforming Work, Rejection and Correction of
 2.3.1, 2.4.1, 3.5, 4.2.6, 6.2.4, 9.5.1, 9.8.2, 9.9.3,
 9.10.4, 12.2.1
Notice
 2.2.1, 2.3.1, 2.4.1, 3.2.4, 3.3.1, 3.7.2, 3.12.9, 5.2.1,
 9.7, 9.10, 10.2.2, 11.1.3, 12.2.2.1, 13.3, 13.5.1,
 13.5.2, 14.1, 14.2, 15.2.8, 15.4.1
Notice, Written
 2.3.1, 2.4.1, 3.3.1, 3.9.2, 3.12.9, 3.12.10, 5.2.1, 9.7,
 9.10, 10.2.2, 10.3, 11.1.3, 11.3.6, 12.2.2.1, 13.3, 14,
 15.2.8, 15.4.1
Notice of Claims
 3.7.4, 10.2.8, 15.1.2, 15.4
Notice of Testing and Inspections
 13.5.1, 13.5.2
Observations, Contractor's
 3.2, 3.7.4
Occupancy
 2.2.2, 9.6.6, 9.8, 11.3.1.5
Orders, Written
 1.1.1, 2.3, 3.9.2, 7, 8.2.2, 11.3.9, 12.1, 12.2.2.1,
 13.5.2, 14.3.1
OWNER
 2

Owner, Definition of
 2.1.1
Owner, Information and Services Required of the
 2.1.2, 2.2, 3.2.2, 3.12.10, 6.1.3, 6.1.4, 6.2.5, 9.3.2,
 9.6.1, 9.6.4, 9.9.2, 9.10.3, 10.3.3, 11.2, 11.3, 13.5.1,
 13.5.2, 14.1.1.4, 14.1.4, 15.1.3
Owner's Authority
 1.5, 2.1.1, 2.3.1, 2.4.1, 3.4.2, 3.8.1, 3.12.10, 3.14.2,
 4.1.2, 4.1.3, 4.2.4, 4.2.9, 5.2.1, 5.2.4, 5.4.1, 6.1, 6.3,
 7.2.1, 7.3.1, 8.2.2, 8.3.1, 9.3.1, 9.3.2, 9.3.1, 9.6.4,
 9.9.1, 9.10.2, 10.3.2, 11.1.3, 11.3.3, 11.3.10, 12.2.2,
 12.3.1, 13.2.2, 14.3, 14.4, 15.2.7
Owner's Financial Capability
 2.2.1, 13.2.2, 14.1.1.4
Owner's Liability Insurance
 11.2
Owner's Relationship with Subcontractors
 1.1.2, 5.2, 5.3, 5.4, 9.6.4, 9.10.2, 14.2.2
Owner's Right to Carry Out the Work
 2.4, 14.2.2
Owner's Right to Clean Up
 6.3
Owner's Right to Perform Construction and to
Award Separate Contracts
 6.1
Owner's Right to Stop the Work
 2.3
Owner's Right to Suspend the Work
 14.3
Owner's Right to Terminate the Contract
 14.2
Ownership and Use of Drawings, Specifications
and Other Instruments of Service
 1.1.1, 1.1.6, 1.1.7, 1.5, 2.2.5, 3.2.2, 3.11.1, 3.17,
 4.2.12, 5.3.1
Partial Occupancy or Use
 9.6.6, 9.9, 11.3.1.5
Patching, Cutting and
 3.14, 6.2.5
Patents
 3.17
Payment, Applications for
 4.2.5, 7.3.9, 9.2, 9.3, 9.4, 9.5, 9.6.3, 9.7, 9.8.5, 9.10.1,
 14.2.3, 14.2.4, 14.4.3
Payment, Certificates for
 4.2.5, 4.2.9, 9.3.3, 9.4, 9.5, 9.6.1, 9.6.6, 9.7, 9.10.1,
 9.10.3, 13.7, 14.1.1.3, 14.2.4
Payment, Failure of
 9.5.1.3, 9.7, 9.10.2, 13.6, 14.1.1.3, 14.2.1.2
Payment, Final
 4.2.1, 4.2.9, 9.8.2, 9.10, 11.1.2, 11.1.3, 11.4.1, 12.3.1,
 13.7, 14.2.4, 14.4.3
Payment Bond, Performance Bond and
 7.3.7.4, 9.6.7, 9.10.3, 11.4
Payments, Progress
 9.3, 9.6, 9.8.5, 9.10.3, 13.6, 14.2.3, 15.1.3

PAYMENTS AND COMPLETION

- 9
- Payments to Subcontractors
 - 5.4.2, 9.5.1.3, 9.6.2, 9.6.3, 9.6.4, 9.6.7, 14.2.1.2
- PCB
 - 10.3.1
- Performance Bond and Payment Bond
 - 7.3.7.4, 9.6.7, 9.10.3, 11.4
- Permits, Fees, Notices and Compliance with Laws
 - 2.2.2, 3.7, 3.13, 7.3.7.4, 10.2.2

PERSONS AND PROPERTY, PROTECTION OF

- 10
- Polychlorinated Biphenyl
 - 10.3.1
- Product Data, Definition of
 - 3.12.2
- Product Data and Samples, Shop Drawings
 - 3.11, 3.12, 4.2.7
- Progress and Completion
 - 4.2.2, 8.2, 9.8, 9.9.1, 14.1.4, 15.1.3
- Progress Payments
 - 9.3, 9.6, 9.8.5, 9.10.3, 13.6, 14.2.3, 15.1.3
- Project, Definition of
 - 1.1.4
- Project Representatives
 - 4.2.10
- Property Insurance
 - 10.2.5, 11.3

PROTECTION OF PERSONS AND PROPERTY

- 10
- Regulations and Laws
 - 1.5, 3.2.3, 3.6, 3.7, 3.12.10, 3.13, 4.1.1, 9.6.4, 9.9.1, 10.2.2, 11.1, 11.4, 13.1, 13.4, 13.5.1, 13.5.2, 13.6, 14, 15.2.8, 15.4
- Rejection of Work
 - 3.5, 4.2.6, 12.2.1
- Releases and Waivers of Liens
 - 9.10.2
- Representations
 - 3.2.1, 3.5, 3.12.6, 6.2.2, 8.2.1, 9.3.3, 9.4.2, 9.5.1, 9.8.2, 9.10.1
- Representatives
 - 2.1.1, 3.1.1, 3.9, 4.1.1, 4.2.1, 4.2.2, 4.2.10, 5.1.1, 5.1.2, 13.2.1
- Responsibility for Those Performing the Work
 - 3.3.2, 3.18, 4.2.3, 5.3.1, 6.1.3, 6.2, 6.3, 9.5.1, 10
- Retainage
 - 9.3.1, 9.6.2, 9.8.5, 9.9.1, 9.10.2, 9.10.3
- Review of Contract Documents and Field Conditions by Contractor
 - 3.2, 3.12.7, 6.1.3
- Review of Contractor's Submittals by Owner and Engineer, or his designee
 - 3.10.1, 3.10.2, 3.11, 3.12, 4.2, 5.2, 6.1.3, 9.2, 9.8.2

- Review of Shop Drawings, Product Data and Samples by Contractor
 - 3.12
- Rights and Remedies
 - 1.1.2, 2.3, 2.4, 3.5, 3.7.4, 3.15.2, 4.2.6, 5.3, 5.4, 6.1, 6.3, 7.3.1, 8.3, 9.5.1, 9.7, 10.2.5, 10.3, 12.2.2, 12.2.4, 13.4, 14, 15.4
- Royalties, Patents and Copyrights
 - 3.17
- Rules and Notices for Arbitration
 - 15.4.1
- Safety of Persons and Property
 - 10.2, 10.4
- Safety Precautions and Programs
 - 3.3.1, 4.2.2, 4.2.7, 5.3.1, 10.1, 10.2, 10.4
- Samples, Definition of
 - 3.12.3
- Samples, Shop Drawings, Product Data and
 - 3.11, 3.12, 4.2.7
- Samples at the Site, Documents and
 - 3.11
- Schedule of Values
 - 9.2, 9.3.1
- Schedules, Construction
 - 3.10, 3.12.1, 3.12.2, 6.1.3, 15.1.5.2
- Separate Contracts and Contractors
 - 1.1.4, 3.12.5, 3.14.2, 4.2.4, 4.2.7, 6, 8.3.1, 12.1.2
- Shop Drawings, Definition of
 - 3.12.1
- Shop Drawings, Product Data and Samples
 - 3.11, 3.12, 4.2.7
- Site, Use of
 - 3.13, 6.1.1, 6.2.1
- Site Inspections
 - 3.2.2, 3.3.3, 3.7.1, 3.7.4, 4.2, 9.4.2, 9.10.1, 13.5
- Site Visits, Engineer, or his designee's
 - 3.7.4, 4.2.2, 4.2.9, 9.4.2, 9.5.1, 9.9.2, 9.10.1, 13.5
- Special Inspections and Testing
 - 4.2.6, 12.2.1, 13.5
- Specifications, Definition of
 - 1.1.6
- Specifications
 - 1.1.1, 1.1.6, 1.2.2, 1.5, 3.11, 3.12.10, 3.17, 4.2.14
- Statute of Limitations
 - 13.7, 15.4.1.1
- Stopping the Work
 - 2.3, 9.7, 10.3, 14.1
- Stored Materials
 - 6.2.1, 9.3.2, 10.2.1.2, 10.2.4
- Subcontractor, Definition of
 - 5.1.1
- SUBCONTRACTORS**
- 5
- Subcontractors, Work by
 - 1.2.2, 3.3.2, 3.12.1, 4.2.3, 5.2.3, 5.3, 5.4, 9.3.1.2, 9.6.7

Subcontractual Relations
5.3, 5.4, 9.3.1.2, 9.6, 9.10, 10.2.1, 14.1, 14.2.1

Submittals
3.10, 3.11, 3.12, 4.2.7, 5.2.1, 5.2.3, 7.3.7, 9.2, 9.3,
9.8, 9.9.1, 9.10.2, 9.10.3, 11.1.3

Submittal Schedule
3.10.2, 3.12.5, 4.2.7

Subrogation, Waivers of
6.1.1, 11.3.7

Substantial Completion
4.2.9, 8.1.1, 8.1.3, 8.2.3, 9.4.2, 9.8, 9.9.1, 9.10.3,
12.2, 13.7

Substantial Completion, Definition of
9.8.1

Substitution of Subcontractors
5.2.3, 5.2.4

Substitution of Engineer, or his designee
4.1.3

Substitutions of Materials
3.4.2, 3.5, 7.3.8

Sub-subcontractor, Definition of
5.1.2

Subsurface Conditions
3.7.4

Successors and Assigns
13.2

Superintendent
3.9, 10.2.6

Supervision and Construction Procedures
1.2.2, 3.3, 3.4, 3.12.10, 4.2.2, 4.2.7, 6.1.3, 6.2.4,
7.1.3, 7.3.7, 8.2, 8.3.1, 9.4.2, 10, 12, 14, 15.1.3

Surety
5.4.1.2, 9.8.5, 9.10.2, 9.10.3, 14.2.2, 15.2.7

Surety, Consent of
9.10.2, 9.10.3

Surveys
2.2.3

Suspension by the Owner for Convenience
14.3

Suspension of the Work
5.4.2, 14.3

Suspension or Termination of the Contract
5.4.1.1, 14

Taxes
3.6, 3.8.2.1, 7.3.7.4

Termination by the Contractor
14.1, 15.1.6

Termination by the Owner for Cause
5.4.1.1, 14.2, 15.1.6

Termination by the Owner for Convenience
14.4

Termination of the Engineer, or his designee
4.1.3

Termination of the Contractor
14.2.2

TERMINATION OR SUSPENSION OF THE CONTRACT

14

Tests and Inspections
3.1.3, 3.3.3, 4.2.2, 4.2.6, 4.2.9, 9.4.2, 9.8.3, 9.9.2,
9.10.1, 10.3.2, 11.4.1.1, 12.2.1, 13.5

TIME
8

Time, Delays and Extensions of
3.2.4, 3.7.4, 5.2.3, 7.2.1, 7.3.1, 7.4, 8.3, 9.5.1, 9.7,
10.3.2, 10.4.1, 14.3.2, 15.1.5, 15.2.5

Time Limits
2.1.2, 2.2, 2.4, 3.2.2, 3.10, 3.11, 3.12.5, 3.15.1, 4.2,
5.2, 5.3, 5.4, 6.2.4, 7.3, 7.4, 8.2, 9.2, 9.3.1, 9.3.3,
9.4.1, 9.5, 9.6, 9.7, 9.8, 9.9, 9.10, 11.1.3, 12.2, 13.5,
13.7, 14, 15.1.2, 15.4

Time Limits on Claims
3.7.4, 10.2.8, 13.7, 15.1.2

Title to Work
9.3.2, 9.3.3

Transmission of Data in Digital Form
1.6

UNCOVERING AND CORRECTION OF WORK
12

Uncovering of Work
12.1

Unforeseen Conditions, Concealed or Unknown
3.7.4, 8.3.1, 10.3

Unit Prices
7.3.3.2, 7.3.4

Use of Documents
1.1.1, 1.5, 2.2.5, 3.12.6, 5.3

Use of Site
3.13, 6.1.1, 6.2.1

Values, Schedule of
9.2, 9.3.1

Waiver of Claims by the Engineer, or his designee
13.4.2

Waiver of Claims by the Contractor
9.10.5, 13.4.2, 15.1.6

Waiver of Claims by the Owner
9.9.3, 9.10.3, 9.10.4, 12.2.2.1, 13.4.2, 14.2.4, 15.1.6

Waiver of Consequential Damages
14.2.4, 15.1.6

Waiver of Liens
9.10.2, 9.10.4

Waivers of Subrogation
6.1.1, 11.3.7

Warranty
3.5, 4.2.9, 9.3.3, 9.8.4, 9.9.1, 9.10.4, 12.2.2, 13.7

Weather Delays
15.1.5.2

Work, Definition of
1.1.3

Use of Site

Written Consent

1.5.2, 3.4.2, 3.7.4, 3.12.8, 3.14.2, 4.1.2, 9.3.2, 9.8.5, 9.9.1, 9.10.2, 9.10.3, 11.4.1, 13.2, 13.4.2, 15.4.4.2

Written Interpretations

4.2.11, 4.2.12

Written Notice

2.3, 2.4, 3.3.1, 3.9, 3.12.9, 3.12.10, 5.2.1, 8.2.2, 9.7, 9.10, 10.2.2, 10.3, 11.1.3, 12.2.2, 12.2.4, 13.3, 14, 15.4.1

Written Orders

1.1.1, 2.3, 3.9, 7, 8.2.2, 12.1, 12.2, 13.5.2, 14.3.1, 15.1.2

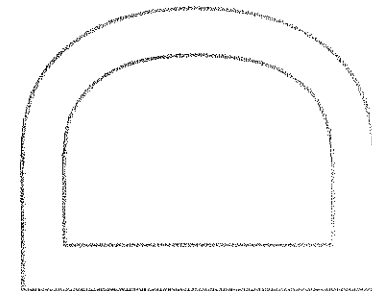
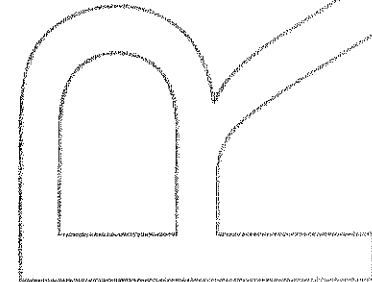
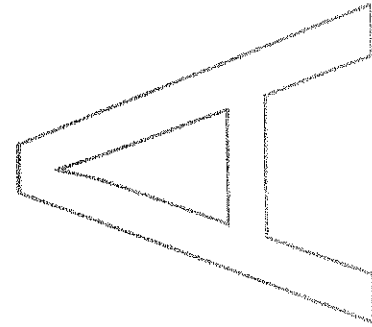
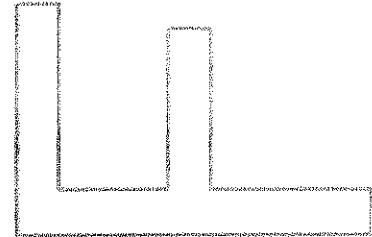
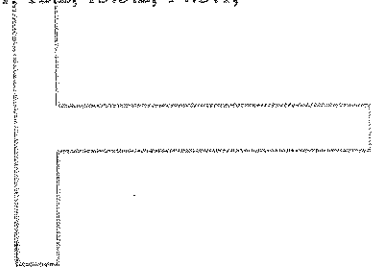

ARTICLE 1 GENERAL PROVISIONS

§ 1.1 BASIC DEFINITIONS

§ 1.1.1 THE CONTRACT DOCUMENTS

The Contract Documents are enumerated in the Agreement between the Owner and Contractor (hereinafter the Agreement) and consist of the Agreement, Conditions of the Contract (General, Supplementary and other Conditions), Drawings, Specifications, Addenda issued prior to execution of the Contract, other documents listed in the Agreement and Modifications issued after execution of the Contract. A Modification is (1) a written amendment to the Contract signed by both parties, (2) a Change Order, (3) a Construction Change Directive or (4) a written order for a minor change in the Work issued by the Architect or Engineer. Unless specifically enumerated in the Agreement, the Contract Documents do not include the advertisement or invitation to bid, Instructions to Bidders, sample forms, other information furnished by the Owner in anticipation of receiving bids or proposals, the Contractor's bid or proposal, or portions of Addenda relating to bidding requirements.

§ 1.1.2 THE CONTRACT

The Contract Documents form the Contract for Construction. The Contract represents the entire and integrated agreement between the parties hereto and supersedes prior negotiations, representations or agreements, either written or oral. The Contract may be amended or modified only by a Modification. The Contract Documents shall not be construed to create a contractual relationship of any kind (1) between the Contractor and the Engineer, or his designee or the Engineer, or his designee's consultants, (2) between the Owner and a Subcontractor or a Sub-subcontractor, (3) between the Owner and the Engineer, or his designee or the Engineer, or his designee's consultants or (4) between any persons or entities other than the Owner and the Contractor. The Engineer, or his designee shall, however, be entitled to performance and enforcement of obligations under the Contract intended to facilitate performance of the Engineer, or his designee's duties.

§ 1.1.3 THE WORK

The term "Work" means the construction and services required by the Contract Documents, whether completed or partially completed, and includes all other labor, materials, equipment and services provided or to be provided by the Contractor to fulfill the Contractor's obligations. The Work may constitute the whole or a part of the Project.

§ 1.1.4 THE PROJECT

The Project is the total construction of which the Work performed under the Contract Documents may be the whole or a part and which may include construction by the Owner and by separate contractors.

§ 1.1.5 THE DRAWINGS

The Drawings are the graphic and pictorial portions of the Contract Documents showing the design, location and dimensions of the Work, generally including plans, elevations, sections, details, schedules and diagrams.

§ 1.1.6 THE SPECIFICATIONS

The Specifications are that portion of the Contract Documents consisting of the written requirements for materials, equipment, systems, standards and workmanship for the Work, and performance of related services.

§ 1.1.7 INSTRUMENTS OF SERVICE

Instruments of Service are representations, in any medium of expression now known or later developed, of the tangible and intangible creative work performed by the Engineer, or his designee and the Engineer, or his designee's consultants under their respective professional services agreements. Instruments of Service may include, without limitation, studies, surveys, models, sketches, drawings, specifications, and other similar materials.

§ 1.1.8 INITIAL DECISION MAKER

The Initial Decision Maker is the person identified in the Agreement to render initial decisions on Claims in accordance with Section 15.2 and certify termination of the Agreement under Section 14.2.2.

§ 1.2 CORRELATION AND INTENT OF THE CONTRACT DOCUMENTS

§ 1.2.1 The intent of the Contract Documents is to include all items necessary for the proper execution and completion of the Work by the Contractor. The Contract Documents are complementary, and what is required by one shall be as binding as if required by all; performance by the Contractor shall be required only to the extent

consistent with the Contract Documents and reasonably inferable from them as being necessary to produce the indicated results.

§ 1.2.2 Organization of the Specifications into divisions, sections and articles, and arrangement of Drawings shall not control the Contractor in dividing the Work among Subcontractors or in establishing the extent of Work to be performed by any trade.

§ 1.2.3 Unless otherwise stated in the Contract Documents, words that have well-known technical or construction industry meanings are used in the Contract Documents in accordance with such recognized meanings.

§ 1.3 CAPITALIZATION

Terms capitalized in these General Conditions include those that are (1) specifically defined, (2) the titles of numbered articles or (3) the titles of other documents published by the American Institute of Engineer, or his designee s.

§ 1.4 INTERPRETATION

In the interest of brevity the Contract Documents frequently omit modifying words such as "all" and "any" and articles such as "the" and "an," but the fact that a modifier or an article is absent from one statement and appears in another is not intended to affect the interpretation of either statement.

§ 1.5 OWNERSHIP AND USE OF DRAWINGS, SPECIFICATIONS AND OTHER INSTRUMENTS OF SERVICE

§ 1.5.1 The Engineer, or his designee and the Engineer, or his designee 's consultants shall be deemed the authors and Owners of their respective Instruments of Service, including the Drawings and Specifications. The Contractor, Subcontractors, Sub-subcontractors, and material or equipment suppliers shall not own or claim a copyright in the Instruments of Service. Submittal or distribution to meet official regulatory requirements or for other purposes in connection with this Project is not to be construed as publication in derogation of the Engineer, or his designee or Engineer, or his designee 's consultants' reserved rights.

§ 1.5.2 The Contractor, Subcontractors, Sub-subcontractors and material or equipment suppliers are authorized to use and reproduce the Instruments of Service provided to them solely and exclusively for execution of the Work. All copies made under this authorization shall bear the copyright notice, if any, shown on the Instruments of Service. The Contractor, Subcontractors, Sub-subcontractors, and material or equipment suppliers may not use the Instruments of Service on other projects or for additions to this Project outside the scope of the Work without the specific written consent of the Owner, Engineer, or his designee and the Engineer, or his designee 's consultants.

§ 1.6 TRANSMISSION OF DATA IN DIGITAL FORM

If the parties intend to transmit Instruments of Service or any other information or documentation in digital form, they shall endeavor to establish necessary protocols governing such transmissions, unless otherwise already provided in the Agreement or the Contract Documents.

ARTICLE 2 OWNER

§ 2.1 GENERAL

§ 2.1.1 The Owner is the person or entity identified as such in the Agreement and is referred to throughout the Contract Documents as if singular in number. The Owner shall designate in writing a representative who shall have express authority to bind the Owner with respect to all matters requiring the Owner's approval or authorization. Except as otherwise provided elsewhere in the Contract Documents, the Engineer, or his designee does not have such authority. The term "Owner" means the Owner or the Owner's authorized representative.

§ 2.2 INFORMATION AND SERVICES REQUIRED OF THE OWNER

§ 2.2.1 The Contractor may request in writing that the Owner provide reasonable evidence that the Owner has made financial arrangements to fulfill the Owner's obligations under the Contract only in the event that: (1) the Owner fails to make payments to the Contractor as the Contract Documents require; (2) a change in the Work materially changes the Contract Sum. The Owner shall furnish such evidence as a condition precedent to commencement or continuation of the Work or the portion of the Work affected by a material change. After the Owner furnishes the evidence, the Owner shall not materially vary such financial arrangements without prior notice to the Contractor.

§ 2.2.2 Except for permits and fees that are the responsibility of the Contractor under the Contract Documents, including those required under Section 3.7.1, the Owner shall secure and pay for necessary approvals, easements, assessments and charges required for construction, use or occupancy of permanent structures or for permanent changes in existing facilities.

§ 2.2.3 If readily available, the Owner shall furnish surveys describing physical characteristics and legal limitations for the site of the Project, and a legal description of the site. The Contractor shall be entitled to rely on the accuracy of information furnished by the Owner but shall exercise proper precautions relating to the safe performance of the Work. The Contractor shall be responsible for requesting and obtaining a utility mark-out.

§ 2.2.4 The Owner shall furnish information or services required of the Owner by the Contract Documents with reasonable promptness. The Owner shall also furnish any other information or services under the Owner's control and relevant to the Contractor's performance of the Work with reasonable promptness after receiving the Contractor's written request for such information or services.

§ 2.2.5 Unless otherwise provided in the Contract Documents, the Owner shall furnish to the Contractor one copy of the Contract Documents for purposes of making reproductions pursuant to Section 1.5.2.

§ 2.3 OWNER'S RIGHT TO STOP THE WORK

If the Contractor fails to correct Work that is not in accordance with the requirements of the Contract Documents as required by Article 12 or fails to carry out Work in accordance with the Contract Documents, the Owner may issue a written order to the Contractor to stop the Work, or any portion thereof, until the cause for such order has been eliminated; however, the right of the Owner to stop the Work shall not give rise to a duty on the part of the Owner to exercise this right for the benefit of the Contractor or any other person or entity, except to the extent required by Section 6. Owner shall in no way be responsible for any delays or claims arising from delays for enforcement of this Section.

§ 2.4 OWNER'S RIGHT TO CARRY OUT THE WORK

If the Contractor defaults or neglects to carry out the Work in accordance with the Contract Documents and fails within a seven-day period after receipt of written notice from the Owner to commence and continue correction of such default or neglect with diligence and promptness, the Owner may, without prejudice to other remedies the Owner may have, correct such deficiencies. In such case an appropriate Change Order shall be issued deducting from payments then or thereafter due the Contractor the reasonable cost of correcting such deficiencies, including Owner's expenses and compensation for the Engineer, or his designee's additional services made necessary by such default, neglect or failure. If payments then or thereafter due the Contractor are not sufficient to cover such amounts, the Contractor shall pay the difference to the Owner.

ARTICLE 3 CONTRACTOR

§ 3.1 GENERAL

§ 3.1.1 The Contractor is the person or entity identified as such in the Agreement and is referred to throughout the Contract Documents as if singular in number. The Contractor shall be lawfully licensed, if required in the jurisdiction where the Project is located and shall maintain as current any approvals or certifications that may be required to perform the Work. The term "Contractor" means the Contractor or the Contractor's authorized representative.

§ 3.1.2 The Contractor shall perform the Work in accordance with the Contract Documents.

§ 3.1.3 The Contractor shall not be relieved of obligations to perform the Work in accordance with the Contract Documents either by activities or duties of the Engineer, or his designee in the Engineer, or his designee's administration of the Contract, or by tests, inspections or approvals required or performed by persons or entities other than the Contractor.

§ 3.2 REVIEW OF CONTRACT DOCUMENTS AND FIELD CONDITIONS BY CONTRACTOR

§ 3.2.1 Execution of the Contract by the Contractor is a representation that the Contractor has visited the site, become generally familiar with local conditions under which the Work is to be performed and correlated personal observations with requirements of the Contract Documents.

§ 3.2.2 Because the Contract Documents are complementary, the Contractor shall, before starting each portion of the Work, carefully study and compare the various Contract Documents relative to that portion of the Work, as well as the information furnished by the Owner pursuant to Section 2.2.3, shall take field measurements of any existing conditions related to that portion of the Work, and shall observe any conditions at the site affecting it. These obligations are for the purpose of facilitating coordination and construction by the Contractor and are not for the purpose of discovering errors, omissions, or inconsistencies in the Contract Documents; however, the Contractor shall promptly report to the Engineer, or his designee any errors, inconsistencies or omissions discovered by or made known to the Contractor as a request for information in such form as the Engineer, or his designee may require. It is recognized that the Contractor's review is made in the Contractor's capacity as a Contractor and not as a licensed design professional, unless otherwise specifically provided in the Contract Documents.

§ 3.2.3 The Contractor is not required to ascertain that the Contract Documents are in accordance with applicable laws, statutes, ordinances, codes, rules and regulations, or lawful orders of public authorities, but the Contractor shall promptly report to the Engineer, or his designee any nonconformity discovered by or made known to the Contractor as a request for information in such form as the Engineer, or his designee may require.

§ 3.2.4 If the Contractor believes that additional cost or time is involved because of clarifications or instructions the Engineer, or his designee issues in response to the Contractor's notices or requests for information pursuant to Sections 3.2.2 or 3.2.3, the Contractor shall make Claims as provided in Article 15. If the Contractor fails to perform the obligations of Sections 3.2.2 or 3.2.3, the Contractor shall pay such costs and damages to the Owner as would have been avoided if the Contractor had performed such obligations. If the Contractor performs those obligations, the Contractor shall not be liable to the Owner or Engineer, or his designee for damages resulting from errors, inconsistencies or omissions in the Contract Documents, for differences between field measurements or conditions and the Contract Documents, or for nonconformities of the Contract Documents to applicable laws, statutes, ordinances, codes, rules and regulations, and lawful orders of public authorities.

§ 3.3 SUPERVISION AND CONSTRUCTION PROCEDURES

§ 3.3.1 The Contractor shall supervise and direct the Work, using the Contractor's best skill and attention. The Contractor shall be solely responsible for, and have control over, construction means, methods, techniques, sequences and procedures and for coordinating all portions of the Work under the Contract, unless the Contract Documents give other specific instructions concerning these matters. If the Contract Documents give specific instructions concerning construction means, methods, techniques, sequences or procedures, the Contractor shall evaluate the jobsite safety thereof and, except as stated below, shall be fully and solely responsible for the jobsite safety of such means, methods, techniques, sequences or procedures. If the Contractor determines that such means, methods, techniques, sequences or procedures may not be safe, the Contractor shall give timely written notice to the Owner and Engineer, or his designee and shall not proceed with that portion of the Work without further written instructions from the Engineer, or his designee. If the Contractor is then instructed to proceed with the required means, methods, techniques, sequences or procedures without acceptance of changes proposed by the Contractor, the Owner shall be solely responsible for any loss or damage arising solely from those Owner-required means, methods, techniques, sequences or procedures.

§ 3.3.2 The Contractor shall be responsible to the Owner for acts and omissions of the Contractor's employees, Subcontractors and their agents and employees, and other persons or entities performing portions of the Work for, or on behalf of, the Contractor or any of its Subcontractors.

§ 3.3.3 The Contractor shall be responsible for inspection of portions of Work already performed to determine that such portions are in proper condition to receive subsequent Work.

§ 3.4 LABOR AND MATERIALS

§ 3.4.1 Unless otherwise provided in the Contract Documents, the Contractor shall provide and pay for labor, materials, equipment, tools, construction equipment and machinery, water, heat, utilities, transportation, and other facilities and services necessary for proper execution and completion of the Work, whether temporary or permanent and whether or not incorporated or to be incorporated in the Work.

§ 3.4.2 Except in the case of minor changes in the Work authorized by the Engineer, or his designee in accordance with Sections 3.12.8 or 7.4, the Contractor may make substitutions only with the consent of the Owner, after

evaluation by the Engineer, or his designee and in accordance with a Change Order or Construction Change Directive.

§ 3.4.3 The Contractor shall enforce strict discipline and good order among the Contractor's employees and other persons carrying out the Work. The Contractor shall not permit employment of unfit persons or persons not properly skilled in tasks assigned to them.

§ 3.5 WARRANTY

The Contractor warrants to the Owner and Engineer, or his designee that materials and equipment furnished under the Contract will be of good quality and new unless the Contract Documents require or permit otherwise. The Contractor further warrants that the Work will conform to the requirements of the Contract Documents and will be free from defects, except for those inherent in the quality of the Work the Contract Documents require or permit. Work, materials, or equipment not conforming to these requirements may be considered defective. The Contractor's warranty excludes remedy for damage or defect caused by abuse, alterations to the Work not executed by the Contractor, improper or insufficient maintenance, improper operation, or normal wear and tear and normal usage. If required by the Engineer, or his designee, the Contractor shall furnish satisfactory evidence as to the kind and quality of materials and equipment. Such warranty shall continue for a period of one (1) year from the date of Substantial Completion of the Work. Under this warranty, the Contractor shall remedy at his expense any such failure for the Work to be conforming to the requirement of the Contract, or any other defect appearing in the Work. In addition, the Contractor shall remedy at his own expense, any damage to Owner's owned, controlled, real or personal property, when that damage is the result of the Contractor's failure to provide conforming Work as it relates to the Contract Documents or any other defect of equipment, material, workmanship or design. The Contractor shall also restore any Work damaged in fulfilling its obligations under the terms of this provision. The Contractor's warranty with respect to the Work repaired or replaced hereunder will run for a period of one (1) year from the date of repair or replacement.

§ 3.6 TAXES

The Contractor shall pay use and similar taxes for the Work provided by the Contractor that are legally enacted when bids are received or negotiations concluded, whether or not yet effective or merely scheduled to go into effect.

§ 3.7 PERMITS, FEES, NOTICES AND COMPLIANCE WITH LAWS

§ 3.7.1 Unless otherwise provided in the Contract Documents, the Contractor shall secure and pay for the building permit as well as for other permits, fees, licenses, and inspections by government agencies necessary for proper execution and completion of the Work that are customarily secured after execution of the Contract and legally required at the time bids are received or negotiations concluded.

§ 3.7.2 The Contractor shall comply with and give notices required by applicable laws, statutes, ordinances, codes, rules and regulations, and lawful orders of public authorities applicable to performance of the Work.

§ 3.7.3 If the Contractor performs Work knowing it to be contrary to applicable laws, statutes, ordinances, codes, rules and regulations, or lawful orders of public authorities, the Contractor shall assume appropriate responsibility for such Work and shall bear the costs attributable to correction.

§ 3.7.4 **Concealed or Unknown Conditions.** If the Contractor encounters conditions at the site that are (1) subsurface or otherwise concealed physical conditions that differ materially from those indicated in the Contract Documents or (2) unknown physical conditions of an unusual nature, that differ materially from those ordinarily found to exist and generally recognized as inherent in construction activities of the character provided for in the Contract Documents, the Contractor shall promptly provide notice to the Owner and the Engineer, or his designee before conditions are disturbed and in no event later than 21 days after first observance of the conditions. The Engineer, or his designee will promptly investigate such conditions and, if the Engineer, or his designee determines that they differ materially and cause an increase or decrease in the Contractor's cost of, or time required for, performance of any part of the Work, will recommend an equitable adjustment in the Contract Sum or Contract Time, or both. If the Engineer, or his designee determines that the conditions at the site are not materially different from those indicated in the Contract Documents and that no change in the terms of the Contract is justified, the Engineer, or his designee shall promptly notify the Owner and Contractor in writing, stating the reasons. If either party disputes the Engineer, or his designee's determination or recommendation, that party may proceed as provided in Article 15.

§ 3.7.5 If, in the course of the Work, the Contractor encounters human remains or recognizes the existence of burial markers, archaeological sites or wetlands not indicated in the Contract Documents, the Contractor shall immediately suspend any operations that would affect them and shall notify the Owner and Engineer, or his designee. Upon receipt of such notice, the Owner shall promptly take any action necessary to obtain governmental authorization required to resume the operations. The Contractor shall continue to suspend such operations until otherwise instructed by the Owner but shall continue with all other operations that do not affect those remains or features. Requests for adjustments in the Contract Sum and Contract Time arising from the existence of such remains or features may be made as provided in Article 15.

§ 3.8 ALLOWANCES

§ 3.8.1 The Contractor shall include in the Contract Sum all allowances stated in the Contract Documents. Items covered by allowances shall be supplied for such amounts and by such persons or entities as the Owner may direct.

§ 3.8.2 Unless otherwise provided in the Contract Documents,

- .1 Allowances shall cover the cost to the Contractor of materials and equipment delivered at the site and all required taxes, less applicable trade discounts;
- .2 Contractor's costs for unloading and handling at the site, labor, installation costs, overhead, profit and other expenses contemplated for stated allowance amounts shall be included in the Contract Sum but not in the allowances; and
- .3 Whenever costs are more than or less than allowances, the Contract Sum shall be adjusted accordingly by Change Order. The amount of the Change Order shall reflect (1) the difference between actual costs and the allowances under Section 3.8.2.1 and (2) changes in Contractor's costs under Section 3.8.2.2. The unused balance of any allowance shall be deducted from the Contract Sum upon completion and acceptance of the Work by Change Order.

§ 3.8.3 Materials and equipment under an allowance shall be selected by the Owner with reasonable promptness.

§ 3.9 SUPERINTENDENT

§ 3.9.1 The Contractor shall employ a competent superintendent and necessary assistants who shall be in attendance at the Project site during performance of the Work. The superintendent shall represent the Contractor, and communications given to the superintendent shall be as binding as if given to the Contractor.

§ 3.9.2 The Contractor, as soon as practicable after award of the Contract, shall furnish in writing to the Owner through the Engineer, or his designee the name and qualifications of a proposed superintendent. The Engineer, or his designee may reply within 14 days to the Contractor in writing stating (1) whether the Owner or the Engineer, or his designee has reasonable objection to the proposed superintendent or (2) that the Engineer, or his designee requires additional time to review. Failure of the Engineer, or his designee to reply within the 14 day period shall constitute notice of no reasonable objection.

§ 3.9.3 The Contractor shall not employ a proposed superintendent to whom the Owner or Engineer, or his designee has made reasonable and timely objection. The Contractor shall not change the superintendent without the Owner's consent, which shall not unreasonably be withheld or delayed.

§ 3.10 CONTRACTOR'S CONSTRUCTION SCHEDULES

§ 3.10.1 The Contractor, promptly after being awarded the Contract, shall prepare and submit for the Owner's and Engineer, or his designee's information a Contractor's construction schedule for the Work. The schedule shall not exceed time limits current under the Contract Documents, shall be revised at appropriate intervals as required by the conditions of the Work and Project, shall be related to the entire Project to the extent required by the Contract Documents, and shall provide for expeditious and practicable execution of the Work.

§ 3.10.2 The Contractor shall prepare a submittal schedule, promptly after being awarded the Contract and thereafter as necessary to maintain a current submittal schedule, and shall submit the schedule(s) for the Engineer, or his designee's approval. The Engineer, or his designee's approval shall not unreasonably be delayed or withheld. The submittal schedule shall (1) be coordinated with the Contractor's construction schedule, and (2) allow the Engineer, or his designee reasonable time to review submittals. If the Contractor fails to submit a submittal

schedule, the Contractor shall not be entitled to any increase in Contract Sum or extension of Contract Time based on the time required for review of submittals.

§ 3.10.3 The Contractor shall perform the Work in general accordance with the most recent schedules submitted to the Owner and Engineer, or his designee .

§3.10.4 Should the Contractor responsible for the scheduling requirements of Article 3 herein fail to comply with said scheduling requirements, said failure shall result in the following:

- 1 all claims resulting from the Contractor's failure to prepare or submit a schedule shall be the Contractor's responsibility;
- 2 shall constitute an act of default and a substantial breach of the Contract giving the Owner remedies under the Contract Documents; and
- 3 the Owner shall have the right to withhold any payments until the Contractor complies with the scheduling requirements of Article 3 herein.

§3.10.5 In the event of a Five Prime Contract, the General Contractor shall be responsible for the preparation and submittal of the schedule.

§ 3.11 DOCUMENTS AND SAMPLES AT THE SITE

The Contractor shall maintain at the site for the Owner one copy of the Drawings, Specifications, Addenda, Change Orders and other Modifications, in good order and marked currently to indicate field changes and selections made during construction, and one copy of approved Shop Drawings, Product Data, Samples and similar required submittals. These shall be available to the Engineer, or his designee and shall be delivered to the Engineer, or his designee for submittal to the Owner upon completion of the Work as a record of the Work as constructed.

§ 3.12 SHOP DRAWINGS, PRODUCT DATA AND SAMPLES

§ 3.12.1 Shop Drawings are drawings, diagrams, schedules and other data specially prepared for the Work by the Contractor or a Subcontractor, Sub-subcontractor, manufacturer, supplier or distributor to illustrate some portion of the Work.

§ 3.12.2 Product Data are illustrations, standard schedules, performance charts, instructions, brochures, diagrams and other information furnished by the Contractor to illustrate materials or equipment for some portion of the Work.

§ 3.12.3 Samples are physical examples that illustrate materials, equipment or workmanship and establish standards by which the Work will be judged.

§ 3.12.4 Shop Drawings, Product Data, Samples and similar submittals are not Contract Documents. Their purpose is to demonstrate the way by which the Contractor proposes to conform to the information given and the design concept expressed in the Contract Documents for those portions of the Work for which the Contract Documents require submittals. Review by the Engineer, or his designee is subject to the limitations of Section 4.2.7. Informational submittals upon which the Engineer, or his designee is not expected to take responsive action may be so identified in the Contract Documents. Submittals that are not required by the Contract Documents may be returned by the Engineer, or his designee without action.

§ 3.12.5 The Contractor shall review for compliance with the Contract Documents, approve and submit to the Engineer, or his designee Shop Drawings, Product Data, Samples and similar submittals required by the Contract Documents in accordance with the submittal schedule approved by the Engineer, or his designee or, in the absence of an approved submittal schedule, with reasonable promptness and in such sequence as to cause no delay in the Work or in the activities of the Owner or of separate contractors.

§ 3.12.6 By submitting Shop Drawings, Product Data, Samples and similar submittals, the Contractor represents to the Owner and Engineer, or his designee that the Contractor has (1) reviewed and approved them, (2) determined and verified materials, field measurements and field construction criteria related thereto, or will do so and (3) checked and coordinated the information contained within such submittals with the requirements of the Work and of the Contract Documents.

§ 3.12.7 The Contractor shall perform no portion of the Work for which the Contract Documents require submittal and review of Shop Drawings, Product Data, Samples or similar submittals until the respective submittal has been approved by the Engineer, or his designee .

§ 3.12.8 The Work shall be in accordance with approved submittals except that the Contractor shall not be relieved of responsibility for deviations from requirements of the Contract Documents by the Engineer or his designee 's approval of Shop Drawings, Product Data, Samples or similar submittals unless the Contractor has specifically informed the Engineer, or his designee in writing of such deviation at the time of submittal and (1) the Engineer, or his designee has given written approval to the specific deviation as a minor change in the Work, or (2) a Change Order or Construction Change Directive has been issued authorizing the deviation. The Contractor shall not be relieved of responsibility for errors or omissions in Shop Drawings, Product Data, Samples or similar submittals by the Engineer, or his designee 's approval thereof.

§ 3.12.9 The Contractor shall direct specific attention, in writing or on resubmitted Shop Drawings, Product Data, Samples or similar submittals, to revisions other than those requested by the Engineer, or his designee on previous submittals. In the absence of such written notice, the Engineer, or his designee 's approval of a resubmission shall not apply to such revisions.

§ 3.12.10 The Contractor shall not be required to provide professional services that constitute the practice of Engineer, or his designee ure or engineering unless such services are specifically required by the Contract Documents for a portion of the Work or unless the Contractor needs to provide such services in order to carry out the Contractor's responsibilities for construction means, methods, techniques, sequences and procedures. The Contractor shall not be required to provide professional services in violation of applicable law. If professional design services or certifications by a design professional related to systems, materials or equipment are specifically required of the Contractor by the Contract Documents, the Owner and the Engineer, or his designee will specify all performance and design criteria that such services must satisfy. The Contractor shall cause such services or certifications to be provided by a properly licensed design professional, whose signature and seal shall appear on all drawings, calculations, specifications, certifications, Shop Drawings and other submittals prepared by such professional. Shop Drawings and other submittals related to the Work designed or certified by such professional, if prepared by others, shall bear such professional's written approval when submitted to the Engineer or his designee . The Owner and the Engineer, or his designee shall be entitled to rely upon the adequacy, accuracy and completeness of the services, certifications and approvals performed or provided by such design professionals, provided the Owner and Engineer, or his designee have specified to the Contractor all performance and design criteria that such services must satisfy. Pursuant to this Section 3.12.10, the Engineer, or his designee will review, approve or take other appropriate action on submittals only for the limited purpose of checking for conformance with information given and the design concept expressed in the Contract Documents. The Contractor shall not be responsible for the adequacy of the performance and design criteria specified in the Contract Documents.

§ 3.13 USE OF SITE

§ 3.13.1 The Contractor shall confine operations at the site to areas permitted by applicable laws, statutes, ordinances, codes, rules and regulations, and lawful orders of public authorities and the Contract Documents and shall not unreasonably encumber the site with materials or equipment.

§ 3.13.2 The Contractor shall coordinate the Contractor's operations with, and secure the approval of, the Owner before using any portion of the Site.

§ 3.13.3 The Contractor shall store its apparatuses, materials, supplies, and equipment in such orderly fashion at the Site of the Work, if permitted, as will not unduly interfere with the progress of the Work or ongoing operations. The Contractor shall provide protective fencing around the designated storage areas.

§ 3.13.4 The Contractor shall see that stockpiles of materials and storage of equipment are kept to a minimum and neatly stored where directed by the Owner and the Engineer, or his designee .

§ 3.13.5 If the Work is to be executed in areas occupied by the Owner, the Contractor shall inform the Owner in advance of the areas scheduled to be worked on, so that the Owner's personnel may make proper preparations to protect equipment and records.

§3.13.6 The Contractor understands that some or all the Work of the Contract may be performed while the facilities are occupied by personnel, and accordingly shall make all reasonable and necessary provisions to ensure that the contract Work will be of minimal disruption to the environment.

§3.13.7 Materials and equipment that are to be used only directly in the Work, shall be brought to and stored on the Project site by the Contractor. After equipment is no longer required for the Work, it shall be promptly removed from the Project Site. Protection of construction materials and equipment stored at the Project Site from weather, theft, damage and all other adversity is solely the Contractor's responsibility. The Contractor shall bear the responsibility to replace all such materials that may be lost, damaged, or stolen at its expense, whether such materials or equipment have been entirely or partially paid for by the Owner.

§3.13.8 The Contractor and any entity for whom the Contractor is responsibility, shall not erect any sign on the Project Site without the prior written consent of the Owner, which may be withheld in the sole discretion of the Owner.

§3.13.9 Contractor shall ensure that the Work is performed at all times in a manner that affords reasonable access, both vehicular and pedestrian, to the Site of the Work and all adjacent areas. The Work shall be performed, to the fullest extent reasonably possible, in such a manner that public areas adjacent to the Site of the Work shall be free from all debris, building materials, and equipment likely to cause hazardous conditions.

§3.13.10 Without prior approval of the Owner, the Contractor shall not permit any workers to use any existing facilities at the Project Site, including, without limitation, the lavatories, toilets, entrances, and parking areas, other than those designated by the Owner. Without limitation of any other provision of the Contract Documents, the Contractor shall use its best efforts to comply with all rules and regulations promulgated by the Owner in connection with the use and occupancy of the Project Site and the Building, as amended from time to time. The Contractor shall immediately notify the Owner in writing, if during the performance of the Work, the Contractor finds compliance with any portion of such rules and regulations to be impracticable. This notification shall set forth the problems of such compliance and shall suggest alternatives through which the same results intended by such portions of the rules and regulations can be achieved. The Owner may, in the Owner's sole discretion, adopt such suggestions, develop new alternatives or require compliance with the existing requirements of the rules and regulations. The Contractor shall also comply with all insurance requirements and collective bargaining agreements applicable to use and occupancy of the Project Site and the Building.

§ 3.14 CUTTING AND PATCHING

§ 3.14.1 The Contractor shall be responsible for cutting, fitting or patching required to complete the Work or to make its parts fit together properly. All areas requiring cutting, fitting and patching shall be restored to the condition existing prior to the cutting, fitting and patching, unless otherwise required by the Contract Documents. Any costs incurred by the Onwer for defective cutting or patching shall be borne by the Contractor responsible therefore.

§ 3.14.2 The Contractor shall not damage or endanger a portion of the Work or fully or partially completed construction of the Owner or separate contractors by cutting, patching or otherwise altering such construction, or by excavation. The Contractor shall not cut or otherwise alter such construction by the Owner or a separate Contractor except with written consent of the Owner and of such separate Contractor; such consent shall not be unreasonably withheld. The Contractor shall not unreasonably withhold from the Owner or a separate Contractor the Contractor's consent to cutting or otherwise altering the Work.

§ 3.15 CLEANING UP

§ 3.15.1 The Contractor shall keep the premises and surrounding area free from accumulation of waste materials or rubbish caused by operations under the Contract. At completion of the Work, the Contractor shall remove waste materials, rubbish, the Contractor's tools, construction equipment, machinery and surplus materials from and about the Project.

§ 3.15.2 If the Contractor fails to clean up as provided in the Contract Documents, the Owner may do so and Owner shall be entitled to reimbursement from the Contractor, or shall be entitled to reduce the Contract Amount in an amount equal to the Owner's cost to clean up.

§3.15.3 The Contractor shall, on a daily basis, clean debris resulting from its Work, and protect construction in progress and maintain adjoining materials in place during handling and installation, and provide protective covering where required to assure protection from damage or deterioration until Substantial Completion.

§3.15.4 The Contractor shall clean and provide maintenance on completed construction, after installation, as frequently as necessary through the remainder of the construction period.

§3.15.5 The Contractor shall supervise its construction operations to assure that no part of the construction, completed or in progress, is subject to harmful, dangerous, damaging, or otherwise deleterious exposure during the construction period. The term "clean" shall include the removal of debris from the work area to dumpsters furnished by the Prime General Work Contractor or the Contractor for Single Overall Contract Work, whichever contracting method shall apply.

§ 3.16 ACCESS TO WORK

The Contractor shall provide the Owner and Engineer, or his designee access to the Work in preparation and progress wherever located.

§ 3.17 ROYALTIES, PATENTS AND COPYRIGHTS

The Contractor shall pay all royalties and license fees. The Contractor shall defend suits or claims for infringement of copyrights and patent rights and shall hold the Owner and Engineer, or his designee harmless from loss on account thereof, but shall not be responsible for such defense or loss when a particular design, process or product of a particular manufacturer or manufacturers is required by the Contract Documents, or where the copyright violations are contained in Drawings, Specifications or other documents prepared by the Owner or Engineer, or his designee. However, if the Contractor has reason to believe that the required design, process or product is an infringement of a copyright or a patent, the Contractor shall be responsible for such loss unless such information is promptly furnished to the Engineer, or his designee.

§ 3.18 INDEMNIFICATION

§ 3.18.1 The County of Union requires all bidders to accept the following indemnification requirements in the event the County accepts their bid. The Contract awarded by the County to the successful bidder will contain the following provision:

"To the fullest extent permitted by law the Contractor shall indemnify and hold harmless the Owner and Owner's consultants, agents, representatives, and employees from and against any and all claims, damages, losses, costs, and expenses, including, but not limited to attorney's fees, legal costs and legal expenses arising out of or resulting from the performance of the Contractor's work under this contract, provided that such claim, damage, loss, cost or expense is attributable to bodily injury, sickness, disease or death, or to injury to or destruction of tangible property (other than work itself) caused or alleged to be caused by the negligent acts, negligent omissions, and/or fault of the Contractor, anyone directly or indirectly employed or retained by the Contractor, or anyone for whose acts the Contractor may be liable regardless of whether caused in part by the negligent act or omission of a party indemnified hereunder provided it is not caused by the sole negligence of a party indemnified hereunder. Contractor shall further indemnify and hold harmless the Owner and the Owner's consultants, agents, representative, and employees from and against any and all claims, damages, losses, costs, and expenses, including, but not limited to attorneys' fees, legal costs and legal expenses, arising out of or resulting from performance of the work, provided that such claims, damage, loss, cost, or expense is attributable to bodily injury, sickness, disease or death, or to injury to destruction of tangible property (other than work itself) caused or alleged to be caused by the negligent acts, negligent omissions, and/or fault of the Owner or the Owner's consultants, agents, representatives, or employees and arises out of this project and provided such claim, damage, loss, cost, or expense is not caused by the sole negligence of a party indemnified hereunder."

§ 3.18.2 In claims against any person or entity indemnified under this Section 3.18 by an employee of the Contractor, a Subcontractor, anyone directly or indirectly employed by them or anyone for whose acts they may be liable, the indemnification obligation under Section 3.18.1 shall not be limited by a limitation on amount or type of damages, compensation or benefits payable by or for the Contractor or a Subcontractor under workers' compensation acts, disability benefit acts or other employee benefit acts.

ARTICLE 4 ENGINEER, OR HIS DESIGNEE OR ENGINEER

§ 4.1 GENERAL

§ 4.1.1 The Owner shall retain an Engineer, or his designee lawfully licensed to practice Engineer, or his designee in the jurisdiction where the Project is located. That person or entity is identified as the Engineer, or his designee in the Agreement and is referred to throughout the Contract Documents as if singular in number.

§ 4.1.2 Duties, responsibilities and limitations of authority of the Engineer, or his designee as set forth in the Contract Documents shall not be restricted, modified or extended without written consent of the Owner, Contractor and Engineer, or his designee. Consent shall not be unreasonably withheld.

§ 4.2 ADMINISTRATION OF THE CONTRACT

§ 4.2.1 The Engineer, or his designee will provide administration of the Contract as set forth in its respective Agreements with the Owner and as described in the Contract Documents.

§ 4.2.2 The Engineer, or his designee will visit the site at intervals appropriate to the stage of construction, or as otherwise agreed with the Owner, to become generally familiar with the progress and quality of the portion of the Work completed, and to determine in general if the Work observed is being performed in a manner indicating that the Work, when fully completed, will be in accordance with the Contract Documents.

§ 4.2.3 On the basis of the site visits, the Engineer, or his designee will keep the Owner reasonably informed about the progress and quality of the portion of the Work completed, and report to the Owner (1) known deviations from the Contract Documents and from the most recent construction schedule submitted by the Contractor, and (2) defects and deficiencies observed in the Work.

§ 4.2.4 COMMUNICATIONS FACILITATING CONTRACT ADMINISTRATION

Except as otherwise provided in the Contract Documents or when direct communications have been specially authorized, the Owner and Contractor shall endeavor to communicate with each other through the Engineer, or his designee about matters arising out of or relating to the Contract. Communications by and with the Engineer, or his designee's consultants shall be through the Engineer, or his designee. Communications by and with Subcontractors and material suppliers shall be through the Contractor. Communications by and with separate contractors shall be through the Owner.

§ 4.2.5 Based on the Engineer, or his designee's evaluations of the Contractor's Applications for Payment, the Engineer, or his designee will review and certify the amounts due the Contractor and will issue Certificates for Payment in such amounts.

§ 4.2.6 The Engineer, or his designee has authority to reject Work that does not conform to the Contract Documents. Whenever the Engineer, or his designee considers it necessary or advisable, the Engineer, or his designee will have authority to require inspection or testing of the Work in accordance with Sections 13.5.2 and 13.5.3, whether or not such Work is fabricated, installed or completed. However, neither this authority of the Engineer, or his designee nor a decision made in good faith either to exercise or not to exercise such authority shall give rise to a duty or responsibility of the Engineer, or his designee to the Contractor, Subcontractors, material and equipment suppliers, their agents or employees, or other persons or entities performing portions of the Work.

§ 4.2.7 The Engineer, or his designee will review and approve, or take other appropriate action upon, the Contractor's submittals such as Shop Drawings, Product Data and Samples, but only for the limited purpose of checking for conformance with information given and the design concept expressed in the Contract Documents. The Engineer, or his designee's action will be taken in accordance with the submittal schedule approved by the Engineer, or his designee or, in the absence of an approved submittal schedule, with reasonable promptness while allowing sufficient time in the Engineer, or his designee's professional judgment to permit adequate review. Review of such submittals is not conducted for the purpose of determining the accuracy and completeness of other details such as dimensions and quantities, or for substantiating instructions for installation or performance of equipment or systems, all of which remain the responsibility of the Contractor as required by the Contract Documents. The Engineer, or his designee's review of the Contractor's submittals shall not relieve the Contractor of the obligations under Sections 3.3, 3.5 and 3.12. The Engineer, or his designee's review shall not constitute

approval of safety precautions or, unless otherwise specifically stated by the Engineer, or his designee, of any construction means, methods, techniques, sequences or procedures. The Engineer, or his designee's approval of a specific item shall not indicate approval of an assembly of which the item is a component.

§ 4.2.8 The Engineer, or his designee will prepare Change Orders and Construction Change Directives, and may authorize minor changes in the Work as provided in Section 7. The Engineer, or his designee will investigate and make determinations and recommendations regarding concealed and unknown conditions as provided in Section 3.7.4.

§ 4.2.9 The Engineer, or his designee will conduct inspections to determine the date or dates of Substantial Completion and the date of final completion; issue Certificates of Substantial Completion pursuant to Section 9.8; receive and forward to the Owner, for the Owner's review and records, written warranties and related documents required by the Contract and assembled by the Contractor pursuant to Section 9.10; and issue a final Certificate for Payment pursuant to Section 9.10.

§ 4.2.10 If the Owner and Engineer, or his designee agree, the Engineer, or his designee will provide one or more project representatives to assist in carrying out the Engineer, or his designee's responsibilities at the site. The duties, responsibilities and limitations of authority of such project representatives shall be as set forth in the Owner's Agreement with the Engineer, or his designee.

§ 4.2.11 The Engineer, or his designee will interpret and decide matters concerning performance under, and requirements of, the Contract Documents on written request of either the Owner or Contractor. The Engineer, or his designee's response to such requests will be made in writing within any time limits agreed upon or otherwise with reasonable promptness.

§ 4.2.12 Interpretations and decisions of the Engineer, or his designee will be consistent with the intent of, and reasonably inferable from, the Contract Documents and will be in writing or in the form of drawings. When making such interpretations and decisions, the Engineer, or his designee will endeavor to secure faithful performance by both Owner and Contractor and will not show partiality.

§ 4.2.13 The Engineer, or his designee will review and respond to requests for information about the Contract Documents. The Engineer, or his designee's response to such requests will be made in writing within any time limits agreed upon or otherwise with reasonable promptness. If appropriate, the Engineer, or his designee will prepare and issue supplemental Drawings and Specifications in response to the requests for information.

ARTICLE 5 SUBCONTRACTORS

§ 5.1 DEFINITIONS

§ 5.1.1 A Subcontractor is a person or entity who has a direct contract with the Contractor to perform a portion of the Work at the site. The term "Subcontractor" is referred to throughout the Contract Documents as if singular in number and means a Subcontractor or an authorized representative of the Subcontractor. The term "Subcontractor" does not include a separate Contractor or subcontractors of a separate Contractor.

§ 5.1.2 A Sub-subcontractor is a person or entity who has a direct or indirect contract with a Subcontractor to perform a portion of the Work at the site. The term "Sub-subcontractor" is referred to throughout the Contract Documents as if singular in number and means a Sub-subcontractor or an authorized representative of the Sub-subcontractor.

§ 5.2 AWARD OF SUBCONTRACTS AND OTHER CONTRACTS FOR PORTIONS OF THE WORK

§ 5.2.1 Identification of Subcontractors required by N.J.S.A. 40A:11-16 shall be provided with the bid submission in accordance with the requirements of that statute. Names of persons or entities for any Subcontractor not covered by N.J.S.A. 18A-18 shall be furnished within thirty (30) thirty days of notification of Award of Contract. The Engineer, or his designee will notify the Contractor in writing if the Owner or Engineer, or his designee, after due investigation, has reasonable objection to any such proposed person or entity. The list of proposed Subcontractors shall include a description of the materials and equipment each proposes to furnish and install in the Work. The description shall be insufficient detail to allow the Engineer, or his designee to determine general conformance to Contract requirements. Approval of the submittals as required under this Article shall not relieve the Contractor from conformance to Contract requirements.

§5.2.2 Subcontractors shall comply with the statutory requirements of N.J.S.A. 34:11-56.25 and N.J.S.A. 34:11-56.48. Any subcontractors who fail to comply with those statutory provisions shall be rejected.

§5.2.3 Written confirmation of award of each major subcontract shall be submitted to the Owner by the Contractor, in form subject to his approval, within seven (7) days after receipt of Owner's approval of proposed Subcontractor list as provided under this Article. Every subcontract shall be in writing, shall be submitted to Owner for review and approval prior to execution, and shall specifically provide that the Owner is an intended third (3rd) party beneficiary of such subcontract.

§ 5.2.4 The Contractor shall not contract with a proposed person or entity to whom the Owner or Engineer, or his designee has made reasonable and timely objection. The Contractor shall not be required to contract with anyone to whom the Contractor has made reasonable objection.

§ 5.2.5 If the Owner or Engineer, or his designee has reasonable objection to a person or entity proposed by the Contractor, the Contractor shall propose another to whom the Owner or Engineer, or his designee has no reasonable objection. If the proposed but rejected Subcontractor was reasonably capable of performing the Work, the Contract Sum and Contract Time shall be increased or decreased by the difference, if any, occasioned by such change, and an appropriate Change Order shall be issued before commencement of the substitute Subcontractor's Work. However, no increase in the Contract Sum or Contract Time shall be allowed for such change unless the Contractor has acted promptly and responsively in submitting names as required.

§ 5.2.6 The Contractor shall not substitute a Subcontractor, person or entity previously selected if the Owner or Engineer, or his designee makes reasonable objection to such substitution.

§ 5.3 SUBCONTRACTUAL RELATIONS

§5.3.1 By appropriate agreement, written where legally required for validity, the Contractor shall require each Subcontractor, to the extent of the Work to be performed by the Subcontractor, to be bound to the Contractor by terms of the Contract Documents, and to assume toward the Contractor all the obligations and responsibilities, including the responsibility for safety of the Subcontractor's Work, which the Contractor, by these Documents, assumes toward the Owner and Engineer, or his designee. Each subcontract agreement shall preserve and protect the rights of the Owner and Engineer, or his designee under the Contract Documents and at law. No Subcontract shall diminish in any way any rights or benefits conferred upon the Owner by these Contract Documents. The Contractor shall make all Contract Documents available to the Subcontractors.

§5.3.2 Where the Contractor sublets portions of the Work, the entire responsibility for the subdividing of Work rests with the Contractor. The Owner and the Engineer, or his designee are not responsible for the manner of the subdivision of the Work, nor will they enter into or settle disagreements or disputes between Contractor and Subcontractors. The Contractor is, and will be held, responsible for the proper execution of the Work of all Subcontractors.

§ 5.4 CONTINGENT ASSIGNMENT OF SUBCONTRACTS

§ 5.4.1 Each subcontract agreement for a portion of the Work is assigned by the Contractor to the Owner, provided that

- 1 assignment is effective only after termination of the Contract by the Owner for cause pursuant to Section 14.2 and only for those subcontract agreements that the Owner accepts by notifying the Subcontractor and Contractor in writing.

§ 5.4.2 Upon such assignment to the Owner under this Section 5.4, the Owner may further assign the subcontract to a successor Contractor or other entity.

ARTICLE 6 CONSTRUCTION BY OWNER OR BY SEPARATE CONTRACTORS

§ 6.1 OWNER'S RIGHT TO PERFORM CONSTRUCTION AND TO AWARD SEPARATE CONTRACTS

§ 6.1.1 The Owner reserves the right to perform construction or operations related to the Project with the Owner's own forces, and to award separate contracts in connection with other portions of the Project or other construction or operations on the site.

§ 6.1.2 The Owner shall provide for coordination of the activities of the Owner's own forces and of each separate Contractor with the Work of the Contractor, who shall cooperate with them. The Contractor shall participate with other separate contractors and the Owner in reviewing their construction schedules. The Contractor shall make any revisions to the construction schedule deemed necessary after a joint review and mutual agreement. The construction schedules shall then constitute the schedules to be used by the Contractor, separate contractors and the Owner until subsequently revised.

§ 6.2 MUTUAL RESPONSIBILITY

§ 6.2.1 The Contractor shall afford the Owner and separate contractors reasonable opportunity for introduction and storage of their materials and equipment and performance of their activities, and shall connect and coordinate the Contractor's construction and operations with theirs as required by the Contract Documents.

§ 6.2.2 If part of the Contractor's Work depends for proper execution or results upon construction or operations by the Owner or a separate Contractor, the Contractor shall, prior to proceeding with that portion of the Work, promptly report to the Engineer, or his designee apparent discrepancies or defects in such other construction that would render it unsuitable for such proper execution and results. Failure of the Contractor so to report shall constitute an acknowledgment that the Owner's or separate Contractor's completed or partially completed construction is fit and proper to receive the Contractor's Work, except as to defects not then reasonably discoverable.

§ 6.2.3 The Contractor shall reimburse the Owner for costs the Owner incurs that are payable to a separate Contractor because of the Contractor's delays, improperly timed activities or defective construction. The Owner shall be responsible to the Contractor for costs the Contractor incurs because of a separate Contractor's delays, improperly timed activities, damage to the Work or defective construction.

§ 6.2.4 The Contractor shall promptly remedy damage the Contractor wrongfully causes to completed or partially completed construction or to property of the Owner or separate contractors as provided in Section 10.2.5.

§ 6.2.4.1 Should the Contractor cause damage to the Work or property of any separate Contractor on the Project, the Contractor shall promptly settle with such other Contractor by agreement, or otherwise resolve the dispute. If such separate Contractor institutes any legal proceeding against the Owner on account of any damage alleged to have been so sustained, the Contractor shall, indemnify, defend, or bear the cost of defense as the Owner shall in its own discretion determine, and hold the Owner's harmless. Said Indemnification shall be governed by Section 13, Page G7 of the Instructions to Bidders.

§ 6.2.5 The Owner and each separate Contractor shall have the same responsibilities for cutting and patching as are described for the Contractor in Section 3.14.

§ 6.3 OWNER'S RIGHT TO CLEAN UP

If a dispute arises among the Contractor, separate contractors and the Owner as to the responsibility under their respective contracts for maintaining the premises and surrounding area free from waste materials and rubbish, the Owner may clean up and the Engineer, or his designee will allocate the cost among those responsible, which amounts the Owner shall be entitled to reduce the Contract Amounts of the various contracts of those responsible.

ARTICLE 7 CHANGES IN THE WORK

§ 7.1 GENERAL

§ 7.1.1 Changes in the Work may be accomplished after execution of the Contract, and without invalidating the Contract, by Change Order, Construction Change Directive or order for a minor change in the Work, subject to the limitations stated in this Article 7 and elsewhere in the Contract Documents. Change Orders and Construction Change Directives shall be subject to and processed in accordance with N.J.A.C. 6A:23-7 and N.J.A.C. 6A:26-4.9, where applicable.

§ 7.1.2 A Change Order shall be based upon agreement among the Owner, Contractor and Engineer, or his designee; a Construction Change Directive requires a written agreement by the Owner and Engineer, or his designee and may or may not be agreed to by the Contractor; an order for a minor change in the Work which does not extend the Contract Time, increase the Contract Sum or change the Project Scope may be issued by the Engineer, or his designee alone.

§ 7.1.3 Changes in the Work shall be performed under applicable provisions of the Contract Documents, and the Contractor shall proceed promptly, unless otherwise provided in the Change Order, Construction Change Directive or order for a minor change in the Work.

§ 7.1.4 In order to facilitate checking of quotations for extras or credits, all proposals shall be accompanied by a complete itemization of costs including labor, materials and subcontracts. Labor and materials shall be itemized in the manner prescribed above. Where major cost items are subcontracts, they shall be itemized also. In no case will a change be approved without such itemization.

§ 7.2 CHANGE ORDERS

§ 7.2.1 A Change Order is a written instrument prepared by the Engineer, or his designee and signed by the Owner, Contractor and Engineer, or his designee stating their agreement upon all of the following:

- .1 The change in the Work;
- .2 The amount of the adjustment, if any, in the Contract Sum; and
- .3 The extent of the adjustment, if any, in the Contract Time.

A Change Order shall not require consent of the Owner if the Owner has provided an allowance for such a change.

§ 7.2.2 Methods used in determining adjustments to the Contract Sum shall be those listed in Section 7.3.3.

§ 7.2.3 Agreement on any Change Order shall constitute a final settlement of all matters relating to the change in the Work that is the subject of the Change Order, including, but not limited to, all direct and indirect costs associated with such change, and any and all adjustments to the Contract Sum and the construction schedule. In the event a Change Order increases the Contract Sum, Contractor shall include the Work covered by such Change Orders in Applications for Payment as if such Work were originally part of the Contract Documents.

§ 7.3 CONSTRUCTION CHANGE DIRECTIVES

§ 7.3.1 A Construction Change Directive is a written order prepared by the Engineer, or his designee and signed by the Owner and Engineer, or his designee, directing a change in the Work prior to agreement on adjustment, if any, in the Contract Sum or Contract Time, or both. A Construction Change Directive shall not require the Agreement of the Engineer, or his designee if the Owner specifically waives their consent in writing. The Owner may by Construction Change Directive, without invalidating the Contract, order changes in the Work within the general scope of the Contract consisting of additions, deletions or other revisions, the Contract Sum and Contract Time being adjusted accordingly.

§ 7.3.2 A Construction Change Directive shall be used in the absence of total agreement on the terms of a Change Order.

§ 7.3.3 If the Construction Change Directive provides for an adjustment to the Contract Sum, the adjustment shall be based on one of the following methods:

- .1 Mutual acceptance of a lump sum properly itemized and supported by sufficient substantiating data to permit evaluation;
- .2 Unit prices stated in the Contract Documents or subsequently agreed upon;
- .3 Cost to be determined in a manner agreed upon by the parties and a mutually acceptable fixed or percentage fee; or
- .4 As provided in Section 7.3.6.

§ 7.3.4 Upon receipt of a Construction Change Directive, the Contractor shall promptly proceed with the change in the Work involved and advise the Engineer, or his designee of the Contractor's agreement or disagreement with the method, if any, provided in the Construction Change Directive for determining the proposed adjustment in the Contract Sum or Contract Time. The Contractor's failure to comply with a Construction Change Directive shall constitute an incident of default and cause for termination by the Owner.

§ 7.3.5 A Construction Change Directive signed by the Contractor indicates the Contractor's agreement therewith, including adjustment in Contract Sum and Contract Time or the method for determining them. Such agreement shall be effective immediately and shall be recorded as a Change Order.

§ 7.3.6 If the Contractor does not respond promptly or disagrees with the method for adjustment in the Contract Sum, the Engineer, or his designee shall determine the method and the adjustment on the basis of reasonable expenditures and savings of those performing the Work attributable to the change, including, in case of an increase in the Contract Sum, an amount for overhead and profit as set forth in the Agreement, or if no such amount is set forth in the Agreement, a reasonable amount. In such case, and also under Section 7.3.3.3, the Contractor shall keep and present, in such form as the Engineer, or his designee may prescribe, an itemized accounting together with appropriate supporting data. Unless otherwise provided in the Contract Documents, costs for the purposes of this Section 7.3.6 shall be limited to the following:

- .1 Costs of labor, including social security, old age and unemployment insurance, fringe benefits required by agreement or custom, and workers' compensation insurance;
- .2 Costs of materials, supplies and equipment, including cost of transportation, whether incorporated or consumed;
- .3 Rental costs of machinery and equipment, exclusive of hand tools, whether rented from the Contractor or others; and
- .4 Costs of premiums for all bonds and insurance, permit fees, and sales, use or similar taxes related to the Work.

§ 7.3.7 The amount of credit to be allowed by the Contractor to the Owner for a deletion or change that results in a net decrease in the Contract Sum shall be actual net cost as confirmed by the Engineer, or his designee. When both additions and credits covering related Work or substitutions are involved in a change, the allowance for overhead and profit shall be figured on the basis of net increase, if any, with respect to that change.

§ 7.3.8 Pending final determination of the total cost of a Construction Change Directive to the Owner, the Contractor may request payment for Work completed under the Construction Change Directive in Applications for Payment. The Engineer, or his designee will make an interim determination for purposes of monthly certification for payment for those costs and certify for payment the amount that the Engineer, or his designee determines, in the Engineer, or his designee's professional judgment, to be reasonably justified. The Engineer, or his designee's interim determination of cost shall adjust the Contract Sum on the same basis as a Change Order, subject to the right of either party to disagree and assert a Claim in accordance with Article 15.

§ 7.3.9 When the Owner and Contractor agree with a determination made by the Engineer, or his designee concerning the adjustments in the Contract Sum and Contract Time, or otherwise reach agreement upon the adjustments, such agreement shall be effective immediately and the Engineer, or his designee will prepare a Change Order. Change Orders may be issued for all or any part of a Construction Change Directive.

§ 7.3.10 In subparagraphs 7.3.3 and 7.3.6, the allowance for overhead and profit combined shall be based upon the following schedule:

- .1 For the Contractor, for work performed by his own forces, 10% of cost.
- .2 For each Subcontractor, for the work performed by his own forces, 10% of cost.
- .3 For the Contractor, for work performed by a subcontractor, 5% of cost.

§ 7.3.11 Lump sum quotations for changes in the Work will not be accepted. Proposals shall be completely itemized and broken down. They shall be accompanied by such supporting data as the Engineer, or his designee may require, such as copies of subcontractor's or vendor's quotations, quantity take-off sheets, or other similar information.

§ 7.4 MINOR CHANGES IN THE WORK

The Engineer, or his designee has authority to order minor changes in the Work not involving adjustment in the Contract Sum or extension of the Contract Time and not inconsistent with the intent of the Contract Documents. Such changes will be effected by written order signed by the Engineer, or his designee and shall be binding on the Owner and Contractor. The Contractor shall carry out such written orders promptly.

ARTICLE 8 TIME

§ 8.1 DEFINITIONS

§ 8.1.1 Unless otherwise provided, Contract Time is the period of time, including authorized adjustments, allotted in the Contract Documents for Substantial Completion of the Work and services as required by the Contract

Documents, Substantial Completion of the Work shall be accomplished within the period of consecutive calendar days (or by the date), as stated in the Agreement, plus any authorized extension(s) of time as approved by written agreement. Final Completion of the Work shall be no later than thirty (30) consecutive calendar days from the date of Substantial Completion of the Work, unless otherwise set forth in Article 3.2 of the Owner/Contractor Agreement.

§ 8.1.2 Intentionally omitted

§ 8.1.3 Intentionally omitted.

§ 8.1.4 The term "day" as used in the Contract Documents shall mean calendar day unless otherwise specifically defined.

§ 8.2 PROGRESS AND COMPLETION

§ 8.2.1 Time limits stated in the Contract Documents are of the essence of the Contract. By executing the Agreement the Contractor confirms that the Contract Time is a reasonable period for performing the Work. There will be no bonus or incentives paid, should the Work, or any portion thereof, be completed in advance of the specified activity milestone dates.

§ 8.2.2 The Contractor shall not knowingly, except by agreement or instruction of the Owner in writing, prematurely commence operations on the site or elsewhere prior to the effective date of insurance required by Article 11 to be furnished by the Contractor and Owner. The date of commencement of the Work shall not be changed by the effective date of such insurance.

§ 8.2.3 The Contractor shall proceed expeditiously with adequate forces and shall achieve Substantial Completion within the Contract Time.

§ 8.3 DELAYS AND EXTENSIONS OF TIME

§ 8.3.1 Intentionally omitted

§ 8.3.2 Claims relating to time shall be made in accordance with applicable provisions of Article 15.

§ 8.3.3 Intentionally omitted

§ 8.3.4 No payment, compensation, or adjustment of any kind shall be made to the Contractor by the Owner for damages resulting from hindrances or delays caused by the delays of other contractors, or from foreseeable circumstances not attributable to the Owner's conduct. The Contractor agrees that it will make no claim against the Owner for payment, compensation, damages, mitigation of Liquidated Damages, or adjustment of any kind for such hindrances or delays, and will accept such extensions of time as may be granted by the Owner in the Owner's sole discretion in full satisfaction for any and all alleged claims against the Owner for any and all such hindrances or delays. For purposes of this Agreement, disputes arising between contractors before or during construction, adverse weather conditions, and delays on the part of local authorities issuing permits shall be considered foreseeable circumstances. Notwithstanding the foregoing, nothing herein shall limit the Contractor's remedies for Owner's negligence, bad faith, active interference, tortious conduct, or other reasons unanticipated by the parties that delay expenditures paid by the Owner to the Engineer, or his designee, other individual or entity, or to any inspector or inspectors necessarily employed by it on the Work, for any number of days in excess of the Contract Time, shall be deducted for the Contract Sum.

§ 8.3.5 The provisions of this Article shall not be so interpreted or construed as to preclude or prevent the Contractor from making and prosecuting any claim against any separate Contractor engaged or employed by the Owner for damages alleged to have been caused or occasioned by any such separate Contractor.

§ 8.3.6 To the extent permitted by law, the Owner may suspend the whole or any part of the Work, if it shall deem it for the best interest of the Owner to do so, without compensation to the Contractor for such suspension, other than extending the time for completion of the Work as much as it may have been delayed by such suspension. During such suspension, all materials delivered upon, but not placed in the Work shall be neatly piled by the Contractor so as not to obstruct public travel, or shall be removed from the line of Work at the direction of the Owner and, unless the

materials be moved by the Contractor upon such direction, the materials shall be removed by the Owner and expense thereof will be charged to the Contractor.

§8.4.1 Should the Contractor fail to complete fully, and in conformity with all provisions of the Contract within the Contract Time, the Contractor shall, and hereby agrees to, pay the Owner one thousand dollars (\$1,000.00) per day, for each consecutive calendar day beyond the number of days allowed by the Contract, which sum is agreed upon as reasonable and proper measure of damages that the Owner will sustain per diem by failure of Contractor to complete Work within time as stipulated; it being recognized by Owner and Contractor that the injury to Owner that could result from a failure of the Contractor to complete on schedule, is uncertain and cannot be computed exactly. In no way shall costs of Liquidated Damages be construed as a penalty to the Contractor.

§8.4.2 It is expressly understood and agreed by and between the Contractor and Owner that the Contract Time prescribed herein is a reasonable time for the completion of the Work.

ARTICLE 9 PAYMENTS AND COMPLETION

§ 9.1 CONTRACT SUM

The Contract Sum is stated in the Agreement and, including authorized adjustments, is the total amount payable by the Owner to the Contractor for performance of the Work under the Contract Documents.

§ 9.2 SCHEDULE OF VALUES

Where the Contract is based on a stipulated sum or Guaranteed Maximum Price, the Contractor shall submit to the Engineer, or his designee, before the first Application for Payment, a schedule of values allocating the entire Contract Sum to the various portions of the Work and prepared in such form and supported by such data to substantiate its accuracy as the Engineer, or his designee may require. This schedule, unless objected to by the Engineer, or his designee, shall be used as a basis for reviewing the Contractor's Applications for Payment.

§ 9.3 APPLICATIONS FOR PAYMENT

§ 9.3.1 See Article 5 of Standard Form of Agreement between Owner/Contractor.

§ 9.3.1.1 Applications for Payment may include requests for payment on account of changes in the Work which have been properly authorized by Construction Change Directives but not yet included in Change Orders.

§ 9.3.1.2 Such applications may not include requests for payment of amounts the Contractor does not intend to pay to a Subcontractor or material supplier because of a dispute or other reason.

§ 9.3.1.3 All applications for payment shall be accompanied by the Application and Certificate of Payment, AIA Document G702, and the Continuation Sheet, AIA Document G703, fully completed as required or such other application for Payment as the Owner's representative shall use.

§9.3.1.4 In cases where the work is awarded on a Single Overall Contract basis, payments shall be made in accordance with applicable State of New Jersey statutes.

§ 9.3.2 Unless otherwise provided in the Contract Documents, payments shall be made on account of materials and equipment delivered and suitably stored at the site for subsequent incorporation in the Work. If approved in advance by the Owner, payment may similarly be made for materials and equipment suitably stored off the site at a location agreed upon in writing. Payment for materials and equipment stored on or off the site shall be conditioned upon compliance by the Contractor with procedures satisfactory to the Owner to establish the Owner's title to such materials and equipment or otherwise protect the Owner's interest, and shall include the costs of applicable insurance, storage and transportation to the site for such materials and equipment stored off the site.

§ 9.3.3 The Contractor warrants that title to all Work covered by an Application for Payment will pass to the Owner no later than the time of payment. The Contractor further warrants that upon submittal of an Application for Payment all Work for which Certificates for Payment have been previously issued and payments received from the Owner shall, to the best of the Contractor's knowledge, information and belief, be free and clear of liens, claims, security interests or encumbrances in favor of the Contractor, Subcontractors, material suppliers, or other persons or entities making a claim by reason of having provided labor, materials and equipment relating to the Work.

§9.3.3.1 All municipal mechanic's liens filed by a lien claimant shall be governed by N.J.S.A. 2A:44-125 et seq. In the event a municipal mechanic's lien is filed, the Owner reserves the right to withhold the full amount of the lien. The Owner may release the funds to the party against whose account the lien is claimed, only after that party files with the Owner's financial officer, a bond in an amount double of all sums claimed ("Double Bond") under the lien, and such bond's form has been approved by the Owner's chief law officer and financial officer, per N.J.S.A. 2A:44-130 or if an acceptable release of liens is filed by the lien claimant.

§ 9.4 CERTIFICATES FOR PAYMENT

§ 9.4.1 See Article 5 of Standard Form of Agreement between Owner and Contractor.

§ 9.4.2 See Article 5 of Standard Form of Agreement between Owner and Contractor

§9.4.3 See Article 5 of Standard Form of Agreement between Owner and Contractor.

§ 9.5 DECISIONS TO WITHHOLD CERTIFICATION

§ 9.5.1 See Article 5 of Standard Form of Agreement between Owner and Contractor

§ 9.5.2 See Article 5 if Standard Form of Agreement between Owner and Contractor.

§ 9.6 PROGRESS PAYMENTS

§ 9.6.1 After the Engineer, or his designee has issued a Certificate for Payment, the Owner shall make payment in the manner and within the time provided in the Contract Documents, and shall so notify the Engineer, or his designee .

§ 9.6.2 The Contractor shall promptly pay each Subcontractor, upon receipt of payment from the Owner, out of the amount paid to the Contractor on account of such Subcontractor's portion of the Work, the amount to which the Subcontractor is entitled, reflecting percentages actually retained from payments to the Contractor on account of the Subcontractor's portion of the Work and shall certify same to Owner. The Contractor shall, by appropriate agreement with each Subcontractor, require each Subcontractor to make payments to Sub-subcontractors in a similar manner.

§ 9.6.3 The Engineer, or his designee will, on request, furnish to a Subcontractor, if practicable, information regarding percentages of completion or amounts applied for by the Contractor and action taken thereon by the Owner and Engineer, or his designee on account of portions of the Work done by such Subcontractor.

§ 9.6.4 Neither the Owner nor Engineer, or his designee shall have an obligation to pay or to see to the payment of money to a Subcontractor except as may otherwise be required by law.

§ 9.6.5 Payment to material and equipment suppliers shall be treated in a manner similar to that provided in Sections 9.6.2, 9.6.3 and 9.6.4.

§ 9.7 FAILURE OF PAYMENT

If the Engineer, or his designee does not issue a Certificate for Payment, through no fault of the Contractor, within seven days after receipt of the Contractor's Application for Payment, or if the Owner does not pay the Contractor within seven days after the date established in the Contract Documents the amount certified by the Engineer, or his designee or awarded by binding dispute resolution, then the Contractor may, upon seven additional days' written notice to the Owner and Engineer, or his designee , stop the Work until payment of the amount owing has been received. The Contract Time shall be extended appropriately and the Contract Sum shall be increased by the amount of the Contractor's reasonable costs of shut-down, delay and start-up, plus interest as provided for in the Contract Documents.

§9.7 REIMBURSEMENT TO OWNER

§9.7.1 If the Owner is entitled to any reimbursement or payment from the Contractor under, or pursuant to, the Contract Documents, such payment shall be made promptly upon demand by the Owner. Notwithstanding anything contained in the Contract Documents to the contrary, if the Contractor fails to promptly make any payment due the Owner, or the Owner incurs any costs and expenses to cure any default of the Contractor or to correct defective Work, the Owner shall have an absolute right to offset such amount against the Contract Sum and may, in the Owner's sole discretion, elect either to: (1) deduct an amount equal to that which the Owner is entitled from any

payment then, or thereafter, due the Contractor from the Owner; or (2) issue a written notice to the Contractor reducing the Contract Sum by an amount equal to that which the Owner is entitled.

§ 9.8 SUBSTANTIAL COMPLETION

§ 9.8.1 Substantial Completion is the stage in the progress of the Work when the Work or designated portion thereof is sufficiently complete in accordance with the Contract Documents so that the Owner can occupy or utilize the Work for its intended use; provided, however, that a condition precedent to Substantial Completion shall be the Owner's receipt of all certificates of occupancy (permanent or temporary) and any other permits, approvals, licenses, and other documents from any governmental authority having jurisdiction thereof necessary for the occupancy of the Project. The Owner may withhold a certification of Substantial Completion if temporary installations or temporary construction exists in areas requesting certification, or if certificates of occupancy are temporary or conditional.

§ 9.8.2 When the Contractor considers that the Work, or a portion thereof which the Owner agrees to accept separately, is substantially complete, the Engineer, or his designee shall prepare a comprehensive list of items to be completed or corrected ("Punch List"). The Contractor shall proceed immediately and correct items on the list. Failure to include an item on such list does not alter the responsibility of the Contractor to complete all Work in accordance with the Contract Documents. Upon receipt of the list, the Engineer, or his designee, will make an inspection to determine whether the Work or designated portion thereof is substantially complete. If the Engineer, or his designee's inspection discloses any item, whether or not included on the list, which is not in accordance with the requirements of the Contract Documents, the Contractor shall, before issuance of the Certificate of Substantial Completion, complete or correct such item upon notification by the Engineer, or his designee. The Contractor shall then submit a request for another inspection by the Engineer, or his designee to determine Substantial Completion. When the Work or designated portion thereof is substantially complete, the Engineer, or his designee will prepare a Certificate of Substantial Completion which shall establish the date of Substantial Completion, shall establish responsibilities of the Contractor for security, maintenance, heat, utilities, damage to the Work and insurance, and shall fix the time within which the Contractor shall finish all items on the List accompanying the Certificate. Warranties required by the Contract Documents shall commence on the date of Substantial Completion of the Work or designated portion thereof unless otherwise provided in the Certificate of Substantial Completion. The Certificate of Substantial Completion shall be submitted to the Contractor for its written acceptance and to the Owner for its approval and acceptance as required by Section 9.8.1. No Certificate of Substantial Completion shall be deemed effective unless executed by both Owner and Contractor.

§ 9.9 PARTIAL OCCUPANCY OR USE

§ 9.9.1 The Owner may occupy or use any completed or partially completed portion of the Work at any stage when such portion is designated by separate agreement with the Contractor, who shall obtain all necessary modifications to its insurance coverage to permit such occupancy or use. In addition, Contractor shall obtain consent of those public authorities having jurisdiction over the Work. Such partial occupancy or use may commence whether or not the portion is substantially complete pursuant to the terms of that Agreement. When the Contractor considers a portion substantially complete, the Engineer, or his designee shall prepare a Punch List as provided under Section 9.8.2. Consent of the Contractor to partial occupancy or use shall not be unreasonably withheld.

§ 9.9.2 Immediately prior to such partial occupancy or use, the Owner, Contractor and Engineer, or his designee shall jointly inspect the area to be occupied or portion of the Work to be used in order to determine and record the condition of the Work.

§ 9.9.3 Unless otherwise agreed upon, partial occupancy or use of a portion or portions of the Work shall not constitute acceptance of Work not complying with the requirements of the Contract Documents.

§ 9.9.4 The occupancy of any portion of the Work shall not constitute acceptance of any Work, except as hereinafter stated, nor does it waive the Owner's right to Liquidated Damages. Final Acceptance of the Work shall be for the whole Work only and not part.

§ 9.9.5 Occupancy by the Owner shall not be deemed to constitute a waiver of existing claims on behalf of the Owner or Contractor against each other.

§ 9.10 FINAL COMPLETION AND FINAL PAYMENT

§ 9.10.1 Upon completion of the Work, the Contractor shall forward to the Engineer, or his designee a written notice that the Work is ready for final inspection and acceptance and shall also forward to the Engineer, or his designee a final Contractor's Application for Payment. The Engineer, or his designee will promptly make such inspection. When the Engineer, or his designee finds the Work acceptable under the Contract Documents and the Contract fully performed, the Engineer, or his designee will promptly issue a final Certificate for Payment stating that to the best of their knowledge, information and belief, and on the basis of their observations and inspections, the Work has been completed in accordance with terms and conditions of the Contract Documents and that the entire balance found to be due the Contractor and noted in the final Certificate is due and payable. The Engineer, or his designee's final Certificate for Payment will constitute a further representation that conditions listed in Section 9.10.2 as precedent to the Contractor's being entitled to final payment have been fulfilled.

§ 9.10.2 Neither final payment nor any remaining retained percentage shall become due until the Contractor complies with all requirements set forth in Section 6 of the Standard Form of Agreement between Owner and Contractor and the Contractor submits to the Engineer, or his designee (1) an affidavit that payrolls, bills for materials and equipment, and other indebtedness connected with the Work for which the Owner or the Owner's property might be responsible or encumbered (less amounts withheld by Owner) have been paid or otherwise satisfied, (2) a certificate evidencing that insurance required by the Contract Documents to remain in force after final payment is currently in effect and will not be canceled or allowed to expire until at least 30 days' prior written notice has been given to the Owner, (3) a written statement that the Contractor knows of no substantial reason that the insurance will not be renewable to cover the period required by the Contract Documents, (4) consent of surety, if any, to final payment and (5), if required by the Owner, other data establishing payment or satisfaction of obligations, such as receipts, releases and waivers of liens, claims, security interests or encumbrances arising out of the Contract, to the extent and in such form as may be designated by the Owner. If a Subcontractor refuses to furnish a release or waiver required by the Owner, the Contractor may furnish a bond satisfactory to the Owner to indemnify the Owner against such lien. If such lien remains unsatisfied after payments are made, the Contractor shall refund to the Owner all money that the Owner may be compelled to pay in discharging such lien, including all costs and reasonable attorneys' fees.

§ 9.10.3 Intentionally omitted

§ 9.10.4 Acceptance of final payment by the Contractor, a Subcontractor or material supplier shall constitute a waiver of claims by that payee

ARTICLE 10 PROTECTION OF PERSONS AND PROPERTY

§ 10.1 SAFETY PRECAUTIONS AND PROGRAMS

The Contractor shall be responsible for initiating, maintaining and supervising all safety precautions and programs in connection with the performance of the Contract. The Contractor shall submit the Contractor's safety program to the Engineer, or his designee for review and coordination with the safety programs of other Contractors.

§ 10.2 SAFETY OF PERSONS AND PROPERTY

§ 10.2.1 The Contractor shall take reasonable precautions for safety of, and shall provide reasonable protection to prevent damage, injury or loss to

- .1 employees on the Work and other persons who may be affected thereby;
- .2 the Work and materials and equipment to be incorporated therein, whether in storage on or off the site, under care, custody or control of the Contractor or the Contractor's Subcontractors or Sub-subcontractors; and
- .3 other property at the site or adjacent thereto, such as trees, shrubs, lawns, walks, pavements, roadways, structures and utilities not designated for removal, relocation or replacement in the course of construction.
- .4 Construction or operations by the Owner or other Contractors.

§ 10.2.2 The Contractor shall comply with and give notices required by applicable laws, statutes, ordinances, codes, rules and regulations, and lawful orders of public authorities bearing on safety of persons or property or their protection from damage, injury or loss.

§ 10.2.3 The Contractor shall erect and maintain, as required by existing conditions and performance of the Contract, reasonable safeguards for safety and protection, including posting danger signs and other warnings against hazards, promulgating safety regulations and notifying Owners and users of adjacent sites and utilities.

§ 10.2.4 When use or storage of explosives or other hazardous materials or equipment or unusual methods are necessary for execution of the Work, the Contractor shall exercise utmost care and carry on such activities under supervision of properly qualified personnel.

§ 10.2.5 The Contractor shall promptly remedy damage and loss (other than damage or loss insured under property insurance required by the Contract Documents) to property referred to in Sections 10.2.1.2, 10.2.1.3 and 10.2.1.4 caused in whole or in part by the Contractor, a Subcontractor, a Sub-subcontractor, or anyone directly or indirectly employed by any of them, or by anyone for whose acts they may be liable and for which the Contractor is responsible under Sections 10.2.1.2, 10.2.1.3 and 10.2.1.4, except damage or loss attributable to acts or omissions of the Owner or Engineer, or his designee or anyone directly or indirectly employed by either of them, or by anyone for whose acts either of them may be liable, and not attributable to the fault or negligence of the Contractor. The foregoing obligations of the Contractor are in addition to the Contractor's obligations under Section 3.18.

§ 10.2.6 The Contractor shall designate a responsible member of the Contractor's organization at the site whose duty shall be the prevention of accidents. This person shall be the Contractor's superintendent unless otherwise designated by the Contractor in writing to the Owner and Engineer, or his designee.

§ 10.2.7 The Contractor shall not permit any part of the construction or site to be loaded so as to cause damage or create an unsafe condition.

§ 10.2.8 INJURY OR DAMAGE TO PERSON OR PROPERTY

If either party suffers injury or damage to person or property because of an act or omission of the other party, or of others for whose acts such party is legally responsible, written notice of such injury or damage, whether or not insured, shall be given to the other party within a reasonable time not exceeding 21 days after discovery. The notice shall provide sufficient detail to enable the other party to investigate the matter.

§ 10.3 HAZARDOUS MATERIALS

§ 10.3.1 The Contractor is responsible for compliance with any requirements included in the Contract Documents regarding hazardous materials. If the Contractor encounters a hazardous material or substance not addressed in the Contract Documents and if reasonable precautions will be inadequate to prevent foreseeable bodily injury or death to persons resulting from a material or substance, including but not limited to asbestos or polychlorinated biphenyl (PCB), encountered on the site by the Contractor, the Contractor shall, upon recognizing the condition, immediately stop Work in the affected area and report the condition to the Owner and Engineer, or his designee in writing.

§ 10.3.2 Upon receipt of the Contractor's written notice, the Owner shall obtain the services of a licensed laboratory to verify the presence or absence of the material or substance reported by the Contractor and, in the event such material or substance is found to be present, to cause it to be rendered harmless. Unless otherwise required by the Contract Documents, the Owner shall furnish in writing to the Contractor and Engineer, or his designee the names and qualifications of persons or entities who are to perform tests verifying the presence or absence of such material or substance or who are to perform the task of removal or safe containment of such material or substance.

§ 10.3.3 Intentionally omitted

§ 10.3.4 The Owner shall not be responsible under this Section 10.3 for materials or substances the Contractor brings to the site unless such materials or substances are required by the Contract Documents. The Owner shall be responsible for materials or substances required by the Contract Documents, except to the extent of the Contractor's fault or negligence in the use and handling of such materials or substances.

§ 10.3.5 The Contractor shall indemnify the Owner for the cost and expense the Owner incurs (1) for remediation of a material or substance the Contractor brings to the site and negligently handles, or (2) where the Contractor fails to perform its obligations under Section 10.3.1, except to the extent that the cost and expense are due to the Owner's fault or negligence.

§ 10.3.6 Intentionally omitted

§ 10.4 EMERGENCIES

In an emergency affecting safety of persons or property, the Contractor shall act, at the Contractor's discretion, to prevent threatened damage, injury or loss. Additional compensation or extension of time claimed by the Contractor on account of an emergency shall be determined as provided in Article 15 and Article 7.

ARTICLE 11 INSURANCE AND BONDS

§ 11.1 CONTRACTOR'S LIABILITY INSURANCE

§ 11.1.1 The County of Union requires all bidders to be able to comply with the following insurance requirements. In the event a bid is accepted by the County, the bidder must accept the applicable insurance requirements, as set forth below, as part of any contract, awarded to it by the County.

1. Automobile Liability Insurance in any amount of not less than \$1,000,000.00 combined single limits for Bodily Injury and Property Damage Liability. A certificate of such current insurance will be provided to the County and will reflect the provision of at least thirty (30) days notice to the County before any major cancellation or major change may be made the policy.

2. Workers Compensation Insurance insuring the obligations of the Contractor and all Subcontractors under the New Jersey Workers Compensation and Occupational Disability Laws as respects to Work performed under the Contract. Insurance will be extended to include any obligations under the United States Longshoremen's and Harbor Workers Act or any maritime act, when applicable.

3. General Liability Insurance will be provided on a Comprehensive General Liability form with a combined single limit of \$3,000,000.00 per occurrence for Bodily Injury Liability and Property Damage Liability and will include the interest of the County with respect to Work emanating from the Contract with the County. The insurance will include the following:

- a) Personal Injury Liability
- b) Blanket Contractual Liability applies to assumption of liability under any written Contract
- c) Coverage for A, X, C, U exposures, relating to excavation, blasting underground damage
- d) Broad Form Property Damage Liability
- e) Products and/or Completed Operations Liability

A Certificate of Insurance will be filed with the County prior to commencement of any Work. This certificate will contain a provision that insurance afforded under the policies will not be canceled without at least (30) days prior written notice being given to the County.

.1

§ 11.1.2 The insurance required by Section 11.1.1 shall remain in effect for the duration of the project, i.e., from beginning of construction until final payment and closeout.

§ 11.1.3 All insurance required by Section 11.1.1 shall be issued by insurance companies authorized to do business in the State of New Jersey and rated as "A" or better as determined by A.M. Best Company.

§ 11.1.4 The Contractor waives all rights against the Owner for damages caused by fire or other perils to the extent covered by insurance provided under this Article. Any deductibles, co-insurance, or contribution to the loss will be borne solely by the Contractor.

§ 11.1.5 A certificate of insurance evidencing the coverages required by Section 11.1.1 shall be submitted to the Owner's attorney for approval and transmittal to the Owner and Engineer, or his designee prior to the commencement of the Work. The certificate must be submitted on the ACORD form Certificate of Insurance. These certificates and the insurance policies required by this Section 11.1 shall contain a provision that coverages afforded under the policies will not be canceled or allowed to expire until at least thirty (30) days written notice has been given to the Owner. If requested by the Owner, the Contractor shall provide complete copies of any policies of insurance required by this Contract to be obtained by the Contractor and Subcontractor(s). Information concerning any reduction of coverage shall be furnished by the Contractor with reasonable promptness in accordance with the Contractor's information and belief.

§ 11.2 PROPERTY INSURANCE

§ 11.2.1 Unless otherwise provided, the Owner shall purchase and maintain, in a company or companies lawfully authorized to do business in the jurisdiction in which the Project is located, property insurance in the amount of the initial Contract Sum as well as subsequent modifications thereto for the entire Work at the site on a replacement cost

basis without voluntary deductibles. Such property insurance shall be maintained, unless otherwise provided in the Contract Documents or otherwise agreed in writing by all persons and entities who are beneficiaries of such insurance, until final payment has been made as provided in Section 9.10 or until no person or entity other than the Owner has an insurance interest in the property required by this Section 11.2 to be covered, whichever is earlier. This insurance shall include the interest of the Owner, Contractor, Subcontractor(s), and Sub-Contractor(s) in the Work.

§ 11.2.1.1 Property insurance shall be on an "all-risk" policy form and shall be against the perils of fire and extended coverage and physical loss or damage including, without duplication of coverage, theft, vandalism, malicious mischief, collapse, falsework, temporary buildings and debris removal including demolition occasioned by enforcement of any applicable legal requirements, and shall cover reasonable compensation for Engineer, or his designee's services and expenses required as a result of such insured loss. Coverage for all other perils shall not be required unless otherwise provided in the Contract Documents.

§ 11.2.1.2 If the Owner does not intend to purchase such property insurance required by the Contract and with all of the coverages in the amount described above, the Owner shall so inform the Contractor in writing prior to commencement of the Work. The Contractor may then effect insurance which will protect the interests of the Contractor, Subcontractor(s) and Sub-subcontractor(s) in the Work. If the Contractor is damaged by the failure or neglect of the Owner to purchase or maintain insurance as described above, without so notifying the Contractor, then the Owner shall bear all reasonable costs properly attributable thereto.

§ 11.2.1.3 If the property insurance requires minimum deductibles, and such deductibles are identified in the Contract Documents, the Contractor shall pay costs not covered because of such deductibles. If the Owner or insurer increases the required minimum deductibles over the amounts so identified or if the Owner elects to purchase this insurance with voluntary deductible amounts, the Owner shall be responsible for payment of the additional costs not covered because of such increased or voluntary deductibles.

§ 11.2.1.4 Unless otherwise provided in the Contract documents, this property insurance shall cover portions of the Work stored off the site after written approval of the Owner at the value established in the approval, and also portions of the Work in transit.

§ 11.2.1.5 A loss insured under Owner's property insurance shall be adjusted by the Owner as fiduciary and made payable to the Owner as fiduciary for the insureds, as their interests may appear, subject to requirements of any applicable mortgage clause and of Section 11.3.10. The Contractor shall pay Subcontractor(s) their just shares of insurance proceeds received the Contractor, and by appropriate agreements, written where legally required for validity, shall require Subcontractor(s) to make payments to their Sub-Contractor(s) in a similar manner.

§ 11.2.2 BOILER AND MACHINERY INSURANCE

The Owner shall purchase and maintain boiler and machinery insurance required by the Contract Documents or by law, which shall specifically cover such insured objects during installation and until final acceptance by the Owner; this insurance shall include interests of the Owner, Contractor, Subcontractors and Sub-subcontractors in the Work, and the Owner and Contractor shall be named insureds. The Owner as fiduciary shall have the power to adjust and settle a loss with insurers.

§ 11.2.3 LOSS OF USE INSURANCE

The Owner, at the Owner's option, may purchase and maintain such insurance as will insure the Owner against loss of use of the Owner's property due to fire or other hazards, however caused.

§ 11.2.4 If the Contractor requests in writing that insurance for risks other than those described herein or other special causes of loss be included in the property insurance policy, the Owner shall, if possible, include such insurance, and the cost thereof shall be charged to the Contractor by appropriate Change Order.

§ 11.3 PERFORMANCE BOND, PAYMENT BOND AND MAINTENANCE BOND

§ 11.3.1 Contractor, at its sole expense, shall furnish bonds covering faithful performance of the contract and payment of obligations arising thereunder as stipulated in bidding requirements or specifically required in the Contract Documents on the date of execution of the Contract, including material and labor..

§ 11.3.2 Upon the request of any person or entity appearing to be a potential beneficiary of bonds covering payment of obligations arising under the Contract, the Contractor shall promptly furnish a copy of the bonds or shall authorize a copy to be made

§ 11.3.3 The Contractor shall file with the Owner, as a condition of final acceptance, a statement from the Surety of its Performance Bond and Payment Bond, that the Surety is satisfied that all claims for labor and material supplied under its contract have been satisfactorily settled.

§ 11.3.4 As a condition of Substantial Completion of the Work, the Contractor shall provide an acceptable Maintenance Bond in accordance with section 16, page G-9 of the Instructions to Bidders.

ARTICLE 12 UNCOVERING AND CORRECTION OF WORK

§ 12.1 UNCOVERING OF WORK

§ 12.1.1 If a portion of the Work uncovered is contrary to the Engineer, or his designee's request or to requirements specifically expressed in the Contract Documents, it must, if requested in writing by the Engineer, or his designee, be uncovered for the Engineer, or his designee's examination and be replaced at the Contractor's expense without change in the Contract Time or Contract Sum.

§ 12.1.2 If a portion of the Work has been covered that the Engineer, or his designee has not specifically requested to examine prior to its being covered, the Engineer, or his designee may request to see such Work and it shall be uncovered by the Contractor. If such Work is in accordance with the Contract Documents, costs of uncovering and replacement shall, by appropriate Change Order, be at the Owner's expense. If such Work is not in accordance with the Contract Documents, such costs and the cost of correction shall be at the Contractor's expense unless the condition was caused by the Owner or a separate Contractor in which event the Owner shall be responsible for payment of such costs.

§ 12.2 CORRECTION OF WORK

The Contractor shall promptly correct Work rejected by the Engineer, or his designee or failing to conform to the requirements of the Contract Documents, whether discovered before or after Substantial Completion and whether or not fabricated, installed or completed. Costs of correcting such rejected Work, including additional testing and inspections, the cost of uncovering and replacement, and compensation for the Engineer, or his designee's services and expenses made necessary thereby, shall be at the Contractor's expense.

§ 12.2.2.1 In addition to the Contractor's obligations under Section 3.5, if, within one year after the date of Substantial Completion of the Work or designated portion thereof or after the date for commencement of warranties established under Section 9.9.1, or by terms of an applicable special warranty required by the Contract Documents any of the Work is found to be not in accordance with the requirements of the Contract Documents, the Contractor shall correct it promptly after receipt of written notice from the Owner to do so unless the Owner has previously given the Contractor a written acceptance of such condition. The Owner shall give such notice promptly after discovery of the condition. The Contractor shall give such notice promptly after discovery of the non-conforming work. If the Contractor fails to correct nonconforming Work within a reasonable time during that period after the receipt of notice from the Owner or Engineer, or his designee, the Owner may correct it in accordance with Section 2.4. This obligation under Section 12.2.2 shall survive acceptance of the Work under the Contract and termination of the Contract.

§ 12.2.2.2 The one-year period for correction of Work shall be extended with respect to portions of Work first performed after Substantial Completion by the period of time between Substantial Completion and the actual completion of that portion of the Work.

§ 12.2.2.3 Intentionally omitted.

§ 12.2.3 The Contractor shall remove from the site portions of the Work that are not in accordance with the requirements of the Contract Documents and are neither corrected by the Contractor nor accepted by the Owner.

§ 12.2.4 The Contractor shall bear the cost of correcting destroyed or damaged work, whether completed or partially completed, of the Owner or separate contractors caused by the Contractor's correction or removal of Work that is not in accordance with the requirements of the Contract Documents.

§ 12.2.5 Nothing contained in this Section 12.2 shall be construed to establish a period of limitation with respect to other obligations the Contractor has under the Contract Documents. Establishment of the one-year period for correction of Work as described in Section 12.2.2 relates only to the specific obligation of the Contractor to correct the Work, and has no relationship to the time within which the obligation to comply with the Contract Documents may be sought to be enforced, nor to the time within which proceedings may be commenced to establish the Contractor's liability with respect to the Contractor's obligations other than specifically to correct the Work, nor to any deficient Work discovered after the one-year period that could not have readily been discovered.

§ 12.3 ACCEPTANCE OF NONCONFORMING WORK

If the Owner prefers to accept Work, that is not in accordance with the requirements of the Contract Documents, the Owner may do so instead of requiring its removal and correction, in which case the Contract Sum will be reduced as appropriate and equitable. Such adjustment shall be effected whether or not final payment has been made. However, there shall be no implied or expressed acceptance of Work not in compliance with applicable law. The amount of said reduction will be within the exclusive determination of the Owner as its representative.

ARTICLE 13 MISCELLANEOUS PROVISIONS

§ 13.1 GOVERNING LAW

§ 13.1.1 The Contract shall be governed by the laws of the State of New Jersey.

§ 13.1.2 Nothing in the Contract Documents shall be construed to permit deviation from the governing law.

§ 13.1.3 In accordance with N.J.S.A. 40A:11-18, American manufactured products or materials shall be used in the Work, wherever possible.

13.1.4 RATE OF WAGES

Where the Project is not subject to a Project Labor Agreement, wage notes shall be paid pursuant to the New Jersey Prevailing Wage Act, N.J.S.A. 34:11-56.25 et seq, the Contractor and Subcontractor are required to do the following:

§ 13.1.4.1 Pay to all workmen engaged in the performance of services, directly upon a public work, the prevailing rate of wages, which shall be those in effect for the Project site(s) on the Contract Date and such rates shall remain in effect for (2) years, unless superseded by a subsequent determination.

§ 13.1.4.2 Before final payment, furnish Owner with an affidavit stating that all workmen have been paid the prevailing rate of wages specified in the contract.

§ 13.1.4.3 Keep an accurate record showing the name, craft, or trade and actual hourly rate of wages paid to each workman employed by it in connection with any public work. Records shall be preserved for two (2) years from date of payment.

§ 13.1.4.4 Post the prevailing wage rated for each craft and classification involved as determined by the Commissioner of Labor and Industry, including the effective date of any changes thereof in prominent and easily accessible places at the site of the Work, and at such place or places as are used by them to pay workmen their wages.

§ 13.1.4.5 Submit the Owner, certified payroll records for each payroll period within ten (10) days of the payment of wages. A certified payroll record is defined as "a payroll record that is attested by the employer or the Owner of the company doing business as the employer, or a corporate officer of such company, or an authorized agent of the employer". A copy of the certified payroll form for submission of the payroll records may be obtained by contacting the Department of Labor, Division of Workplace Standards at 609.292.2259.

§ 13.1.4.6 In the event the Owner finds that any workers employed by the Contractor or Subcontractor, covered by the said contract, have been paid a rate of wages less than the prevailing wage required to be paid by such contract, the Owner may terminate the Contractor's or Subcontractor's right to proceed with the Work, or such part of the

Work as to where there has been a failure to pay required wages, and to prosecute the Work to completion or otherwise, the Contractor and its sureties shall be liable to the Owner for any excess costs occasioned thereby,

§ 13.1.4.7 a current wage rate determination is on file at the offices of the Owner for inspection and Contractor's use.

§ 13.1.5 SAFETY AND HEALTH REGULATIONS (OSHA)

§ 13.1.5.1 The Contractor shall comply with the laws, rules, regulations and codes dealing with occupational safety and health, including, but not limited to, the latest amendments of the following:

§ 13.1.5.2 Williams – Steiger Occupational Safety and Health Act of 1970, Public Law 91-595

§ 13.1.5.3 Part 1910 – Occupational Safety and Health Standards Chapter XVII of Title 29, Code of Federal Regulations.

§ 13.1.5.4 Part 126 – Safety and Health Regulations for Construction, Chapter XVII of Title 29, Code of Federal Regulations.

§ 13.1.5.3 N.J.A.C. 8:59-5.1-5.109 requirements properly label any substances stored in containers) of the Worker and Community Right to Know Act, P.L. 1983, c.315.

§ 13.1.6 ENVIRONMENTAL REGULATIONS

§ 13.1.6.1 The Contractor shall comply with laws, rules, regulations, and codes dealing with the prevention of environmental pollution and the preservation of public natural resources, including but not limited to, the latest amendments of the following:

§ 13.1.6.2 Chapter 251, public Law of 1975 of the State of New Jersey, "soil Erosion and Sediment Control Act."

§ 13.1.7 AFFIRMATION ACTION EMPLOYMENT LAW

Contractor agrees to comply with the terms of the Mandatory Equal Employment Opportunity Language, a copy of which is annexed to the Contract Documents as Exhibit F and incorporated as if set forth herein.

§ 13.1.7.1 Contractor shall submit a copy of the Monthly Project Workforce Report, New Jersey Department of Treasury Form AA-202, to the New Jersey Department of Treasury's Division of Public Contracts Equal Employment Opportunity Compliance and to the Owner

§ 13.1.7.2 Contractor shall complete and submit to the Owner an Initial Project Workforce Report, New Jersey Department of Treasury Form AA 201, upon notification of award and no later than the execution of this Agreement. Failure to submit this completed form may result in this Agreement being terminated.

§ 13.2. SUCCESSORS AND ASSIGNS

§ 13.2.1 The Owner and Contractor respectively bind themselves, their partners, successors, assigns and legal representatives to covenants, agreements and obligations contained in the Contract Documents, neither party to the Contract shall assign the Contract as a whole without written consent of the other, unless as may be provided for elsewhere in the Contract Documents. If either party attempts to make such an assignment without such consent, that party shall nevertheless remain legally responsible for all obligations under the Contract.

§ 13.3 WRITTEN NOTICE

Written notice shall be deemed to have been duly served if delivered in person to the individual, to a member of the firm or entity, or to an officer of the corporation for which it was intended; or if delivered at or sent by registered or certified mail or by courier service providing proof of delivery to, the last business address known to the party giving notice.

§ 13.4 RIGHTS AND REMEDIES

§ 13.4.1 Duties and obligations imposed by the Contract Documents and rights and remedies available thereunder shall be in addition to and not a limitation of duties, obligations, rights and remedies otherwise imposed or available by law.

§ 13.4.2 No action or failure to act by the Owner, Engineer, or his designee or Contractor shall constitute a waiver of a right or duty afforded them under the Contract, nor shall such action or failure to act constitute approval of or acquiescence in a breach there under, except as may be specifically agreed in writing.

§ 13.5 TESTS AND INSPECTIONS

§ 13.5.1 Tests, inspections and approvals of portions of the Work shall be made as required by the Contract Documents and by applicable laws, statutes, ordinances, codes, rules and regulations or lawful orders of public authorities. Unless otherwise provided, the Contractor shall make arrangements for such tests, inspections and approvals with an independent testing laboratory or entity acceptable to the Owner, or with the appropriate public authority, and shall bear all related costs of tests, inspections and approvals. The Contractor shall give the Engineer, or his designee timely notice of when and where tests and inspections are to be made so that the Engineer, or his designee may be present for such procedures. The Owner shall bear costs of (1) tests, inspections or approvals that do not become requirements until after bids are received or negotiations concluded, and (2) tests, inspections or approvals where building codes or applicable laws or regulations prohibit the Owner from delegating their cost to the Contractor.

§ 13.5.2 If the Engineer, or his designee, Owner or public authorities having jurisdiction determine that portions of the Work require additional testing, inspection or approval not included under Section 13.5.1, the Engineer, or his designee will, upon written authorization from the Owner, instruct the Contractor to make arrangements for such additional testing, inspection or approval by an entity acceptable to the Owner, and the Contractor shall give timely notice to the Engineer, or his designee of when and where tests and inspections are to be made so that the Engineer, or his designee may be present for such procedures. Such costs, except as provided in Section 13.5.3, shall be at the Owner's expense.

§ 13.5.3 If such procedures for testing, inspection or approval under Sections 13.5.1 and 13.5.2 reveal failure of the portions of the Work to comply with requirements established by the Contract Documents, all costs made necessary by such failure including those of repeated procedures and compensation for the Engineer, or his designee's services and expenses shall be at the Contractor's expense.

§ 13.5.4 Required certificates of testing, inspection or approval shall, unless otherwise required by the Contract Documents, be secured by the Contractor and promptly delivered to the Engineer, or his designee.

§ 13.5.5 If the Engineer, or his designee is to observe tests, inspections or approvals required by the Contract Documents, the Engineer, or his designee will do so promptly and, where practicable, at the normal place of testing.

§ 13.5.6 Tests or inspections conducted pursuant to the Contract Documents shall be made promptly to avoid unreasonable delay in the Work.

§ 13.6 INTEREST

Except as required by Section 5.1.3 of the Owner Contractor Agreement and notwithstanding anything to the contrary contained in the Contract Documents and related documents, the Owner will pay no interest whatsoever for any payments due.

§ 13.7 TIME LIMITS ON CLAIMS

Intentionally deleted.

ARTICLE 14 TERMINATION OR SUSPENSION OF THE CONTRACT

§ 14.1 TERMINATION BY THE CONTRACTOR

§ 14.1.1 The Contractor may terminate the Contract if the Work is stopped for a period of 30 consecutive days through no act or fault of the Contractor or a Subcontractor, Sub-subcontractor or their agents or employees or any other persons or entities performing portions of the Work under direct or indirect contract with the Contractor, for any of the following reasons:

- .1 Issuance of an order of a court or other public authority having jurisdiction that requires all Work to be stopped;
- .2 An act of government, such as a declaration of national emergency that requires all Work to be stopped;

§ 14.1.2 Intentionally deleted

§ 14.1.3 If one of the reasons described in Section 14.1.1 exists, the Contractor may, upon thirty (30) days' written notice to the Owner and Engineer, or his designee, terminate the Contract

§ 14.1.4 Intentionally deleted.

§ 14.2 TERMINATION BY THE OWNER FOR CAUSE

§ 14.2.1 The Owner may terminate the Contract if the Contractor after Notice and an opportunity to cure.

- .1 refuses or fails to supply enough properly skilled workers or proper materials;
- .2 fails to make payment to Subcontractors for materials or labor in accordance with the respective agreements between the Contractor and the Subcontractors;
- .3 disregards laws, ordinances, rules or regulations, or orders of a public authority having jurisdiction;
- .4 fails to furnish the Owner with assurances satisfactory to the Owner, evidencing the Contractor's ability to complete the Work in compliance with all requirements of the Contract Documents;
- .5 fails after commencement of the Work, to proceed continuously with the construction and completion of the Work, for more than three (3) days, except as permitted by the Contract Documents;
- .6 disregards orders of the Owner or Engineer, or his designee;
- .7 fails to maintain the Site in a clean, safe and orderly manner;
- .8 fails to comply with a Construction Change Directive; or
- .9 otherwise is guilty of any breach of a provision of the Contract Documents.

§ 14.2.2 When any of the above reasons exist, the Owner, upon certification by the Initial Decision Maker that sufficient cause exists to justify such action, may without prejudice to any other rights or remedies of the Owner and after giving the Contractor and the Contractor's surety, if any, seven days' written notice, terminate employment of the Contractor and may, subject to any prior rights of the surety:

- .1 Exclude the Contractor from the site and take possession of all materials, equipment, tools, and construction equipment and machinery thereon owned by the Contractor;
- .2 Accept assignment of subcontracts pursuant to Section 5.4; and
- .3 Finish the Work by whatever reasonable method the Owner may deem expedient. And charge the costs incurred against the Contractor's Contract balance

§ 14.2.3 When the Owner terminates the Contract for one of the reasons stated in Section 14.2.1, the Contractor shall not be entitled to receive further payment until the Work is finished. The Engineer, or his designee's certification issued pursuant to Section 14.2.2 shall be given a presumption of correctness.

§ 14.2.4 If the unpaid balance of the Contract Sum exceeds costs of finishing the Work, including compensation for the Engineer, or his designee's services and expenses made necessary thereby, and other damages incurred by the Owner and not expressly waived, such excess shall be paid to the Contractor. If such costs and damages exceed the unpaid balance, the Contractor shall pay the difference to the Owner. The amount to be paid to the Contractor or Owner, as the case may be, shall be certified by the Engineer, or his designee, upon application, and this obligation for payment shall survive termination of the Contract.

§ 14.3 SUSPENSION BY THE OWNER FOR CONVENIENCE

§ 14.3.1 The Owner may, without cause, order the Contractor in writing to suspend, delay or interrupt the Work in whole or in part for such period of time as the Owner may determine.

§ 14.3.2 Intentionally deleted.

§ 14.4 TERMINATION BY THE OWNER FOR CONVENIENCE

§ 14.4.1 The Owner may, at any time, terminate the Contract for the Owner's convenience and without cause.

§ 14.4.2 Upon receipt of written notice from the Owner of such termination for the Owner's convenience, the Contractor shall

- .1 cease operations as directed by the Owner in the notice;

- 2 take actions necessary, or that the Owner may direct, for the protection and preservation of the Work; and
- 3 except for Work directed to be performed prior to the effective date of termination stated in the notice, terminate all existing subcontracts and purchase orders and enter into no further subcontracts and purchase orders.

§ 14.4.3 In case of such termination for the Owner's convenience, the Contractor shall be entitled to receive payment for Work executed, and costs incurred by reason of such termination, along with reasonable overhead and profit on the Work not executed.

ARTICLE 15 CLAIMS AND DISPUTES

§ 15.1 CLAIMS

§ 15.1.1 DEFINITION

A Claim is a demand or assertion by one of the parties seeking adjustment or interpretation of Contract terms, payment of money, extension of time, or other relief with respect to the terms of the Contract. Any Contractor Claim seeking the payment of money shall not include consequential damages, which Contractor hereby waives, and shall be calculated in accordance with Section 7.3.6 and Section 7.3.10 hereof.

§ 15.1.2 DECISION OF ENGINEER, OR HIS DESIGNEE

Owner and Contractor agree that the Engineer, or his designee shall be the initial arbiter of all Claims, including those alleging error or omission by the Engineer, or his designee. All claims, shall be referred, initially to the Engineer, or his designee for action as provided in Article 4 and shall be required as a condition precedent to litigation of a Claim between the Contractor and Owner to all such matters arising prior to the date final payment is due, regardless of: (1) whether such matters relate to execution and progress of the Work; or (2) the extent to which the work has been completed. The decision by the Engineer, or his designee in response to a Claim shall not be a condition precedent to litigation in the event: (1) the position of the Engineer, or his designee is vacant; (2) the Engineer, or his designee has not received evidence or has failed to render a decision within agreed time limits; (3) the Engineer, or his designee has failed to take action required under Article 4 within thirty (30) days after the Claim is made; (4) forty-five (45) days have passed after the Claim has been referred to the Engineer, or his designee; or, (5) the claim relates to a mechanic's lien.

§ 15.1.3 TIME LIMITS ON CLAIMS

Claims must be within twenty one (21) calendar days after the occurrence of the event giving rise to the Claim or within twenty-one (21) calendar days after the claimant first becomes aware of the condition giving rise to the Claim, whichever is later. There shall be no time limitation upon any Claims made by the Owner. Claims must be made by written notice to the Engineer, or his designee. An additional Claim made after the initial Claim has been implemented by Change Order will not be considered unless submitted pursuant to the requirements of this Paragraph. Notice shall be deemed effective upon the Engineer, or his designee's receipt of the Notice.

§ 15.1.4 CONTINUING CONTRACT PERFORMANCE

Pending final resolution of a Claim, unless otherwise agreed in writing, the Contractor shall proceed diligently with performance of the Contract and the Owner shall continue to make payments to the extent required by the Contract Documents.

§ 15.1.5 CLAIMS FOR CONCEALED OR UNKNOWN CONDITIONS

If conditions are encountered at the Site which are: (1) subsurface or otherwise concealed physical conditions which differ materially from those indicated in the Contract Documents; or (2) unknown physical conditions of an unusual nature, which differ materially from those ordinarily found to exist and generally recognized as inherent in construction activities of the character provided for the Contract Documents, the Owner and Contractor mutually agree to give written notice to each other; including the Engineer, or his designee and any affected Contractor or subcontractor, upon the observation of the condition within twenty-four (24) hours of first observation of the condition. The Engineer, or his designee will investigate such conditions within seventy-two (72) hours and will diligently process and render a recommendation within twenty-one (21) days unless otherwise agreed in writing. If the Engineer, or his designee determines that the condition at the site are not materially different from those indicated in the Contract Documents and that no change in the terms of the Contract is justified the Engineer, or his designee shall so notify the Owner and Contractor in writing, stating the reasons. Claims by either party in

opposition to such determination must be made within seven (7) days after the Engineer, or his designee has given notice of the decision.

§ 15.1.6 CLAIMS FOR ADDITIONAL COST

If the Contractor wishes to make a Claim for an increase in the Contract Sum written notice as provided herein shall be given before proceeding to execute the Work. All documentation in support of the Contractor's request shall, likewise be provided at the time said written request is made. Prior notice is not required for Claims relating to an emergency endangering life or property arising under Section 10.3 or elsewhere in the Contract Documents.

§ 15.2 CLAIMS FOR ADDITIONAL TIME

§ 15.2.1 If the Contractor wishes to make a Claim for an increase in the Contract Time, written notice as provided herein shall be given. The Contractor's Claim shall include an estimate of cost and of probable effect of delay on progress of the Work, , all documentation in support of the Contractor's request shall, likewise be provided at the time said written request is made. In the case of a continuing delay, only one Claim is necessary.

§ 15.2.2 If adverse weather conditions are the basis for a Claim for additional time, such Claim shall be documented by data substantiating that weather conditions were abnormal for the period of time, could not have been reasonably anticipated and had an adverse effect on the scheduled construction. The term "abnormal" as used here shall be construed according to the following formula: average rainfall (or snow, low temperature, etc) for the past five (5) years for the month in question, plus ten percent (10%). Accordingly, weather is not deemed to be abnormal unless it is ten percent (10%) worse than the average for the month over the past five (5) years. Claims relating to weather must be submitted within seven (7) calendar days of the occurrence of any such delays.

§ 15.3 CLAIMS FOR INJURY OR DAMAGE TO PERSON OR PROPERTY. If either Party to the Contract suffers injury or damage to person or property because of an act or omission of the other party, of any of the other party's employees or agents, or of others for whose acts such party is legally liable, written notice of such injury or damage, whether or not insured, shall be given to the other party, including the Engineer, or his designee , within a reasonable time not exceeding twenty-one (21) days after first occurrence, unless another time period is required by law. The notice shall provide sufficient detail to enable the other party to investigate the matter. If a Claim for additional cost or time related to this Claim is to be asserted, it shall be filed as provided for in Article 15.

§ 15.3.2 The Owner is not required to institute a claim under this section in order to terminate this Agreement.

§ 15.4 RESOLUTION OF CLAIMS AND DISPUTES

The Engineer, or his designee will review Claims and take one or more of the following preliminary actions with ten (10) days of receipt of a Claim: (1) request additional supporting data from the claimant; (2) reject the Claim in who or in part, stating reasons for rejection ; (3) recommend approval of the Claim by other party; or (4) suggest a compromise.

§ 15.4.2 If a Claim has been resolved, the Engineer, or his designee will prepare or obtain appropriate documentation in consultation with Owner's counsel as circumstances dictate.

§ 15.4.3 If a Claim has not been resolved after consideration of the foregoing and of further evidence presented by the parties or requested by the Engineer, or his designee , the Engineer, or his designee will notify the parties in writing that the Engineer, or his designee 's decision will be made within seven (7) days, which decision shall be final. Upon expiration of such time period, the Engineer, or his designee will render to the parties the Engineer, or his designee 's written decision relative to the Claim, including any change in the Contract Sum or Contract Time or both.

§ 15.5. CLAIMS FORUM

Unless otherwise required by Section 5.1.3 of the Standard Form of Agreement between the Owner and Contractor, claims, disputes, or other matters in question between the parties to this Contract arising out of or relating to the Project or to this Contract, or the alleges breach thereof, shall be subject in the first instance to mediation and failing that, there in, a Court of competent jurisdiction venued in Union County, New Jersey. The Owner may not be compelled to submit any dispute concerning the Project to arbitration. By accepting award of the Contract and executing the Agreement, the Contractor consents to its joinder as a party in any litigation, mediation, arbitration or any other legal proceeding involving the Project and any references in the Contract documents.

§ 16.1 INTERPRETATIONS IN WRITING

§ 16.1.1 Neither the price bid for the work of any Contract, nor the Contract Sum, shall be based in any manner upon oral opinions, or real or alleged instructions of an oral nature, regardless if whether such opinions or instructions are expressed by the Owner, the Engineer, or his designee or its Consultants, the Contractor, or agents or representative of any of them and no such oral communication shall form the basis of a Claim.

§ 16.1.2 These provisions do not intend to deny, on an oral basis, normal discussion, recommendations, explanations, suggestions, approvals, rejections, and similar activity in pursuit of the work of the Project, such as at job conferences and otherwise at the Site. In such instances, the written minutes, correspondence, shop drawing records, written field orders, and other written data shall govern over personal claims regarding statements made contrary to the written data.

§ 17.1 JOB SITE MEETINGS

§ 17.1.1 Job site meetings, when called by the Engineer, or his designee, shall be held at a location and time convenient to the Owner's representatives, the Engineer, or his designee, and Contractor(s). Each Contractor shall attend such meeting, or be represented by a person in authority who is thoroughly familiar with the Project and who can speak and make decisions for the Contractor. In the instance of a Single Overall Contract, each of the major Subcontractors-Structural Steel, and ornamental iron work, plumbing, gas fitting and all kindered work and steam power plants, steam, and hot water heating and ventilating apparatus and Electrical-shall have a person in authority who is thoroughly familiar with the Project attend the meetings.

§ 18.1 MANDATORY LAW AGAINST DISCRIMINATION LANGUAGE
PROCUREMENT, PROFESSIONAL AND SERVICE CONTRACTS
(N.J.A.C. 13:6-1.3)

§ 18.1.1 The parties of this contract do hereby agree that the provision of N.J.S.A. 10:2-1 through N.J.S.A. 10:2-4 dealing with discrimination in employment on public contracts, and the rules and regulations promulgated pursuant thereto, are hereby made a part of this contract and are binding upon them.

§ 18.1.1 Pursuant to the provision of N.J.S.A. 10:2-1 through N.J.S.A. 10:2-4, during the performance of this contract, the Contractor agrees as follows:

§ 18.2.1.1 In the hiring of persons for the performance of work under this contract or any subcontract hereunder, or for the procurement, manufacture, assembling or furnishing of any such materials, equipment, supplies or services to be acquired under this contract, no Contractor, including without limitation, the Contractor, nor any person acting on behalf of such Contractor or subcontractor, shall by reason of race, creed, color national origin, ancestry, Marital status, gender identity or expression, affectional or sexual orientation, or sex, discriminate against any person who is qualified and available to perform the Work, to which the employment relates;

§ 18.2.1.2 No Contractor, including, without limitation, the Contractor, Subcontractor, nor any person acting on its behalf shall, in any manner, discriminate against or intimidate any employee engaged in the performance of work under this Contract or any subcontract hereunder, or engaged in the procurement, manufacture, assembling or furnishing of any such materials, equipment, supplies or services to be acquired under such Contract, on account of race, creed, color, national origin, ancestry, marital status, gender identity or expression, affectional or sexual orientation, or sex;

§ 18.2.1.3 There may be deducted from the amount payable to the Contractor by the Owner, under the Contract, a penalty of \$50.00 (fifty dollars) for each person for each calendar day during which such person is discriminated against or intimidated in violation of the provisions of the Contract; and

§ 18.2.1.4 This contract may be canceled or terminated by the Owner, and all the money due or to become due hereunder may be forfeited, for any violation of this section of the Contract occurring after notice to the Contractor from the contracting public agency or any prior violation of this section of the Contract.

§ 19.1 CONTRACTOR AND SUBCONTRACTOR COLLECTION OF USE TAX TO LOCAL GOVERNMENTS

§ 19.1.1 The Contractor acknowledges and agrees that pursuant to P.L. 2004, c. 57, enacted by the State of New Jersey on June 29, 2004, contractors or contractors with subcontractors, or their affiliates, who enter into contracts

with New Jersey local government entities, including without limitation, boards of education, are, effective as of September 1, 2004, required to collect and remit to the New Jersey Director of Taxation in the Department of the Treasury the use tax pursuant to the "sales and Use Tax Act," P.L. 1966, c. 30 (C.54:32B-1 et. seq.) on all their sales of tangible personal property delivered into the State of New Jersey (hereinafter referred to as the "Contractor Use Tax Collection Legislation").

§ 19.2.1 The Contractor hereby covenants and agrees that the Contractor, any subcontractor and each of their affiliates, shall collect and remit to the New Jersey Director of the Division of Taxation in the Department of Treasury, the use tax due pursuant to the "Sales and Use Tax Act," P.L. 1966, c. 30 (C.54:32B-1 et. seq.) on all their sales of tangible personal property delivered into the State of New Jersey. For purposes herein, "affiliate" shall mean any entity that : (a) directly, indirectly or constructively controls another entity; (b) is directly, indirectly, or constructively controlled by another entity; or (c) is subject to the control of a common entity. For purposes of the immediately preceding sentence, an entity controls another entity if it owns, directly or indirectly, more than fifty percent (50%) of the Ownership interest in that entity.

§ 19.3.1 The parties intend that this Article 19 shall comply with the rules and regulations promulgated pursuant to the Contractor Use Tax Collection Legislation and shall be interpreted consistent therewith.

§ 19.4 Notwithstanding anything contained in the Agreement to the contrary, the Contractor hereby agrees to indemnify and hold the Owner harmless from and against any and all fines, taxes, penalties, interest, claims, losses. Costs, expenses, liabilities, or damages arising out of or in connection with the Contractor's failure to comply with the terms and condition of Sections 19.1 and 19.2 to the fullest extent permitted by law and public policy.

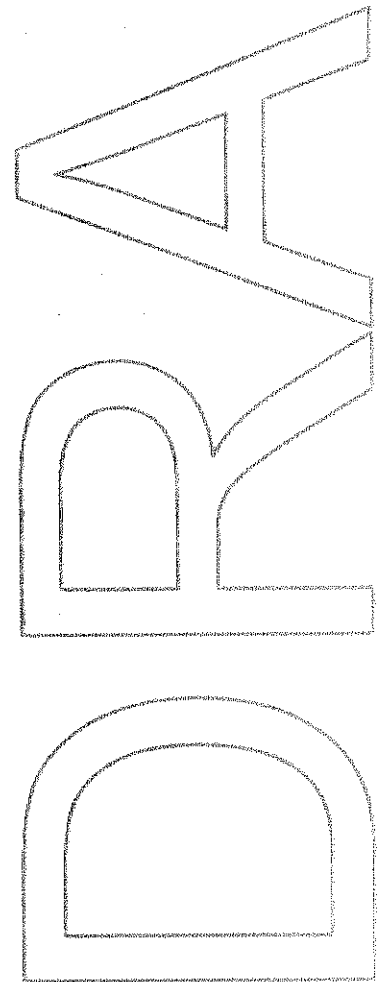



STATE OF NEW JERSEY
Department of Labor and Workforce Development
Division of Wage and Hour Compliance - Public Contracts Section
PO Box 389
Trenton, NJ 08625-0389

PREVAILING WAGE RATE DETERMINATION

The New Jersey Prevailing Wage Act (N.J.S.A. 34:11-56.25 et seq.) requires that the Department of Labor and Workforce Development establish and enforce a prevailing wage level for workers engaged in public works in order to safeguard their efficiency and general well being and to protect them as well as their employers from the effects of serious and unfair competition.

Prevailing wage rates are wage and fringe benefit rates based on the collective bargaining agreements established for a particular craft or trade in the locality in which the public work is performed. In New Jersey, these rates vary by county and by the type of work performed.

Applicable prevailing wage rates are those wages and fringe benefits in effect on the date the contract is awarded. All pre-determined rate increases listed at the time the contract is awarded must also be paid, beginning on the dates specified. Rates that have expired will remain in effect until new rates are posted.

Prevailing Wage Rate

The prevailing wage rate for each craft will list the effective date of the rate and the following information:

W = Wage Rate per Hour **B** = Fringe Benefit Rate per Hour* **T** = Total Rate per Hour

* Fringe benefits are an integral part of the prevailing wage rate. Employers not providing such benefits must pay the fringe benefit amount directly to the employee each payday. Employers providing benefits worth less than the fringe benefit amount must pay the balance directly to the employee each payday.

Unless otherwise stated in the Prevailing Wage Rate Determination, the fringe benefit rate for overtime hours remains at the straight time rate.

When the Overtime Notes in the Prevailing Wage Rate Determination state that the overtime rates are "inclusive of benefits," the benefit rate is increased by the same factor as the wage rate (i.e. multiplied by 1.5 for time and one-half, multiplied by 2 for double time, etc.).

Apprentice Rate Schedule

An "apprentice" is an individual who is registered with the United States Department of Labor - Office of Apprenticeship and enrolled in a certified apprenticeship program during the period in which they are working on the public works project.

The apprentice wage rate is a percentage of the journeyman wage rate, unless otherwise indicated. The apprentice benefit rate is the full journeyman benefit rate, unless otherwise indicated.

If there is no apprentice rate schedule listed, the individual must be paid at least the journeyman rate even if that individual is in a certified apprentice program for that trade.

If there is no ratio of apprentices to journeymen listed for a particular craft, then the ratio shall be one (1) apprentice to every four (4) journeymen.

Comments/Notes

For each craft listed there will be comments/notes that cover the definition of the regular workday, shift differentials, overtime, recognized holidays, and any other relevant information.

Public Works Contractor Registration

The Public Works Contractor Registration Act (N.J.S.A. 34:11-56.48, et seq.) requires that **all** contractors, subcontractors, or lower tier subcontractors who are working on or who bid on public works projects register with the Department of Labor and Workforce Development. Applications are available at www.nj.gov/labor (click on Wage & Hour and then go to Registration & Permits).

Pursuant to N.J.S.A. 34:11-56.51:

No contractor shall bid on any contract for public work as defined in section 2 of P.L.1963, c. 150 (C.34:11-56.26) unless the contractor is registered pursuant to this act. No contractor shall list a subcontractor in a bid proposal for the contract unless the subcontractor is registered pursuant to P.L.1999, c.238 (C.34:11-56.48 et seq.) at the time the bid is made. No contractor or subcontractor, including a subcontractor not listed in the bid proposal, shall engage in the performance of any public work subject to the contract, unless the contractor or subcontractor is registered pursuant to that act.

Snow Plowing

Snow plowing contracts are not subject to the New Jersey Prevailing Wage Act or the Public Works Contractor Registration Act.

**NEW JERSEY DEPARTMENT OF LABOR AND WORKFORCE DEVELOPMENT
PREVAILING WAGE RATE DETERMINATION**

County - UNION

Craft: Air Conditioning & Refrigeration - Service and Repair

PREVAILING WAGE RATE

	03/19/15
Journeyman (Mechanic)	W36.18 B21.10 T57.28

Expiration Date: 02/29/2016

Craft: Air Conditioning & Refrigeration - Service and Repair

APPRENTICE RATE SCHEDULE

INTERVAL	PERIOD AND RATES									
	Mo. 1-3	Mo. 4-12	2nd Year	3rd Year	4th Year	5th Year		Wage = %	of Jnymn	Wage
As Shown										
Wage and Bene	50%	55%	60%	65%	75%	85%		Bene = %	of Jnymn	Bene

Ratio of Apprentices to Journeymen - 1:4

APPRENTICE RATE SCHEDULE FOR THOSE APPRENTICES ENTERING PROGRAM AFTER 3-1-13:

INTERVAL	PERIOD AND RATES							
As Shown	1st Year	2nd Year	3rd Year	4th Year	5th Year		Wage =% of Jnymn Wage	
Wage and Benefit	40%	50%	60%	70%	80%		Bene. =% of Jnymn Wage	

Craft: Air Conditioning & Refrigeration - Service and Repair

COMMENTS/NOTES

THESE RATES MAY BE USED FOR THE FOLLOWING:

- Service/Repair/Maintenance Work to EXISTING facilities.
- Replacement or Installation of air conditioning and refrigeration equipment when the combined tonnage does not exceed 15 tons for refrigeration, or 25 tons for air conditioning.
- Replacement or Installation of "packaged" or "unitary" rooftop-type units when the combined tonnage of the units does not exceed 75 tons.

NOTE: These rates may NOT be used for any work in new construction (including work on new additions).

The regular workday shall consist of 8 hours, starting between 6:00 AM and 10:00 AM, Monday through Friday.

SHIFT DIFFERENTIALS:

- The second and third shifts shall be paid an additional 15% of the hourly rate.
- All shifts must run for a minimum of 5 consecutive days.

OVERTIME:

Hours worked in excess of 8 per day or before or after the regular workday, that are not shift work, and all hours on Saturday shall be paid at time and one-half the hourly rate, inclusive of benefits. All hours on Sunday and holidays shall be paid at double the hourly rate, inclusive of benefits.

RECOGNIZED HOLIDAYS: New Year's Day, Presidents' Day, Memorial Day, July 4th, Labor Day, Veterans' Day, Thanksgiving Day, Christmas Day.

**NEW JERSEY DEPARTMENT OF LABOR AND WORKFORCE DEVELOPMENT
PREVAILING WAGE RATE DETERMINATION**

County - UNION

Craft: Boilermaker PREVAILING WAGE RATE

	01/09/15
Foreman	W45.00 B40.02 T85.02
General Foreman	W47.00 B41.00 T88.00
Journeyman	W41.00 B38.42 T79.42

Expiration Date: 12/31/2015

Craft: Boilermaker APPRENTICE RATE SCHEDULE

INTERVAL	PERIOD AND RATES									
	65%	70%	75%	80%	85%	90%	95%			
1000 Hours										
Benefit =	32.33	33.20	34.08	34.94	35.82	36.69	37.55			

Ratio of Apprentices to Journeymen - *

* 1 apprentice will be allowed for the first 5 journeymen, 1 apprentice for the next 10 journeymen and 1 apprentice for each succeeding 20 journeymen up to a maximum of 5 apprentices per contractor on any one job.

Craft: Boilermaker COMMENTS/NOTES

HIGH WORK: All apprentices working on the erection, repair, or dismantling of smoke stacks, standpipes, or water towers shall be paid the Journeyman rate.

The regular workday shall consist of 8 hours, between 8:00 AM and 4:30 PM.

SHIFT DIFFERENTIALS:

- The second shift shall work 7½ hours and receive 8 hours pay, at a rate equal to the regular hourly rate plus 10%.
- The third shift shall work 7 hours and receive 8 hours pay, at a rate equal to the regular hourly rate plus 20%.
- For "Municipal Water Works" projects only, the following shall apply: Two, four day, 10 hour shifts may be worked at straight time Monday through Thursday. The day shift shall work four days, at 10 hours, for 10 hours pay. The second shift shall work four days, at nine and a half hours, for 10 hours pay, plus 10% the hourly rate for new work and .25 cents on repair work. Friday may be used as a make-up day at straight time, due to weather conditions, holiday or any other circumstances beyond the employer's control.

OVERTIME:

- Hours in excess of 8 per day, Monday through Friday, and all hours on Saturdays shall be paid at time and one-half the hourly rate. All hours on Sundays and holidays (except Labor Day) shall be paid at double the hourly rate. All hours on Labor Day shall be paid at four times the hourly rate.
- If any other craft employed by the same contractor, or a subcontractor thereof, receives double time in lieu of time and one-half, then the Boilermaker shall receive double time in lieu of time and one-half.
- For "Municipal Water Works" projects only, the following shall apply: Four 10 hour days may be worked Monday through

**NEW JERSEY DEPARTMENT OF LABOR AND WORKFORCE DEVELOPMENT
PREVAILING WAGE RATE DETERMINATION**

County - UNION

Thursday at straight time. Friday may be used as a make-up day for a day lost to inclement weather, holiday or other conditions beyond the control of the employer. Overtime shall be paid for any hours that exceed 10 hours per day or 40 hours per week.

RECOGNIZED HOLIDAYS: New Year's Day, Washington's Birthday, Memorial Day, July 4th, Labor Day, Presidential Election Day, Veterans' Day, Thanksgiving Day, Christmas Day. Sunday holidays observed the following Monday.

**NEW JERSEY DEPARTMENT OF LABOR AND WORKFORCE DEVELOPMENT
PREVAILING WAGE RATE DETERMINATION**

County - UNION

Craft: Boilermaker - Minor Repairs

PREVAILING WAGE RATE

	01/09/15
Foreman	W30.29 B16.17 T46.46
General Foreman	W30.79 B16.17 T46.96
Mechanic	W28.79 B16.17 T44.96

Expiration Date: 12/31/2015

Craft: Boilermaker - Minor Repairs

COMMENTS/NOTES

NOTE: These rates apply to MINOR REPAIR WORK ONLY (repair work in the field for which the contract amount does not exceed \$20,000.00).

OVERTIME:

Hours in excess of 8 per day, Monday through Friday, and all hours on Saturdays shall be paid at time and one-half the hourly rate. All hours on Sundays and holidays (except Labor Day) shall be paid at double the hourly rate. All hours on Labor Day shall be paid at four times the hourly rate.

RECOGNIZED HOLIDAYS: New Year's Day, Washington's Birthday, Good Friday, Memorial Day, July 4th, Labor Day, Presidential Election Day, Thanksgiving Day, day after Thanksgiving, Christmas Day. Saturday holidays observed the preceding Friday, Sunday holidays observed the following Monday.

**NEW JERSEY DEPARTMENT OF LABOR AND WORKFORCE DEVELOPMENT
PREVAILING WAGE RATE DETERMINATION**

County - UNION

Craft: Bricklayer, Stone Mason

PREVAILING WAGE RATE

	05/01/15
Deputy Foreman	W41.25 B29.83 T71.08
Foreman	W44.25 B29.83 T74.08
Journeyman	W38.25 B29.83 T68.08

Expiration Date: 04/30/2016

Craft: Bricklayer, Stone Mason

APPRENTICE RATE SCHEDULE

INTERVAL	PERIOD AND RATES									
6 Months	40%	50%	55%	60%	65%	70%	75%	80%		
Benefits	3.72	4.65	5.12	5.58	19.73	21.04	22.35	23.65		

Ratio of Apprentices to Journeymen - 1:5

Craft: Bricklayer, Stone Mason

COMMENTS/NOTES

The regular workday shall consist of 8 hours, between 6:00 AM and 4:30 PM.

SHIFT DIFFERENTIALS:

- When a 2 shift schedule (including a day shift) is established, the first, or day shift, shall be established on an 8 hour basis. The second shift shall be established on an 8 hour basis, and receive the regular rate plus 15%, inclusive of benefits.
- When a three shift schedule is established, the first shift shall be established on an 8 hour basis, the second shift on a 7.5 hour basis, and the third shift on a 7 hour basis. The first shift shall receive the regular hourly rate, the second shift shall receive the regular rate plus 15%, inclusive of benefits, and the third shift shall receive the regular rate plus 20%, inclusive of benefits.
- When there is no day shift, and a second or third shift is established, it shall be established on an 8 hour basis. The second shift shall receive the regular rate plus 15%, inclusive of benefits, and the third shift shall receive the regular rate plus 20%, inclusive of benefits.

OVERTIME:

- The first 2 hours in excess of 8 per day, or before or after the regular workday that are not shift work, Monday through Friday, shall be paid at time and one-half the regular rate, inclusive of benefits. Any additional overtime shall be paid at double the regular rate, inclusive of benefits. The first 10 hours on Saturday shall be paid at time and one-half the regular rate, inclusive of benefits. Any additional overtime shall be paid at double the regular rate, inclusive of benefits. All hours on Sundays and holidays shall be paid at double the regular rate, inclusive of benefits.
- Saturday may be used as a make-up day for hours lost to inclement weather.
- When Bricklayers/Stone Masons work on Saturday with Laborers, and no other crafts are working on the project for the day, benefits may be paid at straight time. If other crafts are present, the applicable overtime rate for benefits shall be paid.

**NEW JERSEY DEPARTMENT OF LABOR AND WORKFORCE DEVELOPMENT
PREVAILING WAGE RATE DETERMINATION**

County - UNION

RECOGNIZED HOLIDAYS: New Year's Day, Presidents' Day, Memorial Day, July 4th, Labor Day, Presidential Election Day, Veterans' Day, Thanksgiving Day, Christmas Day. Sunday holidays will be observed the following Monday.

**NEW JERSEY DEPARTMENT OF LABOR AND WORKFORCE DEVELOPMENT
PREVAILING WAGE RATE DETERMINATION**

County - UNION

Craft: Carpenter PREVAILING WAGE RATE

	05/12/15	11/01/15
Foreman	W51.22 B28.68 T79.90	W0.00 B0.00 T80.42
Journeyman	W44.54 B24.94 T69.48	W0.00 B0.00 T70.73

Expiration Date: 04/30/2016

Craft: Carpenter APPRENTICE RATE SCHEDULE

INTERVAL	PERIOD AND RATES									
	40%	45%	50%	55%	60%	65%	70%	75%	85%	95%
6 Months										
Benefit	56% of	Appren	tice	Wage	Rate		for all	intervals		

Ratio of Apprentices to Journeymen - 1:4

Craft: Carpenter COMMENTS/NOTES

FOREMAN REQUIREMENTS:

- When there are 2 or more Carpenters on a job, 1 shall be designated as a Foreman.
- When there are 21 or more Carpenters on a job, 2 shall be designated as Foremen.

The regular workday shall consist of 8 hours, starting between 7:00 AM and 9:00 AM.

SHIFT DIFFERENTIALS:

- When a 2 shift schedule (including a day shift) is established, the day shift shall be established on an 8 hour basis. The second shift shall be established on an 8 hour basis, and receive the regular rate plus 15%, inclusive of benefits.
- When a three shift schedule is established, the first shift shall be established on an 8 hour basis, the second shift on a 7.5 hour basis, and the third shift on a 7 hour basis. The first shift shall receive the regular hourly rate, the second shift shall receive the regular rate plus 15% and the third shift shall receive the regular rate plus 20%, inclusive of benefits.
- When there is no day shift, and a second or third shift is established, it shall be established on an 8 hour basis. The second shift shall receive the regular rate plus 15% and the third shift shall receive the regular rate plus 20%, inclusive of benefits.

OVERTIME:

- All hours in excess of 8 per day, or before or after an established shift that are not shift work, and all hours on Saturdays shall be paid at time and one-half the hourly rate, inclusive of benefits. All hours on Sundays and holidays shall be paid at double the hourly rate, inclusive of benefits.
- Four 10-hour days may be worked, Monday to Thursday, at straight time. Friday may be used as a make-up day for a day lost due to inclement weather. If Friday is not a make-up day, all hours on Friday shall be paid at time and one-half the hourly rate, inclusive of benefits.

RECOGNIZED HOLIDAYS: New Year's Day, Presidents' Day, Memorial Day, July 4th, Labor Day, Presidential Election

**NEW JERSEY DEPARTMENT OF LABOR AND WORKFORCE DEVELOPMENT
PREVAILING WAGE RATE DETERMINATION**

County - UNION

Day, Veterans' Day, Thanksgiving Day, Christmas Day. Sunday holidays observed the following Monday.

**NEW JERSEY DEPARTMENT OF LABOR AND WORKFORCE DEVELOPMENT
PREVAILING WAGE RATE DETERMINATION**

County - UNION

Craft: Carpenter - Resilient Flooring

PREVAILING WAGE RATE

	05/12/15
Foreman	W51.22 B28.68 T79.90
Journeyman	W44.54 B24.94 T69.48

Expiration Date: 10/31/2015

Craft: Carpenter - Resilient Flooring

APPRENTICE RATE SCHEDULE

INTERVAL	PERIOD AND RATES									
6 Months	40%	45%	50%	55%	60%	65%	70%	75%	85%	95%
Benefit	56%	of	Appren	tice	Wage	Rate		for all	intervals	

Ratio of Apprentices to Journeymen - *

* 1 apprentice shall be allowed to every 2 journeymen or major fraction thereof. No more than 3 apprentices on any one job or project.

Craft: Carpenter - Resilient Flooring

COMMENTS/NOTES

FOREMAN REQUIREMENTS:

- On any job where there are 4 or more Carpenters of Resilient Flooring, 1 must be designated a Foreman.

FOR SYNTHETIC TURF INSTALLATION ONLY:

- The rate shall be 90% of the wage and benefit rate.

The regular workday consists of 8 hours, starting between 6:00 AM and 9:00 AM.

SHIFT DIFFERENTIALS:

- When a 2 shift schedule (including a day shift) is established, the day shift, shall be established on an 8 hour basis. The second shift shall be established on an 8 hour basis, and receive the regular wage rate plus 15%.
- When a three shift schedule is established, the first shift shall be established on an 8 hour basis, the second shift on a 7.5 hour basis, and the third shift on a 7 hour basis. The first shift shall receive the regular wage rate, the second shift shall receive the regular wage rate plus 15% and the third shift shall receive the regular wage rate plus 20%.
- When there is no day shift, and a second or third shift is established, it shall be established on an 8 hour basis. The second shift shall receive the regular wage rate plus 15% and the third shift shall receive the regular wage rate plus 20%.

OVERTIME:

- Hours in excess of 8 per day or 40 per week, or before or after the regular workday, Monday through Friday, shall be paid at time and one-half the wage rate. Saturday may be used as a make-up day, at straight time, up to 8 hours, for hours lost to reasons beyond the control of the employer, up to a total of 40 hours per week; hours in excess of 8 on Saturday shall then be paid at time and one-half the wage rate. If Saturday is not a make-up day, all hours on Saturday shall be paid at time and one-half the wage rate. All hours on Sundays and holidays shall be paid at double the wage rate.
- Four 10-hour days may be worked, Monday to Thursday, at straight time. Friday may be used as a make-up day for hours lost to reasons beyond the control of the employer. If Friday is not a make-up day, all hours on Friday shall be paid at time and one-half the wage rate.

**NEW JERSEY DEPARTMENT OF LABOR AND WORKFORCE DEVELOPMENT
PREVAILING WAGE RATE DETERMINATION**

County - UNION

RECOGNIZED HOLIDAYS: New Year's Day, Presidents' Day, Memorial Day, July 4th, Labor Day, Presidential Election Day, Veterans' Day, Thanksgiving Day, Christmas Day. Sunday holidays will be observed the following Monday.

**NEW JERSEY DEPARTMENT OF LABOR AND WORKFORCE DEVELOPMENT
PREVAILING WAGE RATE DETERMINATION**

County - UNION

Craft: Cement Mason

PREVAILING WAGE RATE

See "Bricklayer, Stone Mason" Rates

Expiration Date:

Craft: Cement Mason

APPRENTICE RATE SCHEDULE

INTERVAL	PERIOD AND RATES									

Ratio of Apprentices to Journeymen - 1:4

Craft: Cement Mason

COMMENTS/NOTES

See "Bricklayer, Stone Mason" Rates

**NEW JERSEY DEPARTMENT OF LABOR AND WORKFORCE DEVELOPMENT
PREVAILING WAGE RATE DETERMINATION**

County - UNION

Craft: Diver **PREVAILING WAGE RATE**

	05/01/15	11/01/15
Diver	W54.84	W0.00
	B42.32	B0.00
	T97.16	T98.41
Tender	W42.88	W0.00
	B42.32	B0.00
	T85.20	T86.45

Expiration Date: 04/30/2016

Craft: Diver **COMMENTS/NOTES**

NOTE: All dive crews must consist of a Tender, a Diver, and a standby Diver (standby Diver is the same rate as a Diver).

DEPTH & PENETRATION RATES: Divers shall be paid the following depth and penetration rates, in addition to the regular hourly rate, when applicable:

AIR DIVES:

0-59 feet: No additional wage
60-74 feet: + \$0.25 per foot
5-125 feet: + \$0.78 per foot
126-200 feet: + \$1.60 per foot

MIXED GAS DIVES:

0-74 feet: No additional wage
75-125 feet: + \$1.00 per foot
126-200 feet: + \$2.00 per foot

PENETRATION DIVES:

126-200 feet: + \$1.50 per foot
201-275 feet: + \$1.75 per foot
276-350 feet: + \$2.00 per foot
351-425 feet: + \$2.50 per foot

OVERTIME:

Hours in excess of 8 per day, Monday through Friday, and all hours on Saturdays shall be paid at time and one-half the hourly rate. All hours on Sundays and holidays shall be paid at double the hourly rate.

RECOGNIZED HOLIDAYS: New Year's Day, Presidents' Day, Memorial Day, July 4th, Labor Day, Veterans' Day, Presidential Election Day, Thanksgiving Day, Christmas Day. Veterans' Day may be switched with the day after Thanksgiving.

**NEW JERSEY DEPARTMENT OF LABOR AND WORKFORCE DEVELOPMENT
PREVAILING WAGE RATE DETERMINATION**

County - UNION

Craft: Dockbuilder PREVAILING WAGE RATE

	05/01/15	11/01/15
Foreman	W49.57 B42.32 T91.89	W0.00 B0.00 T93.14
Foreman (Concrete Form Work)	W49.57 B34.48 T84.05	W0.00 B0.00 T85.30
Journeyman	W43.10 B42.32 T85.42	W0.00 B0.00 T86.67
Journeyman (Concrete Form Work)	W43.10 B34.48 T77.58	W0.00 B0.00 T78.83

Expiration Date: 04/30/2016

Craft: Dockbuilder APPRENTICE RATE SCHEDULE

<u>INTERVAL</u>	<u>PERIOD AND RATES</u>									
Yearly	17.24	21.55	28.02	34.48						
Benefit	28.90	for all	intervals		Concrete	Form Work	Only Ben.	= 23.65	for all	intervals

Ratio of Apprentices to Journeymen - *

* When there are 4 or fewer Dockbuilders on a job, no more than 1 may be an apprentice. When there are 5 or more Dockbuilders, there may be 1 apprentice for every 5 Dockbuilders.

Craft: Dockbuilder COMMENTS/NOTES

CREOSOTE HANDLING:

When handling creosote products on land piledriving, floating marine construction, and construction of wharves, the worker shall receive an additional \$0.25 per hour.

HAZARDOUS WASTE WORK:

- Hazardous waste removal work on a state or federally designated hazardous waste site where Level A, B, or C personal protection is required: an additional 20% of the hourly rate, per hour.
- Hazardous waste removal work in Level D, or where personal protection is not required: an additional \$1.00 per hour.

CERTIFIED WELDER: When required on the job by the project owner, a Certified Welder shall receive an additional \$1.00 per hour.

FOREMAN REQUIREMENTS:

The first Dockbuilder on the job shall be designated a Foreman.

OVERTIME:

Hours in excess of 8 per day, Monday through Friday, and all hours on Saturdays shall be paid at time and one-half the

**NEW JERSEY DEPARTMENT OF LABOR AND WORKFORCE DEVELOPMENT
PREVAILING WAGE RATE DETERMINATION**

County - UNION

hourly rate. All hours on Sundays and holidays shall be paid at double the hourly rate.

RECOGNIZED HOLIDAYS: New Year's Day, Presidents' Day, Memorial Day, July 4th, Labor Day, Veterans' Day, Presidential Election Day, Thanksgiving Day, Christmas Day. Veterans' Day may be switched with the day after Thanksgiving.

**NEW JERSEY DEPARTMENT OF LABOR AND WORKFORCE DEVELOPMENT
PREVAILING WAGE RATE DETERMINATION**

County - UNION

Craft: Drywall Finisher

PREVAILING WAGE RATE

	05/04/15	05/01/16	05/01/17
Foreman	W41.80 B22.60 T64.40	W43.05 B22.60 T65.65	W44.30 B22.60 T66.90
General Foreman	W43.70 B22.60 T66.30	W44.95 B22.60 T67.55	W46.20 B22.60 T68.80
Journeyman	W38.00 B22.60 T60.60	W39.25 B22.60 T61.85	W40.50 B22.60 T63.10

Expiration Date: 04/30/2018

Craft: Drywall Finisher

APPRENTICE RATE SCHEDULE

INTERVAL	PERIOD AND RATES									
	30%	40%	50%	60%	70%	75%	80%	85%	90%	
4 Months										
Benefits	Intervals	1 to 3 =	9.85	Intervals	4 to 6 =	12.28	Intervals	7 to 9 =	14.95	

Ratio of Apprentices to Journeymen - 1:4

Craft: Drywall Finisher

COMMENTS/NOTES

The regular workday shall consist of 8 hours between 7:00 AM and 5:30 PM.

SHIFT DIFFERENTIALS:

- The second shift shall receive an additional 10% of the hourly rate, per hour, and the third shift shall receive an additional 15% of the hourly rate, per hour.
- When 3 shifts are worked, the second shift shall receive 8 hours pay for 7.5 hours of work, and the third shift shall receive 8 hours pay for 7 hours of work.
- Shift work must run for a minimum of 5 consecutive workdays.

OVERTIME:

- Hours in excess of 8 per day, Monday through Friday, and all hours on Saturdays shall be paid at time and one-half the regular rate, inclusive of benefits. All hours on Sundays and holidays shall be paid at double the regular rate, inclusive of benefits.
- Saturday or Sunday may be used to make up a day lost to inclement weather, at straight time.

RECOGNIZED HOLIDAYS: New Year's Day, Memorial Day, July 4th, Labor Day, Presidential Election Day, Veterans' Day, Thanksgiving Day, Christmas Day. Saturday holiday observed the preceding Friday. Sunday holiday observed the following Monday.

**NEW JERSEY DEPARTMENT OF LABOR AND WORKFORCE DEVELOPMENT
PREVAILING WAGE RATE DETERMINATION**

County - UNION

Craft: Electrician

PREVAILING WAGE RATE

	06/02/15	05/30/16	05/29/17	05/28/18
Cable Splicer	W57.52 B32.88 T90.40	W58.71 B33.74 T92.45	W60.08 B34.53 T94.61	W61.52 B35.35 T96.87
Foreman	W58.56 B33.47 T92.03	W59.77 B34.34 T94.11	W61.17 B35.15 T96.32	W62.64 B35.98 T98.62
Journeyman	W52.29 B29.90 T82.19	W53.37 B30.67 T84.04	W54.62 B31.39 T86.01	W55.93 B32.13 T88.06

Expiration Date: 05/31/2019

Craft: Electrician

APPRENTICE RATE SCHEDULE

INTERVAL	PERIOD AND RATES									
	40%	49%	58%	68%	80%		of Jour	neyman	Wage	Rate
Yearly	40%	49%	58%	68%	80%		of Jour	neyman	Wage	Rate
Benefit	40%	49%	58%	68%	80%		of Jour	neyman	Benefit	Rate

Ratio of Apprentices to Journeymen - 2:3

Craft: Electrician

COMMENTS/NOTES

THESE RATES ALSO APPLY TO THE FOLLOWING:

- All burglar and fire alarm work.
- All fiber optic work.
- Teledata work in new construction.
- Teledata work involving 16 Voice/Data Lines or more.

The regular workday shall be 8 hours, between 8:00 AM and 4:30 PM.

FOREMAN REQUIREMENTS:

- On any job where there are 1 to 10 Journeymen electricians, 1 shall be designated a Foreman.

SHIFT DIFFERENTIALS:

- Shift work must run for a minimum of 5 consecutive workdays.
- 2nd Shift (4:30 PM to 12:30 AM) shall receive 8 hours pay for 7.5 hours work + an additional 10% of the regular rate, per hour, inclusive of benefits.
- 3rd Shift (12:30 AM to 8:00 AM) shall receive 8 hours pay for 7 hours work + an additional 15% of the regular rate, per hour, inclusive of benefits.

OVERTIME:

Hours in excess of 8 per day, or outside of the regular workday, Monday through Friday, and all hours on Saturdays, shall be paid at time and one-half the regular rate, inclusive of benefits. All hours on Sundays and holidays shall be paid at double the regular rate, inclusive of benefits.

**NEW JERSEY DEPARTMENT OF LABOR AND WORKFORCE DEVELOPMENT
PREVAILING WAGE RATE DETERMINATION**

County - UNION

RECOGNIZED HOLIDAYS: New Year's Day, Presidents' Day, Memorial Day, July 4th, Labor Day, Presidential Election Day, Veterans' Day, Thanksgiving Day, Christmas Day.

**NEW JERSEY DEPARTMENT OF LABOR AND WORKFORCE DEVELOPMENT
PREVAILING WAGE RATE DETERMINATION**

County - UNION

Craft: Electrician - Teledata (15 Voice/Data Lines & Less)

PREVAILING WAGE RATE

	12/04/14
Master Technician/General Foreman	W49.84 B28.49 T78.33
Senior Technician/Lead Foreman (21-30 Workers on Job)	W45.62 B26.08 T71.70
Technician A/Foreman (11-20 Workers on Job)	W43.71 B24.99 T68.70
Technician B/Working Foreman (4-10 Workers on Job)	W41.79 B23.89 T65.68
Technician C/Journeyman (1-3 Workers on Job)	W38.34 B21.92 T60.26

Expiration Date: 11/01/2015

Craft: Electrician - Teledata (15 Voice/Data Lines & Less)

APPRENTICE RATE SCHEDULE

INTERVAL	PERIOD AND RATES									
6 Months	19.20	20.48	22.62	25.18	28.16	30.72	33.71	36.70		
Benefits	7.96	8.49	9.38	10.44	11.68	12.74	13.98	15.22		

Ratio of Apprentices to Journeymen - 2:3

Craft: Electrician - Teledata (15 Voice/Data Lines & Less)

COMMENTS/NOTES

APPRENTICE RATE SCHEDULE FOR THOSE APPRENTICES ENTERING PROGRAM AFTER 10-31-14:

INTERVAL	PERIOD AND RATES								
6 Months	17.07	18.35	20.48	23.04	26.03	28.59	31.58	34.56	
Benefits	7.08	7.61	8.49	9.56	10.79	11.86	13.09	14.33	

NOTES:

- These rates are for service, maintenance, moves, and/or changes affecting 15 Voice/Data (teledata) lines or less. These rates may NOT be used for any teledata work in new construction (including additions) or any fiber optic work.
- The number of Teledata workers on the jobsite is the determining factor for which Foreman category applies.

The regular workday shall be 8 hours, between 8:00 AM and 4:30 PM.

SHIFT DIFFERENTIALS:

**NEW JERSEY DEPARTMENT OF LABOR AND WORKFORCE DEVELOPMENT
PREVAILING WAGE RATE DETERMINATION**

County - UNION

- Shift work must run for a minimum of 5 consecutive workdays.
- 2nd Shift (4:30 PM to 12:30 AM) shall receive 8 hours pay for 7.5 hours work + an additional 10% of the regular rate, per hour, inclusive of benefits.
- 3rd Shift (12:30 AM to 8:00 AM) shall receive 8 hours pay for 7 hours work + an additional 15% of the regular rate, per hour, inclusive of benefits.

OVERTIME:

Hours in excess of 8 per day, or outside of the regular workday, Monday through Friday, and all hours on Saturdays, shall be paid at time and one-half the regular rate, inclusive of benefits. All hours on Sundays and holidays shall be paid at double the regular rate, inclusive of benefits.

RECOGNIZED HOLIDAYS: New Year's Day, Presidents' Day, Memorial Day, July 4th, Labor Day, Presidential Election Day, Veterans' Day, Thanksgiving Day, Christmas Day.

NEW JERSEY DEPARTMENT OF LABOR AND WORKFORCE DEVELOPMENT
PREVAILING WAGE RATE DETERMINATION

County - UNION

Craft: Electrician - Teledata (16 Instruments & More)

PREVAILING WAGE RATE

See "Electrician" Rates

Expiration Date:

Craft: Electrician - Teledata (16 Instruments & More)

COMMENTS/NOTES

See ELECTRICIAN Rates

**NEW JERSEY DEPARTMENT OF LABOR AND WORKFORCE DEVELOPMENT
PREVAILING WAGE RATE DETERMINATION**

County - UNION

Craft: Electrician- Outside Commercial

PREVAILING WAGE RATE

	08/20/15	05/30/16	05/29/17	05/28/18
Cable Splicer	W57.79 B32.60 T90.39	W58.99 B33.46 T92.45	W60.37 B34.24 T94.61	W61.82 B35.06 T96.88
Certified Welder	W55.17 B31.13 T86.30	W56.31 B31.94 T88.25	W57.62 B32.68 T90.30	W59.01 B33.47 T92.48
Equipment Operator	W52.54 B29.64 T82.18	W53.63 B30.42 T84.05	W54.88 B31.13 T86.01	W56.20 B31.88 T88.08
Foreman (1-10 Journeyman workers on job)	W58.84 B33.20 T92.04	W60.07 B34.07 T94.14	W61.47 B34.86 T96.33	W62.94 B35.70 T98.64
Foreman (11-20 Journeyman workers on job)	W60.42 B34.09 T94.51	W61.67 B34.98 T96.65	W63.11 B35.79 T98.90	W64.63 B36.66 T101.29
General Foreman (21-30 Journeyman workers on job)	W62.00 B34.98 T96.98	W63.28 B35.89 T99.17	W64.76 B36.73 T101.49	W66.32 B37.61 T103.93
General Foreman (31-60 Journeyman workers on job)	W67.25 B37.94 T105.19	W68.65 B38.94 T107.59	W70.25 B39.84 T110.09	W71.94 B40.80 T112.74
General Foreman (61+ Journeyman workers on job)	W68.30 B38.53 T106.83	W69.72 B39.54 T109.26	W71.34 B40.46 T111.80	W73.06 B41.44 T114.50
Groundman	W31.52 B17.79 T49.31	W32.18 B18.26 T50.44	W32.93 B18.68 T51.61	W33.72 B19.13 T52.85
Journeyman Lineman/Technician	W52.54 B29.64 T82.18	W53.63 B30.42 T84.05	W54.88 B31.13 T86.01	W56.20 B31.88 T88.08
Sub-Foreman	W58.84 B33.20 T92.04	W60.07 B34.07 T94.14	W61.47 B34.86 T96.33	W62.94 B35.70 T98.64

Expiration Date: 05/31/2019

**NEW JERSEY DEPARTMENT OF LABOR AND WORKFORCE DEVELOPMENT
PREVAILING WAGE RATE DETERMINATION**

County - UNION

Craft: Electrician- Outside Commercial

APPRENTICE RATE SCHEDULE

INTERVAL	PERIOD AND RATES									
1000 Hours	60%	65%	70%	75%	80%	85%	90%			
Benefits	56.4% of	Journey	man	wage	+.01					

Craft: Electrician- Outside Commercial

COMMENTS/NOTES

EFFECTIVE 5-30-16- The apprentice benefit rate shall be 56.7% + \$.01.
 EFFECTIVE 5-29-17- The apprentice benefit rate shall be 56.7% + \$.01.
 EFFECTIVE 5-28-18- The apprentice benefit rate shall be 56.7% + \$.01.

* FOR UTILITY WORK PLEASE SEE STATEWIDE RATES

The regular worday shall be 8 hours, between 8:00 AM and 4:30 PM.

FOREMAN REQUIREMENTS:

On jobs where there are 2 Journeymen, one shall be a Foreman. The following number of Foreman, General Foreman, Assistant General Foreman and Sub-Foreman shall be required with respect to number of Journeymen on site:

- 2-10 Journeymen (1 Foreman)
- 11-20 Journeymen (1 Foreman and 1 Sub-Foreman)
- 21-30 Journeymen (1 Foreman and 2 Sub-Foremen)

SHIFT DIFFERENTIALS:

- Shift work must run for a minimum of 5 consecutive workdays.
- 2nd Shift (4:30 PM to 12:30 AM): 8 hrs. pay for 7.5 hrs. work + an additional 10% of the regular rate, inclusive of benefits.
- 3rd Shift (12:30 AM to 8:00 AM): 8 hrs. pay for 7 hrs. work + an additional 15% of the regular rate per hour, inclusive benefits.

OVERTIME:

Hours in excess of 8 per day, or outside of the regular workday, Monday through Friday, and all hours on Saturdays, shall be paid at time and one-half the regular rate, inclusive of benefits. All hours on Sundays and holidays shall be paid at double the regular rate, inclusive of benefits.

RECOGNIZED HOLIDAYS:

New Year's Day, Presidents' Day, Memorial Day, July 4th, Labor Day, Presidential Election Day, Veterans' Day, Thanksgiving Day and Christmas Day.

**NEW JERSEY DEPARTMENT OF LABOR AND WORKFORCE DEVELOPMENT
PREVAILING WAGE RATE DETERMINATION**

County - UNION

Craft: Electrician-Utility Work (North)

PREVAILING WAGE RATE

Rates are located in the "Statewide" rate package

Expiration Date:

Craft: Electrician-Utility Work (North)

APPRENTICE RATE SCHEDULE

INTERVAL	PERIOD AND RATES									
6 Months	60%	65%	70%	75%	80%	85%	90%			
Benefits	62.5% of	Appren	tice	Wage	Rate	for all	intervals			

Craft: Electrician-Utility Work (North)

COMMENTS/NOTES

Electrician-Utility Work (North) rates are located in the "Statewide" rate package.

**NEW JERSEY DEPARTMENT OF LABOR AND WORKFORCE DEVELOPMENT
PREVAILING WAGE RATE DETERMINATION**

County - UNION

Craft: Electrician-Utility Work (South)

PREVAILING WAGE RATE

Rates are located in the "Statewide" rate package

Expiration Date:

Craft: Electrician-Utility Work (South)

APPRENTICE RATE SCHEDULE

INTERVAL	PERIOD AND RATES									
6 Months	26.27	28.46	30.65	32.84	35.03	37.22	39.41			
Benefits	21.83	23.08	24.32	25.57	26.81	28.06	29.32			

Craft: Electrician-Utility Work (South)

COMMENTS/NOTES

Electrician-Utility Work (South) rates are located in the "Statewide" rate package.

**NEW JERSEY DEPARTMENT OF LABOR AND WORKFORCE DEVELOPMENT
PREVAILING WAGE RATE DETERMINATION**

County - UNION

Craft: Elevator Constructor

PREVAILING WAGE RATE

	03/27/15	03/17/16	03/17/17	03/17/18
Journeyman	W59.55	W60.96	W62.64	W64.48
	B38.02	B39.77	B41.56	B43.36
	T97.57	T100.73	T104.20	T107.84

Expiration Date: 03/16/2019

Craft: Elevator Constructor

APPRENTICE RATE SCHEDULE

INTERVAL	PERIOD AND RATES									
	Yearly	26.62	32.75	38.71	44.66					
Benefits	30.23	31.32	32.81	34.30						

Ratio of Apprentices to Journeymen - 1:1

Craft: Elevator Constructor

COMMENTS/NOTES

The regular workday shall consist of either 7 or 8 hours to be established at the beginning of the project, between 7:00 AM and 4:30 PM.

OVERTIME:

For all hours worked before or after the regular workday, Monday through Friday, and all hours on Saturday and Sunday, shall be paid at double the hourly rate. Holiday pay is one days wages (8 hours) plus double the hourly rate for all hours worked.

RECOGNIZED HOLIDAYS: New Year's Day, Presidents' Day, Good Friday, Memorial Day, July 4th, Labor Day, Columbus Day, Veterans' Day, Thanksgiving Day and the day after, Christmas Day. Saturday holidays shall be observed on the previous Friday and Sunday holidays shall be observed on the following Monday.

**NEW JERSEY DEPARTMENT OF LABOR AND WORKFORCE DEVELOPMENT
PREVAILING WAGE RATE DETERMINATION**

County - UNION

Craft: Elevator Modernization & Service

PREVAILING WAGE RATE

	03/27/15	03/17/16	03/17/17	03/17/18
Journeyman	W46.92	W47.91	W49.14	W50.49
	B36.46	B38.17	B39.91	B41.66
	T83.38	T86.08	T89.05	T92.15

Expiration Date: 03/16/2019

Craft: Elevator Modernization & Service

APPRENTICE RATE SCHEDULE

INTERVAL	PERIOD AND RATES									
	Yearly	26.62	25.81	30.50	35.19					
Benefits	30.16	30.47	31.80	33.13						

Ratio of Apprentices to Journeymen - 1:1

Craft: Elevator Modernization & Service

COMMENTS/NOTES

MODERNIZATION (addition, replacement, refurbishing, relocation, or changes in design or appearance, of elevator equipment in existing buildings):

- The regular workday consists of 8 hours, between 7:00 AM and 4:30 PM.

- Overtime:

Hours in excess of 8 per day, or before or after the regular workday, Monday through Friday, and all hours on Saturday and Sunday shall be paid at time and one-half the hourly rate. Holiday pay is one days wages (8 hours) plus time and one-half the hourly rate for all hours worked.

SERVICE (repair or replacement of parts for the purpose of maintaining elevator equipment in good operating condition):

- The regular workday consists of 8 hours, between 6:00 AM and 6:00 PM.

- Overtime:

Hours in excess of 8 per day, or before or after the regular workday, Monday through Friday, and all hours on Saturday shall be paid at time and one-half the hourly rate. All hours on Sunday and holidays shall be paid at double the hourly rate.

RECOGNIZED HOLIDAYS (Modernization and Service): New Year's Day, Presidents' Day, Good Friday, Memorial Day, July 4th, Labor Day, Columbus Day, Veterans' Day, Thanksgiving Day and the day after, Christmas Day. Saturday holidays shall be observed on the previous Friday and Sunday holidays shall be observed on the following Monday.

**NEW JERSEY DEPARTMENT OF LABOR AND WORKFORCE DEVELOPMENT
PREVAILING WAGE RATE DETERMINATION**

County - UNION

Craft: Glazier PREVAILING WAGE RATE

	06/11/15	05/01/16
Foreman	W46.50 B22.65 T69.15	W0.00 B0.00 T70.65
General Foreman	W48.50 B22.89 T71.39	W0.00 B0.00 T72.89
Journeyman	W42.50 B22.17 T64.67	W0.00 B0.00 T66.17

Expiration Date: 04/30/2017

Craft: Glazier APPRENTICE RATE SCHEDULE

INTERVAL	PERIOD AND RATES									
	30%	40%	50%	60%	70%	75%	80%	85%	90%	
4 Months										
Benefits	Intervals	1 to 3 =	6.51	Intervals	4 to 6 =	9.33	Intervals	7 to 9 =	11.67	

Ratio of Apprentices to Journeymen - 1:4

Craft: Glazier COMMENTS/NOTES

APPRENTICE RATE SCHEDULE FOR THOSE APPRENTICES ENTERING PROGRAM AS OF 5-1-14:

INTERVAL	PERIOD AND RATES							
6 Months	50%	55%	60%	65%	70%	75%	80%	90%
Benefits	8.10	8.10	10.34	10.34	11.51	11.51	14.62	14.62

Hazard/Height Pay: +\$1.00 per hour

FOREMAN REQUIREMENTS:

- When there are 4 or more Glaziers on a job, 1 must be designated a Foreman.
- When there are 15 or more Glaziers on a job, 1 must be designated a General Foreman.

The regular workday shall consist of 8 hours, between 7:00 AM and 5:30 PM, Monday to Friday.

SHIFT DIFFERENTIALS:

- The second shift shall receive an additional 10% of the hourly rate, per hour, and the third shift shall receive an additional 15% of the hourly rate, per hour.
- When 3 shifts are worked, the second shift shall receive 8 hours pay for 7.5 hours of work, and the third shift shall receive 8 hours pay for 7 hours of work.

OVERTIME:

Hours in excess of 8 per day, or before or after the regular workday Monday through Friday, and all hours on Saturdays shall be paid at time and one-half the regular rate. All hours on Sundays and holidays shall be paid at double the regular

**NEW JERSEY DEPARTMENT OF LABOR AND WORKFORCE DEVELOPMENT
PREVAILING WAGE RATE DETERMINATION**

County - UNION

rate.

RECOGNIZED HOLIDAYS: New Year's Day, Memorial Day, July 4th, Labor Day, General Election Day, Veterans' Day, Thanksgiving Day, Christmas Day. Saturday holiday observed the preceding Friday. Sunday holiday observed the following Monday.

**NEW JERSEY DEPARTMENT OF LABOR AND WORKFORCE DEVELOPMENT
PREVAILING WAGE RATE DETERMINATION**

County - UNION

Craft: Heat & Frost Insulator

PREVAILING WAGE RATE

	09/19/14
Foreman	W51.52 B28.42 T79.94
General Foreman	W54.07 B29.53 T83.60
Journeyman	W50.24 B27.86 T78.10

Expiration Date: 09/18/2015

Craft: Heat & Frost Insulator

APPRENTICE RATE SCHEDULE

INTERVAL	PERIOD AND RATES									
Yearly	23.27	27.59	33.35	39.16						
Benefits	16.96	20.03	21.99	23.76						

Ratio of Apprentices to Journeymen - 1:3

Craft: Heat & Frost Insulator

COMMENTS/NOTES

NOTE: These rates apply to the installing of insulation on hot and cold mechanical systems.

The regular workday shall be 8 hours between 8:00 AM and 4:30 PM.

SHIFT DIFFERENTIAL:

- Shift work must run for a minimum of 5 consecutive workdays.
- Second Shift shall work 7.5 hours and receive 8 hours pay, at the regular rate, plus 25% per hour.
- Third Shift shall work 7 hours and receive 8 hours pay, at the regular rate, plus 30% per hour.

OVERTIME:

The first 2 hours in excess of 8 per day, hours outside of the regular workday Monday through Friday that are not shift work, and the first 10 hours on Saturday, shall be paid at time and one-half the regular rate, inclusive of benefits. All hours in excess of 10 per day, and all hours on Sunday and holidays (except Labor Day) shall be paid at double the regular rate, inclusive of benefits. All hours on Labor Day shall be paid at triple the regular rate, inclusive of benefits.

RECOGNIZED HOLIDAYS: New Year's Day, President's Day, Memorial Day, July 4th, Labor Day, Veterans' Day, Presidential Election Day, Thanksgiving Day and Christmas Day. Sunday holidays observed the following Monday.

**NEW JERSEY DEPARTMENT OF LABOR AND WORKFORCE DEVELOPMENT
PREVAILING WAGE RATE DETERMINATION**

County - UNION

Craft: Heat & Frost Insulator - Asbestos Worker

PREVAILING WAGE RATE

	09/19/14
Asbestos Worker/Firestop	W25.68 B9.25 T34.93
Foreman	W51.52 B28.42 T79.94

Expiration Date: 09/18/2015

Craft: Heat & Frost Insulator - Asbestos Worker

APPRENTICE RATE SCHEDULE

INTERVAL	PERIOD AND RATES									
	SEE	HEAT &	FROST	INSULAT OR						

Ratio of Apprentices to Journeymen - 1:3

Craft: Heat & Frost Insulator - Asbestos Worker

COMMENTS/NOTES

NOTE: These rates apply only to the removal of insulation materials/asbestos from mechanical systems, including containment erection and demolition, and placing material in appropriate containers.

The regular workday shall be 8 hours between 8:00 AM and 4:30 PM.

SHIFT DIFFERENTIALS:

- Shift work must run for a minimum of 5 consecutive workdays.
- The second shift shall work 7.5 hours and receive 8 hours pay at the regular rate, plus 25% per hour.
- The third shift shall work 7 hours and receive 8 hours pay at the regular rate, plus 30% per hour.

OVERTIME: The first 2 hours in excess of 8 per day, hours outside of the regular workday Monday through Friday that are not shift work, and the first 10 hours on Saturday, shall be paid at time and one-half the regular rate, inclusive of benefits. All hours in excess of 10 per day, and all hours on Sunday and holidays (except Labor Day) shall be paid at double the regular rate, inclusive of benefits. All hours on Labor Day shall be paid at triple the regular rate, inclusive of benefits.

RECOGNIZED HOLIDAYS: New Year's Day, Presidents' Day, Memorial Day, July 4th, Labor Day, Veterans' Day, Presidential Election Day, Thanksgiving Day and Christmas Day. Sunday holidays observed the following Monday.

**NEW JERSEY DEPARTMENT OF LABOR AND WORKFORCE DEVELOPMENT
PREVAILING WAGE RATE DETERMINATION**

County - UNION

Craft: Ironworker

PREVAILING WAGE RATE

	08/13/15	01/01/16	07/01/16	07/01/17
Rod /Fence Foreman	W41.24 B42.27 T83.51	W0.00 B0.00 T84.51	W0.00 B0.00 T86.51	W0.00 B0.00 T88.51
Rod/Fence Journeyman	W38.24 B42.27 T80.51	W0.00 B0.00 T81.51	W0.00 B0.00 T83.51	W0.00 B0.00 T85.51
Structural Foreman	W44.29 B42.77 T87.06	W44.29 B42.77 T87.06	W0.00 B0.00 T88.81	W0.00 B0.00 T90.56
Structural Journeyman	W41.29 B42.77 T84.06	W41.29 B42.77 T84.06	W0.00 B0.00 T85.81	W0.00 B0.00 T87.56

Expiration Date: 06/30/2018

Craft: Ironworker

APPRENTICE RATE SCHEDULE

<u>INTERVAL</u>	<u>PERIOD AND RATES</u>									
6 Months	50%	60%		Yearly	70%	80%	90%			

Ratio of Apprentices to Journeymen - 1:4

Craft: Ironworker

COMMENTS/NOTES

HAZARDOUS WASTE WORK: On hazardous waste removal work on a state or federally designated hazardous waste site where the Ironworker is required to wear Level A,B, or C personal protection: + \$3.00 per hour

The regular workday consists of 8 hours between 6:00 AM and 4:30 PM.

FOREMAN REQUIREMENTS:

When there are 2 or more Ironworkers on a job, 1 shall be designated a Foreman.

SHIFT DIFFERENTIALS:

- When a 2 shift schedule is established, the first, or day shift , shall be established on an 8 hour basis .The second shift shall be established on an 8 hour basis, and receive the regular rate plus 15%.
- When a three shift schedule is established, the first shift shall be established on an 8 hour basis, the second shift on a 7.5 hour basis, and the third shift on a 7 hour basis. The first shift shall receive the regular hourly rate, the second shift shall receive the regular rate plus 15%, and the third shift shall receive the regular rate plus 20%.
- When there is no day shift, and a second or third shift is established, it shall be established on an 8 hour basis.
- When an irregular shift is established for 5 consecutive days, the rate shall be paid at the regular rate and benefit rate , with no wage premium included. When an irregular shift is established for less than 5 days, the rate shall be paid at the regular rate plus 15%.

OVERTIME:

**NEW JERSEY DEPARTMENT OF LABOR AND WORKFORCE DEVELOPMENT
PREVAILING WAGE RATE DETERMINATION**

County - UNION

- All hours in excess of 8 per day, or before or after an established shift that are not shift work, and all hours on Saturday, shall be paid at time and one-half the regular rate, inclusive of benefits. All hours on Sunday and holidays shall be paid at double the hourly rate, inclusive of benefits. Saturday may be used as a make-up day for a day lost to inclement weather. If Saturday is not a make-up day, all hours on Saturday shall be paid at time and one-half the hourly rate, inclusive of benefits.

- Four 10-hour days may be worked, Monday to Thursday, at straight time. Friday may be used as a make-up day for a day lost to inclement weather. If Friday is not a make-up day, all hours on Friday shall be paid at time and one-half the hourly rate, inclusive of benefits.

RECOGNIZED HOLIDAYS: New Year's Day, Presidents' Day, Memorial Day, July 4th, Labor Day, Presidential Election Day, Veterans Day, Thanksgiving Day, Christmas Day.

**NEW JERSEY DEPARTMENT OF LABOR AND WORKFORCE DEVELOPMENT
PREVAILING WAGE RATE DETERMINATION**

County - UNION

Craft: Laborer - Asbestos & Hazardous Waste Removal

PREVAILING WAGE RATE

	12/17/14
Foreman	W38.00 B16.20 T54.20
Journeyman (Handler)	W36.00 B16.20 T52.20

Expiration Date: 11/30/2015

Craft: Laborer - Asbestos & Hazardous Waste Removal

APPRENTICE RATE SCHEDULE

INTERVAL	PERIOD AND RATES									
Yearly	27.96	28.66	29.72	31.84						
Benefits	16.15	for	all	intervals						

Ratio of Apprentices to Journeymen - *

* Ratio of apprentices to journeymen shall not be more than one apprentice for the first journeyman and no more than (1) apprentice for each additional three (3) journeymen.

Craft: Laborer - Asbestos & Hazardous Waste Removal

COMMENTS/NOTES

NOTE: These rates apply to work in connection with Asbestos, Radiation, Hazardous Waste, Lead, Chemical, Biological, Mold Remediation and Abatement.

The regular workday shall be 8 hours between 6:00 AM and 6:00 PM.

OVERTIME:

- Hours in excess of 8 per day, Monday through Saturday, and all hours on Sunday and holidays shall be paid at time and one-half the regular rate.
- When the owner (Public Body) mandates that work is to be performed on Sunday, those hours may be worked at straight time, up to 8 hours per day, up to 40 hours per week.
- Benefits on ALL overtime hours shall be paid at straight time.

RECOGNIZED HOLIDAYS: New Year's Day, President's Day, Good Friday, Easter, Memorial Day, July 4th, Labor Day, Presidential Election Day, Veterans' Day, Thanksgiving Day, Christmas Day.

**NEW JERSEY DEPARTMENT OF LABOR AND WORKFORCE DEVELOPMENT
PREVAILING WAGE RATE DETERMINATION**

County - UNION

Craft: Laborer - Building

PREVAILING WAGE RATE

	05/04/15
Class A Journeyman	W30.65 B25.22 T55.87
Class B Journeyman	W30.15 B25.22 T55.37
Class C Journeyman	W25.63 B25.22 T50.85
Foreman	W34.48 B25.22 T59.70
General Foreman	W38.31 B25.22 T63.53

Expiration Date: 04/30/2016

Craft: Laborer - Building

APPRENTICE RATE SCHEDULE

INTERVAL	PERIOD AND RATES									
	60%	70%	80%	90%						
6 Months										
Benefit	21.97	21.97	21.97	21.97						

Ratio of Apprentices to Journeymen - *

* Ratio of apprentices to journeymen shall not be more than one apprentice for the first journeyman and no more than (1) apprentice for each additional three (3) journeymen.

Craft: Laborer - Building

COMMENTS/NOTES

CLASS A: Specialist laborer including mason tender or concrete pour crew; scaffold builder (scaffolds up to 14 feet in height); operator of forklifts, Bobcats (or equivalent machinery), jack hammers, tampers, motorized tampers and compactors, vibrators, street cleaning machines, hydro demolition equipment, riding motor buggies, conveyors, burners; and nozzlemen on gunite work.

CLASS B: Basic laborer - includes all laborer work not listed in Class A or Class C.

CLASS C: Janitorial-type light clean-up work associated with the TURNOVER of a project, or part of a project, to the owner. All other clean-up work is Class B.

The regular workday shall be 8 hours between 6:00 AM and 6:00 PM.

SHIFT DIFFERENTIALS:

- Shift work must run for a minimum of 5 consecutive workdays.

- When a 2-shift schedule is worked, including a day shift, both shifts shall be established on the basis of 8 hours pay for 8 hours worked. The second shift shall receive the regular rate plus an additional 10%.

**NEW JERSEY DEPARTMENT OF LABOR AND WORKFORCE DEVELOPMENT
PREVAILING WAGE RATE DETERMINATION**

County - UNION

- When a 3-shift schedule is worked, the day shift shall be established on the basis of 8 hours pay for 8 hours worked, the second shift shall be established on the basis of 8 hours pay for 7.5 hours worked, and the third shift shall be established on the basis of 8 hours pay for 7 hours worked. The day shift shall receive the regular rate, the second shift shall receive the regular rate plus an additional 10%, and the third shift shall receive the regular rate plus an additional 15%.
- When a second or third shift is worked with no day shift, the second or third shift shall be established on the basis of 8 hours pay for 8 hours worked. The second shift shall receive the regular rate plus an additional 10%, and the third shift shall receive the regular rate plus an additional 15%.

OVERTIME:

- Hours in excess of 8 per day, or outside the regular workday that are not shift work, Monday through Friday, and all hours on Saturdays shall be paid at time and one-half the regular rate. Saturday may be used as a make-up day (paid at straight time) for a day lost to inclement weather, or for a holiday that is observed during the work week, Monday through Friday. All hours on Sundays and holidays shall be paid at double the regular rate.
- Four 10-hour days may be worked Monday to Thursday, at straight time, with Friday used a make-up day for a day lost to inclement weather. If Friday is not a make-up day, all hours on Friday shall be paid at time and one-half the regular rate.
- Benefits on ALL overtime hours shall be paid at time and one-half.

RECOGNIZED HOLIDAYS: New Year's Day, Washington's Birthday, Memorial Day, July 4th, Labor Day, Presidential Election Day, Veterans' Day, Thanksgiving Day, Christmas Day. Sunday holidays observed the following Monday.

**NEW JERSEY DEPARTMENT OF LABOR AND WORKFORCE DEVELOPMENT
PREVAILING WAGE RATE DETERMINATION**

County - UNION

Craft: Laborer - Heavy & General

PREVAILING WAGE RATE

Rates are located in the
"Statewide" rate package

Expiration Date:

Craft: Laborer - Heavy & General

APPRENTICE RATE SCHEDULE

INTERVAL	PERIOD AND RATES									
1000 Hours	60%	70%	80%	90%						
Benefit	18.03	for	all	intervals						

Ratio of Apprentices to Journeymen - *

* No more than 1 apprentice for the first journeyman and no more than 1 apprentice for each additional 3 journeymen.

Craft: Laborer - Heavy & General

COMMENTS/NOTES

Heavy & General Laborer rates are located in the "Statewide" rate package.

With respect to the APPRENTICE RATE SCHEDULE, the following shall apply:

- On 9-1-15- benefits shall be \$18.03.
- On 3-1-16- benefits shall be \$18.78.
- On 9-1-16- benefits shall be \$18.78.
- On 3-1-17- benefits shall be \$19.53.

**NEW JERSEY DEPARTMENT OF LABOR AND WORKFORCE DEVELOPMENT
PREVAILING WAGE RATE DETERMINATION**

County - UNION

Craft: Millwright

PREVAILING WAGE RATE

	05/01/15
Foreman	W51.72 B29.52 T81.24
Journeyman	W44.97 B25.74 T70.71

Expiration Date: 10/31/2015

Craft: Millwright

APPRENTICE RATE SCHEDULE

INTERVAL	PERIOD AND RATES									
	40%	45%	50%	55%	60%	65%	70%	75%	85%	95%
6 Months										
Benefits	56% of	Appren	tice	Wage	Rate	for all	intervals	+ \$.55		

Ratio of Apprentices to Journeymen - 1:4

Craft: Millwright

COMMENTS/NOTES

FOREMAN REQUIREMENTS:

- When there are 2 or more Millwrights on a job, 1 shall be designated as a Foreman.
- When there are 21 or more Millwrights on a job, 2 shall be designated as Foremen.

The regular workday shall consist of 8 hours, starting between 7:00 AM and 9:00 AM.

SHIFT DIFFERENTIALS:

- When a 2 shift schedule (including a day shift) is established, the day shift shall be established on an 8 hour basis. The second shift shall be established on an 8 hour basis, and receive the regular rate plus 15%, inclusive of benefits.
- When a three shift schedule is established, the first shift shall be established on an 8 hour basis, the second shift on a 7.5 hour basis, and the third shift on a 7 hour basis. The first shift shall receive the regular hourly rate, the second shift shall receive the regular rate plus 15% and the third shift shall receive the regular rate plus 20%, inclusive of benefits.
- When there is no day shift, and a second or third shift is established, it shall be established on an 8 hour basis. The second shift shall receive the regular rate plus 15% and the third shift shall receive the regular rate plus 20%, inclusive of benefits.

OVERTIME:

- All hours in excess of 8 per day, or before or after an established shift that are not shift work, and all hours on Saturdays shall be paid at time and one-half the hourly rate, inclusive of benefits. All hours on Sundays and holidays shall be paid at double the hourly rate, inclusive of benefits.
- Four 10-hour days may be worked, Monday to Thursday, at straight time. Friday may be used as a make-up day for a day lost due to inclement weather. If Friday is not a make-up day, all hours on Friday shall be paid at time and one-half the hourly rate, inclusive of benefits.

RECOGNIZED HOLIDAYS: New Year's Day, Presidents' Day, Memorial Day, July 4th, Labor Day, Presidential Election

**NEW JERSEY DEPARTMENT OF LABOR AND WORKFORCE DEVELOPMENT
PREVAILING WAGE RATE DETERMINATION**

County - UNION

Day, Veterans' Day, Thanksgiving Day, Christmas Day. Sunday holidays will be observed the following Monday.

**NEW JERSEY DEPARTMENT OF LABOR AND WORKFORCE DEVELOPMENT
PREVAILING WAGE RATE DETERMINATION**

County - UNION

Craft: Operating Engineer

PREVAILING WAGE RATE

Rates are located in the
"Statewide" rate package

Expiration Date:

Craft: Operating Engineer

APPRENTICE RATE SCHEDULE

INTERVAL	PERIOD AND RATES									
Yearly	60%	70%	80%	90%						

Ratio of Apprentices to Journeymen - *

* 1 apprentice for each piece of heavy equipment. At least 10 pieces of heavy equipment or a minimum of 5 Operating Engineers must be on site.

Craft: Operating Engineer

COMMENTS/NOTES

Operating Engineer rates are located in the "Statewide" rate package.

**NEW JERSEY DEPARTMENT OF LABOR AND WORKFORCE DEVELOPMENT
PREVAILING WAGE RATE DETERMINATION**

County - UNION

Craft: Operating Engineer - Field Engineer

PREVAILING WAGE RATE

Rates are located in the
"Statewide" rate package

Expiration Date:

Craft: Operating Engineer - Field Engineer

APPRENTICE RATE SCHEDULE

INTERVAL	PERIOD AND RATES									
Yearly	70%	75%	of Rod/	Chainman	Wage					
Yearly			80%	90%	Transit/	Instrument	man	Wage		

Ratio of Apprentices to Journeymen - *

* No more than 1 Field Engineer Apprentice per Survey Crew.

Craft: Operating Engineer - Field Engineer

COMMENTS/NOTES

Operating Engineer - Field Engineer rates are located in the "Statewide" rate package.

**NEW JERSEY DEPARTMENT OF LABOR AND WORKFORCE DEVELOPMENT
PREVAILING WAGE RATE DETERMINATION**

County - UNION

Craft: Painter - Bridges

PREVAILING WAGE RATE

	05/22/15	05/01/16	05/01/17
Foreman	W56.38 B25.67 T82.05	W58.63 B25.67 T84.30	W61.13 B25.67 T86.80
General Foreman	W58.38 B25.67 T84.05	W60.63 B25.67 T86.30	W63.13 B25.67 T88.80
Journeyman	W51.38 B25.67 T77.05	W53.63 B25.67 T79.30	W56.13 B25.67 T81.80

Expiration Date: 01/31/2019

Craft: Painter - Bridges

APPRENTICE RATE SCHEDULE

INTERVAL	PERIOD AND RATES									
	40%	50%			60%	70%		80%	90%	
6 Months										
Benefits	Intervals	1 to 2 =	8.88	Intervals	3 to 4 =	10.81	Intervals	5 to 6 =	13.48	

Ratio of Apprentices to Journeymen - 1:4

Craft: Painter - Bridges

COMMENTS/NOTES

These rates apply to: All bridges that span waterways, roadways, railways and canyons. All tunnels, overpasses, viaducts and all appurtenances.

FOREMEN REQUIREMENTS:

- When there are 4 or more Painters on a job, 1 shall be designated a Foreman.
- When there are 15 or more Painters on a job, 1 shall be designated a General Foreman.

The regular workday shall consist of 8 hours between 7:00 AM and 5:30 PM.

SHIFT DIFFERENTIALS:

- The second shift shall receive an additional 10% of the hourly rate, per hour, and the third shift shall receive an additional 15% of the hourly rate, per hour.

OVERTIME:

- Hours in excess of 8 per day, Monday through Friday, and all hours on Saturdays and Sundays shall be paid at time and one-half the regular rate. All hours on holidays shall be paid at double the regular rate.
- Saturday or Sunday may be used to make up a day lost to inclement weather, at straight time.
- Four 10-hour days may be worked, at straight time, Monday through Friday.

RECOGNIZED HOLIDAYS: New Year's Day, President's Day, Memorial Day, July 4th, Labor Day, Presidential Election Day, Veterans' Day, Thanksgiving Day, Christmas Day. Saturday holiday observed the preceding Friday. Sunday holiday observed the following Monday.

**NEW JERSEY DEPARTMENT OF LABOR AND WORKFORCE DEVELOPMENT
PREVAILING WAGE RATE DETERMINATION**

County - UNION

Craft: Painter - Line Striping

PREVAILING WAGE RATE

	07/09/15
Foreman (Charge Person)	W34.80 B15.28 T50.08
Helper (1st Year)	W27.33 B14.97 T42.30
Helper (2nd Year)	W28.38 B15.05 T43.43
Helper (3rd Year)	W30.53 B15.11 T45.64
Journeyman	W34.30 B15.28 T49.58

Expiration Date: 11/30/2015

Craft: Painter - Line Striping

COMMENTS/NOTES

OVERTIME:

Hours in excess of 8 per day, Monday through Saturday, and all hours on Sundays and holidays shall be paid at time and one-half the hourly rate.

RECOGNIZED HOLIDAYS: New Year's Day, Presidents' Day, Memorial Day, July 4th, Labor Day, Veterans Day, Thanksgiving Day and Christmas Day. Veterans Day may be substituted for the day after Thanksgiving.

**NEW JERSEY DEPARTMENT OF LABOR AND WORKFORCE DEVELOPMENT
PREVAILING WAGE RATE DETERMINATION**

County - UNION

Craft: Painter - New Construction

PREVAILING WAGE RATE

	06/30/15	05/01/16	05/01/17
Foreman	W41.54 B22.35 T63.89	W42.91 B22.35 T65.26	W44.39 B22.35 T66.74
General Foreman	W45.31 B22.81 T68.12	W46.81 B22.81 T69.62	W48.43 B22.81 T71.24
Journeyman	W37.76 B21.90 T59.66	W39.01 B21.90 T60.91	W40.36 B21.90 T62.26

Expiration Date: 04/30/2018

Craft: Painter - New Construction

APPRENTICE RATE SCHEDULE

INTERVAL	PERIOD AND RATES									
	30%	40%	50%	60%	70%	75%	80%	85%	90%	
4 Months										
Benefits	Intervals	1 to 3 =	8.00	Intervals	4 to 6 =	10.00	Intervals	7 to 9 =	11.00	

Ratio of Apprentices to Journeymen - 1:4

Craft: Painter - New Construction

COMMENTS/NOTES

APPRENTICE RATE SCHEDULE FOR THOSE APPRENTICES ENTERING PROGRAM ON 5-1-14:

INTERVAL	PERIOD AND RATES							
6 Months	40%	45%	55%	65%	70%	75%	80%	90%
Benefits	8.00	8.00	10.00	10.00	11.00	11.00	14.00	14.00

Spraying, sandblasting, lead abatement, work on tanks or stacks, work performed above 3 stories or 30 feet in height, or using swing scaffolds requires an additional 10% of the wage rate.

FOREMEN REQUIREMENTS:

- When there are 4 or more Painters on a job, 1 shall be designated a Foreman.
- When there are 15 or more Painters on a job, 1 shall be designated a General Foreman.

The regular workday shall consist of 8 hours between 7:00 AM and 5:30 PM.

SHIFT DIFFERENTIALS:

- The second shift shall receive an additional 10% of the hourly rate, per hour, and the third shift shall receive an additional 15% of the hourly rate, per hour.

OVERTIME:

- Hours in excess of 8 per day, or before or after the regular workday, Monday through Friday, and all hours on Saturdays shall be paid at time and one-half the regular rate. All hours on Sundays and holidays shall be paid at double the regular

**NEW JERSEY DEPARTMENT OF LABOR AND WORKFORCE DEVELOPMENT
PREVAILING WAGE RATE DETERMINATION**

County - UNION

rate.

- Saturday or Sunday may be used to make up a day lost to inclement weather, at straight time.
- Four 10-hour days may be worked, at straight time, Monday through Friday.

RECOGNIZED HOLIDAYS: New Year's Day, President's Day, Memorial Day, July 4th, Labor Day, General Election Day, Veterans' Day, Thanksgiving Day, Christmas Day.

**NEW JERSEY DEPARTMENT OF LABOR AND WORKFORCE DEVELOPMENT
PREVAILING WAGE RATE DETERMINATION**

County - UNION

Craft: Painter - Repainting

PREVAILING WAGE RATE

	06/30/15	05/01/16	05/01/17
Foreman	W31.41 B18.45 T49.86	W32.79 B18.45 T51.24	W34.17 B18.45 T52.62
General Foreman	W34.27 B18.45 T52.72	W35.77 B18.45 T54.22	W37.39 B18.45 T55.84
Journeyman	W28.56 B18.45 T47.01	W29.81 B18.45 T48.26	W31.16 B18.45 T49.61

Expiration Date: 04/30/2018

Craft: Painter - Repainting

APPRENTICE RATE SCHEDULE

INTERVAL	PERIOD AND RATES									
	SEE	PAINTER	NEW	CONSTR	TION					
				UC						

Ratio of Apprentices to Journeymen - 1:4

Craft: Painter - Repainting

COMMENTS/NOTES

NOTE: These rates may only be used on jobs where no major alterations occur, and where not more than 3 other trades are present on the job, but may NOT, under any circumstances, be used for work on bridges, stacks, elevated tank, or generating stations.

Spraying, sandblasting, lead abatement, work on tanks or stacks, work performed above 3 stories or 30 feet in height, or using swing scaffolds requires an additional 10% of the wage rate.

FOREMEN REQUIREMENTS:

- When there are 4 or more Painters on a job, 1 shall be designated a Foreman.
- When there are 15 or more Painters on a job, 1 shall be designated a General Foreman.

OVERTIME:

- Hours in excess of 8 per day and 40 per week shall be paid at time and one-half the regular rate.
- Four 10-hour days may be worked, at straight time, Monday through Sunday.

RECOGNIZED HOLIDAYS: New Year's Day, President's Day, Memorial Day, July 4th, Labor Day, General Election Day, Veterans' Day, Thanksgiving Day, Christmas Day.

**NEW JERSEY DEPARTMENT OF LABOR AND WORKFORCE DEVELOPMENT
PREVAILING WAGE RATE DETERMINATION**

County - UNION

Craft: Painter- Containment

PREVAILING WAGE RATE

	05/22/15	05/01/16	05/01/17
Journeyman	W32.93 B22.92 T55.85	W35.18 B22.92 T58.10	W37.68 B22.92 T60.60

Expiration Date: 01/31/2019

Craft: Painter- Containment

COMMENTS/NOTES

NOTE: These rates shall require no painting, but used in a supporting capacity only, such as wrapping, boxing, fencing, etc. on tanks.

The regular workday shall consist of 8 hours between 7:00 AM and 5:30 PM.

SHIFT DIFFERENTIALS:

- The second shift shall receive an additional 10% of the hourly rate, per hour, and the third shift shall receive an additional 15% of the hourly rate, per hour.

OVERTIME:

- Hours in excess of 8 per day, Monday through Friday, and all hours on Saturdays and Sundays shall be paid at time and one-half the regular rate. All hours on holidays shall be paid at double the regular rate..

RECOGNIZED HOLIDAYS: New Year's Day President's Day, Memorial Day, July 4th, Labor Day, Presidential Election Day, Veterans' Day, Thanksgiving Day, Christmas Day. Saturday holiday observed the preceding Friday. Sunday holiday observed the following Monday.

**NEW JERSEY DEPARTMENT OF LABOR AND WORKFORCE DEVELOPMENT
PREVAILING WAGE RATE DETERMINATION**

County - UNION

Craft: Painter-Elevated Water Tanks

PREVAILING WAGE RATE

	05/22/15	05/01/16	05/01/17
Foreman	W46.17 B22.92 T69.09	W48.42 B22.92 T71.34	W50.92 B22.92 T73.84
General Foreman	W48.17 B22.92 T71.09	W50.42 B22.92 T73.34	W52.92 B22.92 T75.84
Journeyman	W41.17 B22.92 T64.09	W43.42 B22.92 T66.34	W45.92 B22.92 T68.84

Expiration Date: 01/31/2019

Craft: Painter-Elevated Water Tanks

APPRENTICE RATE SCHEDULE

INTERVAL	PERIOD AND RATES									
	SEE	PAINTER	BRIDGES							

Craft: Painter-Elevated Water Tanks

COMMENTS/NOTES

These rates apply to: All new and repaint elevated water tanks (interior and exterior).

FOREMEN REQUIREMENTS:

- When there are 4 or more Painters on a job, 1 shall be designated a Foreman.
- When there are 15 or more Painters on a job, 1 shall be designated a General Foreman.

The regular workday shall consist of 8 hours between 7:00 AM and 5:30 PM.

SHIFT DIFFERENTIALS:

- The second shift shall receive an additional 10% of the hourly rate, per hour, and the third shift shall receive an additional 15% of the hourly rate, per hour.

OVERTIME:

- Hours in excess of 8 per day, Monday through Friday, and all hours on Saturdays and Sundays shall be paid at time and one-half the regular rate. All hours on holidays shall be paid at double the regular rate.
- Saturday or Sunday may be used to make up a day lost to inclement weather, at straight time.
- Four 10-hour days may be worked, at straight time, Monday through Friday.

RECOGNIZED HOLIDAYS: New Year's Day, President's Day, Memorial Day, July 4th, Labor Day, Presidential Election Day, Veterans' Day, Thanksgiving Day, Christmas Day. Saturday holiday observed the preceding Friday. Sunday holiday observed the following Monday.

**NEW JERSEY DEPARTMENT OF LABOR AND WORKFORCE DEVELOPMENT
PREVAILING WAGE RATE DETERMINATION**

County - UNION

Craft: Painter-Structural Steel

PREVAILING WAGE RATE

	05/22/15	05/01/16	05/01/17
Foreman	W45.12 B23.26 T68.38	W47.37 B23.26 T70.63	W49.87 B23.26 T73.13
General Foreman	W47.12 B23.26 T70.38	W49.37 B23.26 T72.63	W51.87 B23.26 T75.13
Journeyman	W40.12 B23.26 T63.38	W42.37 B23.26 T65.63	W44.87 B23.26 T68.13

Expiration Date: 01/31/2019

Craft: Painter-Structural Steel

APPRENTICE RATE SCHEDULE

INTERVAL	PERIOD AND RATES									
	SEE	PAINTER	BRIDGES							

Craft: Painter-Structural Steel

COMMENTS/NOTES

These rates apply to: All work in power plants (any aspect). On steeples, on dams, on hangers, transformers, substations, etc. and on open steel, whether new or repaint. All new work (excluding traditional commercial painting work) in refineries, tank farms, water/sewerage treatment facilities and on pipelines.

FOREMEN REQUIREMENTS:

- When there are 4 or more Painters on a job, 1 shall be designated a Foreman.
- When there are 15 or more Painters on a job, 1 shall be designated a General Foreman.

The regular workday shall consist of 8 hours between 7:00 AM and 5:30 PM.

SHIFT DIFFERENTIALS:

- The second shift shall receive an additional 10% of the hourly rate, per hour, and the third shift shall receive an additional 15% of the hourly rate, per hour.

OVERTIME:

- Hours in excess of 8 per day, Monday through Friday, and all hours on Saturdays and Sundays shall be paid at time and one-half the regular rate. All hours on holidays shall be paid at double the regular rate.
- Saturday or Sunday may be used to make up a day lost to inclement weather, at straight time.
- Four 10-hour days may be worked, at straight time, Monday through Friday.

RECOGNIZED HOLIDAYS: New Year's Day, President's Day, Memorial Day, July 4th, Labor Day, Presidential Election Day, Veterans' Day, Thanksgiving Day, Christmas Day. Saturday holiday observed the preceding Friday. Sunday holiday observed the following Monday.

**NEW JERSEY DEPARTMENT OF LABOR AND WORKFORCE DEVELOPMENT
PREVAILING WAGE RATE DETERMINATION**

County - UNION

Craft: Paperhanger - New Construction

PREVAILING WAGE RATE

	06/30/15	05/01/16	05/01/17
Foreman	W42.51 B21.44 T63.95	W43.83 B21.44 T65.27	W45.32 B21.44 T66.76
Journeyman	W38.65 B22.01 T60.66	W39.85 B22.01 T61.86	W41.20 B22.01 T63.21

Expiration Date: 04/30/2018

Craft: Paperhanger - New Construction

APPRENTICE RATE SCHEDULE

INTERVAL	PERIOD AND RATES									
	30%	40%	50%	60%	70%	75%	80%	85%	90%	
4 Months										
Benefits	Intervals	1 to 3 =	8.00	Intervals	4 to 6 =	10.00	Intervals	7 to 9 =	11.00	

Ratio of Apprentices to Journeymen - 1:4

Craft: Paperhanger - New Construction

COMMENTS/NOTES

APPRENTICE RATE SCHEDULE FOR THOSE APPRENTICES ENTERING PROGRAM ON 5-1-14:

INTERVAL	PERIOD AND RATES							
6 Months	40%	45%	55%	65%	70%	75%	80%	90%
Benefits	8.00	8.00	10.00	10.00	11.00	11.00	14.00	14.00

FOREMEN REQUIREMENTS:

- When there are 4 or more Paperhangers on a job, 1 shall be designated a Foreman.

The regular workday shall consist of 8 hours between 7:00 AM and 5:30 PM.

SHIFT DIFFERENTIALS:

- The second shift shall receive an additional 10% of the hourly rate, per hour, and the third shift shall receive an additional 15% of the hourly rate, per hour.

OVERTIME:

- Hours in excess of 8 per day, Monday through Friday, and all hours on Saturdays shall be paid at time and one-half the regular rate. All hours on Sundays and holidays shall be paid at double the regular rate.
- Saturday or Sunday may be used to make up a day lost to inclement weather, at straight time.
- Four 10-hour days may be worked, at straight time, Monday through Friday.

RECOGNIZED HOLIDAYS: New Year's Day, President's Day, Memorial Day, July 4th, Labor Day, General Election Day, Veterans' Day, Thanksgiving Day, Christmas Day.

**NEW JERSEY DEPARTMENT OF LABOR AND WORKFORCE DEVELOPMENT
PREVAILING WAGE RATE DETERMINATION**

County - UNION

Craft: Paperhanger - Renovation

PREVAILING WAGE RATE

	06/30/15	05/01/16	05/01/17
Foreman	W32.21 B18.53 T50.74	W33.58 B18.53 T52.11	W35.06 B18.53 T53.59
Journeyman	W29.28 B18.53 T47.81	W30.53 B18.53 T49.06	W31.88 B18.53 T50.41

Expiration Date: 04/30/2018

Craft: Paperhanger - Renovation

APPRENTICE RATE SCHEDULE

INTERVAL	PERIOD AND RATES									
	SEE	PAPER-	HANGER	NEW	CONSTR	TION				
					UC					

Ratio of Apprentices to Journeymen - 1:4

Craft: Paperhanger - Renovation

COMMENTS/NOTES

NOTE: These rates may only be used on jobs where no major alterations occur, and where not more than 3 other trades are present on the job, but may NOT, under any circumstances, be used for work on bridges, stacks, elevated tanks, or generating stations.

FOREMEN REQUIREMENTS:

- When there are 4 or more Paperhangers on a job, 1 shall be designated a Foreman.

OVERTIME:

- Hours in excess of 8 per day and 40 per week shall be paid at time and one-half the regular rate.
- Four 10-hour days may be worked, at straight time, Monday through Sunday.

**NEW JERSEY DEPARTMENT OF LABOR AND WORKFORCE DEVELOPMENT
PREVAILING WAGE RATE DETERMINATION**

County - UNION

Craft: Pipefitter

PREVAILING WAGE RATE

	05/01/15
Foreman	W50.42 B38.67 T89.09
Journeyman	W46.67 B35.80 T82.47

Expiration Date: 04/30/2016

Craft: Pipefitter

APPRENTICE RATE SCHEDULE

INTERVAL	PERIOD AND RATES									
	Yearly	35%	45%	55%	65%	75%				
Benefit	76.5% of	Appren	tice	Wage	Rate + .10	cents				

Ratio of Apprentices to Journeymen - 1:5

Craft: Pipefitter

COMMENTS/NOTES

FOREMAN REQUIREMENTS:

- When there are 2 or more Journeyman Pipefitters on a job, 1 shall be designated a Foreman.
- There shall be a Foreman for every 8 Journeyman Pipefitters on a job.

The regular workday shall be 8 hours between 7:00 AM and 3:30 PM.

SHIFT DIFFERENTIAL:

- 2nd Shift (3:30 PM-11:30 PM) shall work 7.5 hours and receive 8 hours pay at the regular rate, plus 25% per hour.
- 3rd Shift (11:30 PM-7:00 AM) shall work 7 hours and receive 8 hours pay at the regular rate, plus 30% per hour.

OVERTIME:

- All hours worked in excess of 8 per day, Monday through Friday, and all hours worked on Saturday, shall be paid at time and one-half, inclusive of benefits. All hours on Sunday and holidays shall be paid at double time, inclusive of benefits.
- By mutual agreement, employees may work four 10-hour days, Monday to Thursday, at straight time rate. Friday may be used as a make-up day for a day lost to inclement weather, and may be paid at straight time. If Friday is not a make-up day, the first 8 hours shall be paid at time and one-half, inclusive of benefits; hours in excess of 8 shall be paid at double time, inclusive of benefits.

SHIFT DIFFERENTIAL (Maintenance Work Only):

- 2nd Shift (3:30 PM-11:30 PM) shall work 7.5 hours and receive 8 hours pay at the regular rate, plus 10% per hour.
- 3rd Shift (11:30 PM-7:00 AM) shall work 7 hours and receive 8 hours pay at the regular rate, plus 15% per hour.

OVERTIME (Maintenance Work Only):

- All hours in excess of 8 per day, Monday through Saturday, shall be paid at time and one-half, inclusive of benefits. All hours on Sundays and holidays shall be paid at double time, inclusive of benefits.

**NEW JERSEY DEPARTMENT OF LABOR AND WORKFORCE DEVELOPMENT
PREVAILING WAGE RATE DETERMINATION**

County - UNION

NOTE: Maintenance work is work to repair, restore, or improve the efficiency of existing facilities. This does NOT apply to ANY new construction.

RECOGNIZED HOLIDAYS: New Year's Day, Presidents' Day, Memorial Day, July 4th, Labor Day, Presidential Election Day, Veterans' Day, Thanksgiving Day, Christmas Day. Sunday holidays are observed the following Monday.

**NEW JERSEY DEPARTMENT OF LABOR AND WORKFORCE DEVELOPMENT
PREVAILING WAGE RATE DETERMINATION**

County - UNION

Craft: Plasterer

PREVAILING WAGE RATE

See Bricklayer, Stone Mason Rates

Expiration Date:

Craft: Plasterer

COMMENTS/NOTES

See BRICKLAYER, STONE MASON Rates

**NEW JERSEY DEPARTMENT OF LABOR AND WORKFORCE DEVELOPMENT
PREVAILING WAGE RATE DETERMINATION**

County - UNION

Craft: Plumber PREVAILING WAGE RATE

	05/01/15
Foreman	W54.39 B31.94 T86.33
General Foreman	W57.91 B31.94 T89.85
Journeyman	W50.36 B31.94 T82.30

Expiration Date: 04/30/2016

Craft: Plumber APPRENTICE RATE SCHEDULE

INTERVAL	PERIOD AND RATES									
Yearly	30%	45%	55%	65%	75%					
Benefits	12.24	18.04	19.65	21.28	22.89					

Ratio of Apprentices to Journeymen - *

* Employers may employ 1 apprentice on any job where 1 or 2 journeymen are employed. Thereafter, 1 apprentice may be employed for every 4 journeymen.

Craft: Plumber COMMENTS/NOTES

FOREMAN REQUIREMENTS:

- On any job having 2 or more Plumbers, 1 must be designated a Foreman.
- On any job having 9 or more Plumbers, 2 shall be designated as Foremen.

The regular workday shall consist of 8 hours between 7:00 AM and 4:30 PM.

SHIFT DIFFERENTIALS:

- Shift work must continue for a minimum of 5 consecutive workdays.
- When two shifts are worked, the second shift shall work 7.5 hours and receive 8 hours pay, at a rate equal to the hourly rate plus 10%, inclusive of benefits.
- When a third shift is worked, the third shift shall work 7 hours and receive 8 hours pay, at a rate equal to the hourly rate plus 15%, inclusive of benefits.

OVERTIME:

- All hours in excess of 8 per day, or before of after the regular workday that are not shift work, Monday through Friday, and all hours on Saturday, shall be paid at time and one-half the regular rate, inclusive of benefits. All hours on Sunday and holidays, shall be paid at double the hourly rate, inclusive of benefits.
- Four 10-hour days may be worked, Monday to Thursday, at straight time. Friday may be used as a make-up day for a day lost due to inclement weather. If Friday is not a make-up day, all hours on Friday shall be paid at time and one-half, inclusive of benefits.

RECOGNIZED HOLIDAYS: New Year's Day, Presidents' Day, Memorial Day, July 4th, Labor Day, Presidential Election

**NEW JERSEY DEPARTMENT OF LABOR AND WORKFORCE DEVELOPMENT
PREVAILING WAGE RATE DETERMINATION**

County - UNION

Day, Veterans' Day, Thanksgiving Day, Christmas Day. Sunday holidays will be observed the following Monday.

**NEW JERSEY DEPARTMENT OF LABOR AND WORKFORCE DEVELOPMENT
PREVAILING WAGE RATE DETERMINATION**

County - UNION

Craft: Roofer PREVAILING WAGE RATE

	06/02/15
Foreman	W36.27 B24.04 T60.31
Journeyman	W35.27 B24.04 T59.31

Expiration Date: 05/31/2016

Craft: Roofer APPRENTICE RATE SCHEDULE

INTERVAL	PERIOD AND RATES									
	40%	50%	60%	70%	80%	90%				
6 Months										
Benefits	1.85	1.85	21.25	21.25	21.25	21.25				

Ratio of Apprentices to Journeymen - *

- * A) For roofing jobs that are of the 1 or single ply nature: 1:2 or fraction thereof
- B) For roofing jobs on new built up roofs: 1:3 or fraction thereof
- C) For roofing jobs that are of a tear-off nature: 1:2 or fraction thereof
- D) For roofing jobs {not requiring complete removal of existing systems, installation done over existing roof}: 1:3 or fraction thereof

Craft: Roofer COMMENTS/NOTES

Pitch: +.50 per hour

Mop Man: +.30 per hour

The regular workday consists of 8 hours between 8:00 AM and 4:30 PM.

OVERTIME:

Hours in excess of 8 per day, or before or after the regular workday, Monday through Friday, and all hours on Saturdays, Sundays, and holidays shall be paid at time and one-half the regular rate.

RECOGNIZED HOLIDAYS: New Year's Day, Good Friday, Memorial Day, July 4th, Labor Day, Presidential Election Day, Veterans' Day, Thanksgiving Day, Christmas Day.

**NEW JERSEY DEPARTMENT OF LABOR AND WORKFORCE DEVELOPMENT
PREVAILING WAGE RATE DETERMINATION**

County - UNION

Craft: Sheet Metal Sign Installation

PREVAILING WAGE RATE

	04/07/15
Foreman	W32.89 B28.07 T60.96
Journeyman	W31.64 B28.07 T59.71

Expiration Date: 09/30/2015

Craft: Sheet Metal Sign Installation

APPRENTICE RATE SCHEDULE

INTERVAL	PERIOD AND RATES									
	35%	40%	45%	50%	55%	60%	65%	70%	75%	80%
1000 hours										
Benefits	10.34	11.53	12.73	13.92	15.51	16.73	17.97	19.20	20.44	21.66

Ratio of Apprentices to Journeymen - 1:3

Craft: Sheet Metal Sign Installation

COMMENTS/NOTES

FOREMAN REQUIREMENT:

When there are 6 or more Sheet Metal Sign Installers on a job, 1 shall be designated a Foreman.

The regular workday consists of 8 hours, between 7:00 AM and 3:30 PM.

OVERTIME:

Hours before or after the regular workday, Monday through Friday, and all hours worked on Saturday shall be paid at time and one-half the hourly rate. All hours on Sunday and holidays shall be paid at double the hourly rate.

Four(4) 10 hour days may be worked, Monday through Friday, at straight time, for projects lasting at least one week in duration. The fifth day may be used as a make-up day at straight time for a day lost due to inclement weather. However, if the fifth day is not a make-up day, all hours worked will be paid at time and one-half the hourly rate.

RECOGNIZED HOLIDAYS: New Year's Day, Presidents' Day, Good Friday, Memorial Day, July 4th, Labor Day, Veterans' Day, Thanksgiving Day and the day after, Christmas Day. Saturday holidays observed the preceding Friday, Sunday holidays observed the following Monday.

**NEW JERSEY DEPARTMENT OF LABOR AND WORKFORCE DEVELOPMENT
PREVAILING WAGE RATE DETERMINATION**

County - UNION

Craft: Sheet Metal Worker

PREVAILING WAGE RATE

	07/23/15
Foreman	W49.22 B37.00 T86.22
General Foreman	W50.22 B37.00 T87.22
Journeyman	W45.72 B37.00 T82.72

Expiration Date: 05/31/2016

Craft: Sheet Metal Worker

APPRENTICE RATE SCHEDULE

INTERVAL	PERIOD AND RATES									
Yearly	35%	45%	55%	65%	of	Journey	man	Wage	Rate	
Benefit	35%	45%	55%	65%	of	Journey	man	Benefit	Rate	

Ratio of Apprentices to Journeymen - 1:4

Craft: Sheet Metal Worker

COMMENTS/NOTES

FOREMAN REQUIREMENTS:

- When there are 2 or more Sheet Metal Workers on a project, 1 must be designated a Foreman.
- When there are 17 or more Sheet Metal Workers on a project, 1 must be designated a General Foreman.
- When there is only 1 Sheet Metal Worker (1 Journeyman) on a project, he/she shall receive \$1.00 more than the regular Journeyman's rate.

The regular workday is 8 hours between 7:00 AM and 4:30 PM.

SHIFT DIFFERENTIAL:

- 2nd Shift (3:30 PM - 12:00 AM) : +17% of regular hourly rate
- Shift work must run for a minimum of 5 consecutive workdays.

OVERTIME:

- Hours in excess of 8 per day, or before or after the regular workday, that are not shift work, and the first 10 hours on Saturdays shall be paid at time and one-half of the regular rate, inclusive of benefits. Hours in excess of 10 per day on Saturday, and all hours on Sundays and holidays shall be at double the regular rate, inclusive of benefits.
- Four 10-hour days may be worked, Monday through Friday, at straight time, with hours in excess of 10 per day, and hours in excess of 40 per week paid at the overtime rates listed above.

RECOGNIZED HOLIDAYS: New Year's Day, Presidents' Day, Good Friday, Memorial Day, July 4th, Labor Day, Presidential Election Day, Veterans' Day, Thanksgiving Day, Christmas Day. Sunday holidays will be observed the following Monday.

**NEW JERSEY DEPARTMENT OF LABOR AND WORKFORCE DEVELOPMENT
PREVAILING WAGE RATE DETERMINATION**

County - UNION

Craft: Sprinkler Fitter

PREVAILING WAGE RATE

	07/01/15
Foreman	W62.13 B24.52 T86.65
General Foreman	W65.10 B24.52 T89.62
Journeyman	W58.13 B24.52 T82.65

Expiration Date: 12/31/2015

Craft: Sprinkler Fitter

APPRENTICE RATE SCHEDULE

INTERVAL	PERIOD AND RATES									
1000 Hours	9.50	11.25	29.07	31.97	34.88	37.78	40.69	43.60	46.50	49.41
Benefits	10.12	10.12	20.27	20.27	20.27	20.27	Intervals	7 to 10	Jourymn	Ben.

APPRENTICE RATE SCHEDULE FOR THOSE APPRENTICES REGISTERED AS OF 7-1-13:

INTERVAL	PERIOD AND RATES									
1000 hours	14.53	17.44	23.25	26.16	31.97	34.88	40.69	43.60	49.41	52.32
Benefits	10.12	10.12	20.27	20.27	20.27	20.27	Intervals	7 to 10	receive	Journeyman Ben.

Craft: Sprinkler Fitter

COMMENTS/NOTES

The regular workday consists of 8 consecutive hours between 6:00 AM and 4:30 PM.

FOREMAN REQUIREMENTS:

- The first Sprinkler Fitter on the job must be designated a Foreman.
- On any job having 12 or more Sprinkler Fitters, one must be designated a General Foreman.

SHIFT DIFFERENTIALS:

- Shift work must run for a minimum of 2 consecutive workdays.
- 2nd and 3rd shift shall receive an additional 15% of the regular rate, per hour.
- Any "off hours" shift starting at 8:00 PM or later shall receive an additional 25% of the regular rate, per hour.

OVERTIME:

The first 2 hours in excess of 8 per day, after the regular workday that are not shift work, Monday through Friday, shall be paid at time and one-half the regular rate. Hours worked in excess of 10 per day, Monday through Friday, and all hours on Saturday, Sunday and holidays, shall be paid double the regular rate.

Four 10 hour days may be worked, Monday through Thursday, at straight-time.

RECOGNIZED HOLIDAYS: New Year's Day, Presidents' Day, Good Friday, Memorial Day, July 4th, Labor Day, Presidential Election Day, Veterans Day, Thanksgiving Day, Christmas Day.

**NEW JERSEY DEPARTMENT OF LABOR AND WORKFORCE DEVELOPMENT
PREVAILING WAGE RATE DETERMINATION**

County - UNION

Craft: Tile Finisher-Marble PREVAILING WAGE RATE

	07/01/15	01/01/16	07/01/16	01/01/17	07/01/17	01/01/18
Finisher	W45.08	W45.35	W45.66	W46.01	W46.32	W46.66
	B30.56	B31.19	B31.95	B32.68	B33.44	B34.18
	T75.64	T76.54	T77.61	T78.69	T79.76	T80.84

Expiration Date: 06/30/2018

Craft: Tile Finisher-Marble APPRENTICE RATE SCHEDULE

INTERVAL	PERIOD AND RATES									
750 Hours	50%	55%	65%	70%	75%	85%	90%	95%		

Ratio of Apprentices to Journeymen - 1:4

Craft: Tile Finisher-Marble COMMENTS/NOTES

OVERTIME:

Hours in excess of 7 per day, Monday through Friday, and the first 7 hours on Saturdays shall be paid at time and one half the regular rate, inclusive of benefits. Hours in excess of 7 on Saturdays and all hours on Sundays and holidays shall be paid at double the regular rate, inclusive of benefits.

RECOGNIZED HOLIDAYS: New Year's Day, Presidents' Day, Good Friday, Memorial Day, July 4th, Labor Day, Columbus Day, Veterans' Day, Thanksgiving Day and the day after, Christmas Day. Sunday holidays observed the following Monday.

**NEW JERSEY DEPARTMENT OF LABOR AND WORKFORCE DEVELOPMENT
PREVAILING WAGE RATE DETERMINATION**

County - UNION

Craft: Tile Setter - Ceramic **PREVAILING WAGE RATE**

	08/27/15	12/07/15	06/06/16	12/05/16
Finisher	W41.98	W0.00	W0.00	W0.00
	B28.01	B0.00	B0.00	B0.00
	T69.99	T70.81	T71.63	T72.45
Setter	W54.31	W0.00	W0.00	W0.00
	B30.82	B0.00	B0.00	B0.00
	T85.13	T86.26	T87.39	T88.52

Expiration Date: 06/01/2017

Craft: Tile Setter - Ceramic **APPRENTICE RATE SCHEDULE**

INTERVAL	PERIOD AND RATES									
	50%	55%	60%	65%	70%	75%	85%	95%	100%	
750 Hours										

Ratio of Apprentices to Journeymen - 1:4

Craft: Tile Setter - Ceramic **COMMENTS/NOTES**

OVERTIME:

Hours in excess of 7 per day, and the first 10 hours on Saturdays shall be paid at time and one-half the hourly rate. All hours on Saturdays after 10 hours shall be paid double the hourly rate. All hours on Sundays and holidays shall be paid at double the hourly rate.

RECOGNIZED HOLIDAYS: New Year's Day, Memorial Day, July 4th, Labor Day, Thanksgiving Day, Christmas Day.

**NEW JERSEY DEPARTMENT OF LABOR AND WORKFORCE DEVELOPMENT
PREVAILING WAGE RATE DETERMINATION**

County - UNION

Craft: Tile Setter - Marble

PREVAILING WAGE RATE

	07/01/15	01/01/16	07/01/16	01/01/17	07/01/17	01/01/18
Tile Setter	W56.53	W56.89	W57.32	W57.74	W58.18	W58.53
	B31.32	B32.21	B33.23	B34.26	B35.27	B36.37
	T87.85	T89.10	T90.55	T92.00	T93.45	T94.90

Expiration Date: 06/30/2018

Craft: Tile Setter - Marble

APPRENTICE RATE SCHEDULE

INTERVAL	PERIOD AND RATES									
	50%	55%	65%	70%	75%	85%	90%	95%		
750 Hours										

Ratio of Apprentices to Journeymen - 1:4

Craft: Tile Setter - Marble

COMMENTS/NOTES

OVERTIME:

Hours in excess of 7 per day, Monday through Friday, and the first 7 hours on Saturdays shall be paid at time and one-half the regular rate, inclusive of benefits. Hours in excess of 7 on Saturdays, and all hours on Sundays and holidays shall be paid at double the regular rate, inclusive of benefits.

RECOGNIZED HOLIDAYS: New Year's Day, Presidents' Day, Good Friday, Memorial Day, July 4th, Labor Day, Columbus Day, Veterans' Day, Thanksgiving Day and the day after, Christmas Day. Sunday holidays observed the following Monday.

**NEW JERSEY DEPARTMENT OF LABOR AND WORKFORCE DEVELOPMENT
PREVAILING WAGE RATE DETERMINATION**

County - UNION

Craft: Tile Setter - Mosaic & Terrazzo

PREVAILING WAGE RATE

	08/27/15	01/01/16	07/01/16	01/01/17
Grinder or Assistant	W49.10	W0.00	W0.00	W0.00
	B32.45	B0.00	B0.00	B0.00
	T81.55	T82.70	T83.85	T85.00
Mechanic	W50.71	W0.00	W0.00	W0.00
	B32.46	B0.00	B0.00	B0.00
	T83.17	T84.32	T85.47	T86.62

Expiration Date: 06/30/2017

Craft: Tile Setter - Mosaic & Terrazzo

APPRENTICE RATE SCHEDULE

INTERVAL	PERIOD AND RATES									
	50%	55%	65%	70%	75%	85%	90%	95%		
750 Hours										

Ratio of Apprentices to Journeymen - 1:5

Craft: Tile Setter - Mosaic & Terrazzo

COMMENTS/NOTES

The regular workday consists of 7 hours, between 8:00 AM and 3:30 PM.

OVERTIME:

- Hours in excess of 7 per day, or before or after the regular workday, Monday through Friday, and all hours on Saturdays shall be paid at time and one-half the hourly rate. All hours on Sundays and holidays shall be paid at double the hourly rate.

RECOGNIZED HOLIDAYS: New Year's Day, Presidents' Day, Good Friday, Monday after Easter, Memorial Day, July 4th, Labor Day, Columbus Day, Veterans' Day, Thanksgiving Day and the day after, Christmas Day. Sunday holidays observed the following Monday.

**NEW JERSEY DEPARTMENT OF LABOR AND WORKFORCE DEVELOPMENT
PREVAILING WAGE RATE DETERMINATION**

County - UNION

Craft: Truck Driver

PREVAILING WAGE RATE

	05/01/15	11/01/15
Bucket, Utility, Pick-up, Fuel Delivery trucks	W0.00 B0.00 T67.57	W0.00 B0.00 T68.07
Dump truck, Asphalt Distributor, Tack Spreader	W0.00 B0.00 T67.57	W0.00 B0.00 T68.07
Euclid-type vehicles (large, off-road equipment)	W0.00 B0.00 T67.72	W0.00 B0.00 T68.22
Helper on Asphalt Distributor truck	W0.00 B0.00 T67.57	W0.00 B0.00 T68.07
Slurry Seal, Seeding/Fertilizing/ Mulching truck	W0.00 B0.00 T67.57	W0.00 B0.00 T68.07
Straight 3-axle truck	W0.00 B0.00 T67.62	W0.00 B0.00 T68.12
Tractor Trailer (all types)	W0.00 B0.00 T67.72	W0.00 B0.00 T68.22
Vacuum or Vac-All truck (entire unit)	W0.00 B0.00 T67.57	W0.00 B0.00 T68.07
Winch Trailer	W0.00 B0.00 T67.82	W0.00 B0.00 T68.32

Expiration Date: 04/30/2016

Craft: Truck Driver

COMMENTS/NOTES

BLENDED RATE:

When a truck driver is performing work on the site and also serving as a material delivery driver, the driver shall be paid a "blended rate" which shall be 80% of the above-listed wage rates, plus the full benefit rate. This rate shall be used when the driver "round robins" for a minimum of 6 hours during the work day.

HAZARDOUS WASTE REMOVAL:

- On hazardous waste removal work on a State designated hazardous waste site where the driver is in direct contact with hazardous materials and when personal protective equipment is required for respiratory, skin, and eye protection, the driver shall receive an additional \$3.00 per hour (with or without protective gear).
- A hazardous waste related certified worker at a designated hazardous waste site who is not working in a zone requiring level A, B or C personal protection shall receive an additional \$1.00 per hour.

TRUCK FOREMAN: \$.75 cents per hour above regular rate. Overtime shall be increased accordingly.

**NEW JERSEY DEPARTMENT OF LABOR AND WORKFORCE DEVELOPMENT
PREVAILING WAGE RATE DETERMINATION**

County - UNION

The regular workday shall be 8 hours, starting between 6:00 AM and 8:00 AM.

SHIFT DIFFERENTIAL:

- Shifts starting at 4:00 PM (2nd Shift): + \$2.50 per hour.
- Shifts starting at 12:00 AM (midnight/3rd Shift): time and one-half the hourly rate.
- Shifts starting at a time other than from 6:00 AM to 8:00 AM, when such hours are mandated by the project owner: + \$2.50 per hour.

OVERTIME:

- Hours in excess of 8 per day, or before or after the regular workday, Monday through Friday, that are not shift work, and all hours on Saturdays shall be paid at time and one-half the hourly rate. All hours on Sundays and holidays shall be paid at double the hourly rate.
- Employees may work four 10-hour days at straight time, Monday through Thursday, with Friday used as a make-up day for a lost day. If Friday is not a make-up day, then all hours on Friday shall be paid at time and one-half the hourly rate.

RECOGNIZED HOLIDAYS: New Year's Day, Presidents' Day, Memorial Day (Decoration Day), July 4th, Labor Day, Presidential Election Day, Veterans' Day, Thanksgiving Day, Christmas Day. Sunday holidays will be observed the following Monday. The day after Thanksgiving may be substituted for Veterans' Day.

**NEW JERSEY DEPARTMENT OF LABOR AND WORKFORCE DEVELOPMENT
PREVAILING WAGE RATE DETERMINATION**

County - UNION

Craft: Truck Driver-Material Delivery Driver

PREVAILING WAGE RATE

	05/01/12
Driver	W22.90 B10.17 T33.07

Expiration Date: 05/30/2016

Craft: Truck Driver-Material Delivery Driver

COMMENTS/NOTES

BLENDED RATE:

When a truck driver is performing work on the site and also serving as a material delivery driver, the driver shall be paid a "blended rate". See the "Truck Driver" craft for the blended rates.

Truck Foreman/Shop Steward: +\$0.25 per hour

SHIFT DIFFERENTIALS:

- 2nd Shift shall receive an additional \$0.50 per hour
- 3rd Shift shall receive time and one-half the hourly rate.

OVERTIME:

- Hours in excess of 8 per day, or before or after the regular workday that are not shift work, Monday through Friday, and all hours on Saturday shall be paid at time and one-half the hourly rate. All hours on Sundays shall be paid at two and one-half times the hourly rate. All hours on holidays shall be paid at double the hourly rate.

RECOGNIZED HOLIDAYS: New Year's Day, President's Day, Memorial Day (Decoration Day), July 4th, Labor Day, Presidential Election Day, Veterans' Day, Thanksgiving Day, Christmas Day. Sunday holidays will be observed the following Monday. The day after Thanksgiving may be substituted for Veterans' Day.

**NEW JERSEY DEPARTMENT OF LABOR AND WORKFORCE DEVELOPMENT
PREVAILING WAGE RATE DETERMINATION**

County - UNION

Craft: Welder

PREVAILING WAGE RATE

Welder

Expiration Date:

Craft: Welder

COMMENTS/NOTES

Welders rate is the same as the craft to which the welding is incidental .

STATEWIDE RATES

OPERATING ENGINEERS Rates Expiration Date : 06/30/2017

{For apprentice rates refer to "Operating Engineers" apprentice rates in any county rate package}

On all machines, including pile drivers with booms of 100 feet and over (including jib) the Operating Engineer shall receive the regular hourly rate plus: \$1.00 per hour on rigs with 100 foot Boom (including jib) up to 139 feet, and \$2.00 per hour on rigs with 140 foot Boom (including jib) and over. On all hoists where "Cat Head" or "Sheave Point" is 100 feet or more above ground level, the same differential pay shall apply as applicable to booms 100 feet and over.

The regular workday consists of 8 hours, Monday to Friday, between 6:00 AM and 4:30 PM.

SHIFT DIFFERENTIALS:

- Shift work must run for 5 consecutive workdays.
- When 2 shifts are worked, the second shift shall receive an additional 10% of the regular rate inclusive of benefits, per hour.
- When 3 shifts are worked, the second shift shall receive 8 hours pay for 7.5 hours of work, plus an additional 10% of the regular rate inclusive of benefits, per hour. The third shift shall receive 8 hours pay for 7 hours of work, plus an additional 15% of the regular rate inclusive of benefits, per hour.
- When such hours are mandated by the project owner, a shift that starts between 8:00 PM and midnight and ends by 6:00 AM Saturday, or that starts after 8:00 PM on Sunday, provided there are consecutive hours of work within the shift, shall receive an additional 15% of the regular rate, inclusive of benefits.
- On Highway, Road, Street, and Sewer projects irregular shifts starting between 5:00 PM and 12:00 AM may be worked Monday through Friday, and shall receive an additional 15% of the regular rate, inclusive of benefits. When working with other trades that receive a higher irregular shift rate, the Operating Engineer shall also receive the higher irregular shift rate.

OVERTIME:

- Hours in excess of 8 per day, or outside of the regular workday, Monday through Friday, that are not shift work, and all hours on Saturdays shall be paid at time and one-half the regular rate, inclusive of benefits. All hours on Sundays and holidays shall be paid at double the regular rate, inclusive of benefits.
- Four 10-hour days may be worked, Monday through Thursday, at straight time, with all hours on Friday paid at time and one-half the regular rate, inclusive of benefits.

RECOGNIZED HOLIDAYS: New Year's Day, Presidents' Day, Memorial Day, July 4th, Labor Day, Veterans' Day, Thanksgiving Day, Christmas Day. Sunday holidays observed the following Monday.

On hazardous waste removal work or asbestos removal work, on a state or federally designated hazardous waste site, where the operating engineer is in direct contact with hazardous material and when personal protective equipment is required for respiratory, skin, and eye protection, the operating engineer shall receive an additional 20% of the hourly wage, per hour.

OPERATING ENGINEERS **Rates Expiration Date : 06/30/2017**

Effective Dates:

	07/23/2015		01/01/2016	07/01/2016	01/01/2017
Rate	Fringe	Total	Total	Total	Total
45.48	29.48	74.96	76.11	77.11	78.26

CLASSIFICATIONS:

- A-Frame
- Backhoe (combination)
- Boom Attachment on loaders (Except pipehook)
- Boring & Drilling Machine
- Brush Chopper, Brush Shredder, Tree Shredder
- Bulldozer, finish grade
- Cableway
- Carryall
- Concrete Pump
- Concrete Pumping System (Pumpcrete & similar types)
- Conveyor, 125 feet or longer
- Drill Doctor (Duties include dust collector and maintenance)
- Front End Loader (2 cu. yds. but less than 5 cu. yds.)
- Grader, finish
- Groove Cutting Machine (ride-on type)
- Heater Planer
- Hoist (all types including steam, gas, diesel, electric, air hydraulic, single and double drum, concrete, brick shaft caisson, snorkle roof, and other similar types, Except Chicago-boom type)
- Hydraulic Crane (10 tons & under)
- Hydro-Axe
- Hydro-Blaster
- Jack (screw, air hydraulic, power-operated unit, or console type, Except hand jack or pile load test type)
- Log Skidder

OPERATING ENGINEERS **Rates Expiration Date : 06/30/2017**

Effective Dates:

07/23/2015			01/01/2016	07/01/2016	01/01/2017
Rate	Fringe	Total	Total	Total	Total
45.48	29.48	74.96	76.11	77.11	78.26

CLASSIFICATIONS:

- Pan
- Paver, concrete
- Plate & Frame Filter Press
- Pumpcrete (unit type)
- Pumpcrete, Squeezecrete, or Concrete Pumping machine (regardless of size)
- Scraper
- Side Boom
- Straddle Carrier (Ross and similar types)
- Vacuum Truck
- Whiphammer
- Winch Truck (hoisting)

OPERATING ENGINEERS **Rates Expiration Date : 06/30/2017**

Effective Dates:

	07/23/2015		01/01/2016	07/01/2016	01/01/2017
Rate	Fringe	Total	Total	Total	Total
43.57	29.48	73.05	74.60	75.20	76.35

CLASSIFICATIONS:

- Asphalt Curbing Machine
- Asphalt Plant Engineer
- Asphalt Spreader
- Autograde Curb Trimmer & Sidewalk Shoulder Slipform (CMI & similar types)
- Autograde Curecrete Machine (CMI & similar types)
- Autograde Tube Finisher & Texturing Machine (CMI & similar types)
- Bar Bending Machines (Power)
- Batcher, Batching Plant, & Crusher [On Site]
- Belt Conveyor System
- Boom-Type Skimmer Machine
- Bridge Deck Finisher
- Bulldozer (all sizes)
- Captain (Power Boats)
- Car Dumper (railroad)
- Compressor & Blower unit for loading/unloading of concrete, cement, fly ash, or similar type materials (used independently or truck-mounted)
- Compressor (2 or 3 battery)
- Concrete Breaking Machine
- Concrete Cleaning/Decontamination Machine
- Concrete Finishing Machine
- Concrete Saw or Cutter (ride-on type)
- Concrete Spreader (Hetzl, Rexomatic & similar types)
- Concrete Vibrator

OPERATING ENGINEERS **Rates Expiration Date : 06/30/2017**

Effective Dates:

	07/23/2015		01/01/2016	07/01/2016	01/01/2017
Rate	Fringe	Total	Total	Total	Total
43.57	29.48	73.05	74.60	75.20	76.35

CLASSIFICATIONS:

- Conveyors - under 125 feet
- Crane Signalman
- Crushing Machine
- Directional Boring Machine
- Ditching Machine - Small (Ditchwitch, Vermeer or similar types)
- Dope Pot - Mechanical (with or without pump)
- Dumpster
- Elevator
- Fireman
- Fork Lift (Economobile, Lull & similar types)
- Front End Loader (1 cu. yd. and over but less than 2 cu. yds.)
- Generator (2 or 3 battery)
- Giraffe Grinder
- Grader & Motor Patrols
- Grout Pump
- Gunnite Machine (Excluding nozzle)
- Hammer - Vibratory (in conjunction with generator)
- Heavy Equipment Robotics - Operator/Technician
- Hoist (roof, tugger, aerial platform hoist, house car)
- Hopper
- Hopper Doors (power operated)
- Ladder (motorized)
- Laddervator

OPERATING ENGINEERS **Rates Expiration Date : 06/30/2017**

Effective Dates:

07/23/2015			01/01/2016	07/01/2016	01/01/2017
Rate	Fringe	Total	Total	Total	Total
43.57	29.48	73.05	74.60	75.20	76.35

CLASSIFICATIONS:

Locomotive (Dinky-type)

Maintenance Utility Man

Master Environmental Maintenance Technician

Mechanic

Mixer (Except paving mixers)

Pavement Breaker (truck-mounted or small self-propelled ride-on type)

Pavement Breaker - maintenance of compressor or hydraulic unit

Pipe Bending Machine (power)

Pitch Pump

Plaster Pump (regardless of size)

Post Hole Digger (post pounder, auger)

Roller (black top)

Scale (power)

Seamen Pulverizing Mixer

Shoulder Widener

Silo

Skimmer Machine (boom type)

Steel Cutting Machine (service & maintenance)

Tamrock Drill

Tractor

Transfer Machines

Tug Captains

Tug Master (Power Boats)

OPERATING ENGINEERS **Rates Expiration Date : 06/30/2017**

Effective Dates:

07/23/2015			01/01/2016	07/01/2016	01/01/2017
Rate	Fringe	Total	Total	Total	Total
43.57	29.48	73.05	74.60	75.20	76.35

CLASSIFICATIONS:

Ultra High Pressure Waterjet Cutting Tool System -
Operator/Maintenance Technician

Vacuum Blasting Machine - Operator/Maintenance Technician

Vibrating Plant (used with unloading)

Welder & Repair Mechanic

Effective Dates:

07/23/2015			01/01/2016	07/01/2016	01/01/2017
Rate	Fringe	Total	Total	Total	Total
40.23	29.48	69.71	70.86	71.86	73.01

CLASSIFICATIONS:

Assistant Engineer/Oiler

Driller's Helper

Field Engineer - Transit man or Instrument man

Maintenance Apprentice (Deckhand)

Maintenance Apprentice (Oiler)

Mechanic's Helper

Off Road Back Dump

Effective Dates:

07/23/2015			01/01/2016	07/01/2016	01/01/2017
Rate	Fringe	Total	Total	Total	Total
37.65	29.48	67.13	68.28	69.28	70.43

CLASSIFICATIONS:

Field Engineer - Rodman or Chainman

TERRITORY
ENTIRE STATE

NEW JERSEY DEPARTMENT OF LABOR AND WORKFORCE DEVELOPMENT
PREVAILING WAGE RATE DETERMINATION

OPERATING ENGINEERS Rates Expiration Date : 06/30/2017

Effective Dates:

07/23/2015			01/01/2016	07/01/2016	01/01/2017
Rate	Fringe	Total	Total	Total	Total
47.81	29.48	77.29	78.44	79.44	80.59

CLASSIFICATIONS:

Lead Engineer, Foreman Engineer, Safety Engineer (minimum)

OPERATING ENGINEERS **Rates Expiration Date : 06/30/2017**

Effective Dates:

07/23/2015			01/01/2016	07/01/2016	01/01/2017
Rate	Fringe	Total	Total	Total	Total
47.07	29.48	76.55	77.70	78.70	79.85

CLASSIFICATIONS:

- Autograde Pavement Profiler (CMI & similar types)
- Autograde Pavement Profiler - Recycle Type (CMI & similar types)
- Autograde Placer/Trimmer/Spreader Combination (CMI & similar types)
- Autograde Slipform Paver (CMI & similar types)
- Backhoe (Excavator)
- Central Power Plant
- Concrete Paving Machine
- Draglines
- Drill, Bauer, AMI and similar types
- Drillmaster, Quarrymaster
- Drillmaster/Quarrymaster (down-the-hole drill), rotary drill, self-propelled hydraulic drill, self-powered drill
- Elevator Grader
- Field Engineer-Chief of Party
- Front End Loader (5 cu. yards or larger)
- Gradall
- Grader, Rago
- Helicopter Co-Pilot
- Helicopter Communications Engineer
- Juntann Pile Driver
- Locomotive (large)
- Mucking Machine
- Pavement & Concrete Breaker (Superhammer & Hoe Ram)

OPERATING ENGINEERS **Rates Expiration Date : 06/30/2017**

Effective Dates:

	07/23/2015		01/01/2016	07/01/2016	01/01/2017
Rate	Fringe	Total	Total	Total	Total
47.07	29.48	76.55	77.70	78.70	79.85

CLASSIFICATIONS:

Pile Driver

Prentice Truck

Roadway Surface Grinder

Scooper (loader & shovel)

Shovel (Excavator)

Trackhoe (Excavator)

Tree Chopper with boom

Trenching Machine (cable plow)

Tunnel Boring Machine

OPERATING ENGINEERS **Rates Expiration Date : 06/30/2017**

Effective Dates:

	07/23/2015		01/01/2016	07/01/2016	01/01/2017
Rate	Fringe	Total	Total	Total	Total
41.94	29.48	71.42	72.57	73.57	74.72

CLASSIFICATIONS:

- Chipper
- Compressor (single)
- Concrete Spreader (small type)
- Conveyor Loader (Except elevator graders)
- Engines, Large Diesel (1620 HP) & Staging Pump
- Farm Tractor
- Fertilizing Equipment (operation & maintenance)
- Fine Grade Machine (small type)
- Form Line Grader (small type)
- Front End Loader (under 1 cubic yard)
- Generator (single)
- Grease, Gas, Fuel, & Oil Supply Trucks
- Heaters (Nelson or other type)
- Lights - portable generating light plant
- Mixer, Concrete (small)
- Mulching Equipment (operation & maintenance)
- Power Broom or Sweeper
- Pump (diesel engine & hydraulic - regardless of power)
- Pump (larger than 2 inch suction, including submersible pumps)
- Road Finishing Machine (small type)
- Roller - grade, fill, or stone base
- Seeding Equipment (operation & maintenance)
- Sprinkler & Water Pump Trucks

OPERATING ENGINEERS Rates Expiration Date : 06/30/2017

Effective Dates:

07/23/2015			01/01/2016	07/01/2016	01/01/2017
Rate	Fringe	Total	Total	Total	Total
41.94	29.48	71.42	72.57	73.57	74.72

CLASSIFICATIONS:

Steam Generator or Boiler

Stone Spreader

Tamping Machine (vibrating ride-on type)

Temporary Heating Plant (Nelson or other type, including propane, natural gas, and flow-type units)

Water or Sprinkler Truck

Welding Machine (gas, diesel, or electric convertor, of any type)

Welding System - Multiple (rectifier transformer type)

Wellpoint Systems (including installation by bull gang and maintenance)

Effective Dates:

07/23/2015			01/01/2016	07/01/2016	01/01/2017
Rate	Fringe	Total	Total	Total	Total
48.89	29.48	78.37	79.52	80.52	81.67

CLASSIFICATIONS:

Helicopter Pilot/Engineer

Effective Dates:

07/23/2015			01/01/2016	07/01/2016	01/01/2017
Rate	Fringe	Total	Total	Total	Total
50.32	29.48	79.80	80.95	81.95	83.10

CLASSIFICATIONS:

Cranes, Derricks, Pile Driver (all types), over 100 tons and TOWER CRANE with boom (including jib and/or leads) 140 ft. and over

Effective Dates:

07/23/2015			01/01/2016	07/01/2016	01/01/2017
Rate	Fringe	Total	Total	Total	Total
49.32	29.48	78.80	79.95	80.95	82.10

CLASSIFICATIONS:

Cranes, Derricks, Pile Driver (all types), over 100 tons and TOWER CRANE with boom (including jib and/or leads) from 100 ft. to 139 ft.

OPERATING ENGINEERS **Rates Expiration Date : 06/30/2017**

Effective Dates:

07/23/2015			01/01/2016	07/01/2016	01/01/2017
Rate	Fringe	Total	Total	Total	Total
49.07	29.48	78.55	79.70	80.70	81.85

CLASSIFICATIONS:

Cranes, Derricks, Pile Driver (all types) , under 100 tons with a boom (including jib and/or leads) 140 ft. and over

Effective Dates:

07/23/2015			01/01/2016	07/01/2016	01/01/2017
Rate	Fringe	Total	Total	Total	Total
48.32	29.48	77.80	78.95	79.95	81.10

CLASSIFICATIONS:

Cranes, Derricks, Pile Driver (all types), over 100 tons and TOWER CRANE with a boom (including jib and/or leads) under 100 ft.

Effective Dates:

07/23/2015			01/01/2016	07/01/2016	01/01/2017
Rate	Fringe	Total	Total	Total	Total
48.07	29.48	77.55	78.70	79.70	80.85

CLASSIFICATIONS:

Cranes, Derricks, Pile Driver (all types), under 100 tons with a boom (including jib and/or leads) from 100 ft. to 139 ft.

STRUCTURAL STEEL ERECTION Rates Expiration Date : 06/30/2017

{For apprentice rates refer to "Operating Engineers" apprentice rates in any county rate package}

The regular workday consists of 8 hours, Monday to Friday, between 6:00 AM and 4:30 PM.

SHIFT DIFFERENTIALS:

- Shift work must run for 5 consecutive workdays.
- When 2 shifts are worked, the second shift shall receive an additional 10% of the regular rate inclusive of benefits, per hour.
- When 3 shifts are worked, the second shift shall receive 8 hours pay for 7.5 hours of work, plus an additional 10% of the regular rate inclusive of benefits, per hour. The third shift shall receive 8 hours pay for 7 hours of work, plus an additional 15% of the regular rate inclusive of benefits, per hour.
- When such hours are mandated by the project owner, a shift that starts between 8:00 PM and midnight and ends by 6:00 AM Saturday, or that starts after 8:00 PM on Sunday, provided there are consecutive hours of work within the shift, shall receive an additional 15% of the regular rate, inclusive of benefits.
- On Highway, Road, Street, and Sewer projects irregular shifts starting between 5:00 PM and 12:00 AM may be worked Monday through Friday, and shall receive an additional 15% of the regular rate, inclusive of benefits. When working with other trades that receive a higher irregular shift rate, the Operating Engineer shall also receive the higher irregular shift rate.

OVERTIME:

- Hours in excess of 8 per day, or outside of the regular workday, Monday through Friday, that are not shift work, and all hours on Saturdays shall be paid at time and one-half the regular rate, inclusive of benefits. All hours on Sundays and holidays shall be paid at double the regular rate, inclusive of benefits.
- Four 10-hour days may be worked, Monday through Thursday, at straight time, with all hours on Friday paid at time and one-half the regular rate, inclusive of benefits.

RECOGNIZED HOLIDAYS: New Year's Day, Presidents' Day, Memorial Day, July 4th, Labor Day, Veterans' Day, Thanksgiving Day, Christmas Day. Sunday holidays observed the following Monday.

On hazardous waste removal work or asbestos removal work, on a state or federally designated hazardous waste site, where the operating engineer is in direct contact with hazardous material and when personal protective equipment is required for respiratory, skin, and eye protection, the operating engineer shall receive an additional 20% of the hourly wage, per hour.

Effective Dates:

	07/23/2015		01/01/2016	07/01/2016	01/01/2017
Rate	Fringe	Total	Total	Total	Total
50.70	29.48	80.18	81.33	82.33	83.48

CLASSIFICATIONS:

Helicopter Pilot or Engineer

STRUCTURAL STEEL ERECTION **Rates Expiration Date : 06/30/2017**

Effective Dates:

07/23/2015			01/01/2016	07/01/2016	01/01/2017
Rate	Fringe	Total	Total	Total	Total
46.64	29.48	76.12	77.27	78.27	79.42

CLASSIFICATIONS:

A-Frame

Cherry Picker -10 tons or less (Over 10 tons use crane rate)

Hoist (all types Except Chicago-boom)

Jack (screw, air hydraulic, power-operated unit or console type, Except hand jack or pile load test type)

Side Boom

Straddle Carrier

Effective Dates:

07/23/2015			01/01/2016	07/01/2016	01/01/2017
Rate	Fringe	Total	Total	Total	Total
43.98	29.48	73.46	74.61	75.61	76.76

CLASSIFICATIONS:

Aerial Platform Used On Hoists

Apprentice Engineer/Oiler with Compressor or Welding Machine

Captain (Power Boats)

Compressor (2 or 3 in battery)

Conveyor or Tugger Hoist

Elevator or House Car

Fireman

Forklift

Generator (2 or 3)

Maintenance Utility Man

Tug Master (Power Boats)

Welding Machines, Gas or Electric Converters on any type-2 or 3 in battery including diesels

STRUCTURAL STEEL ERECTION **Rates Expiration Date : 06/30/2017**

Effective Dates:

07/23/2015			01/01/2016	07/01/2016	01/01/2017
Rate	Fringe	Total	Total	Total	Total
42.45	29.48	71.93	73.08	74.08	75.23

CLASSIFICATIONS:

Compressor (Single)

Generators

Welding Machines, Gas, Diesel, Or Electric Converters of any type-single

Welding System, Multiple (Rectifier Transformer Type)

Effective Dates:

07/23/2015			01/01/2016	07/01/2016	01/01/2017
Rate	Fringe	Total	Total	Total	Total
40.69	29.48	70.17	71.32	72.32	73.47

CLASSIFICATIONS:

Assistant Engineer/Oiler

Drillers Helper

Field Engineer - Transit/Instrument Man

Maintenance Apprentice (Deckhand)

Maintenance Apprentice (Oiler)

Effective Dates:

07/23/2015			01/01/2016	07/01/2016	01/01/2017
Rate	Fringe	Total	Total	Total	Total
48.26	29.48	77.74	78.89	79.89	81.04

CLASSIFICATIONS:

Lead Engineer, Foreman Engineer, Safety Engineer (Minimum)

Effective Dates:

07/23/2015			01/01/2016	07/01/2016	01/01/2017
Rate	Fringe	Total	Total	Total	Total
37.65	29.48	67.13	68.28	69.28	70.43

CLASSIFICATIONS:

Field Engineer - Rodman or Chainman

STRUCTURAL STEEL ERECTION **Rates Expiration Date : 06/30/2017**

Effective Dates:

07/23/2015			01/01/2016	07/01/2016	01/01/2017
Rate	Fringe	Total	Total	Total	Total
47.40	29.48	76.88	78.03	79.03	80.18

CLASSIFICATIONS:

Field Engineer-Chief of Party

Effective Dates:

07/23/2015			01/01/2016	07/01/2016	01/01/2017
Rate	Fringe	Total	Total	Total	Total
53.34	29.48	82.82	83.97	84.97	86.12

CLASSIFICATIONS:

Cranes (all cranes, land or floating with booms, including jib, 140 ft. and over, above ground). Derricks (all derricks, land, floating or Chicago Boom type with booms including jib, 140 ft. and over, above ground), and Pile Drivers (all types) over 100 tons and Tower Cranes.

Effective Dates:

07/23/2015			01/01/2016	07/01/2016	01/01/2017
Rate	Fringe	Total	Total	Total	Total
51.68	29.48	81.16	82.31	83.31	84.46

CLASSIFICATIONS:

Cranes (all cranes, land or floating with booms including jib, less than 140 ft. above ground), Derricks (all derricks, land, floating or Chicago Boom type with booms including jib, less than 140 ft. above ground), Pile Drivers (all types), over 100 tons and Tower Crane.

Effective Dates:

07/23/2015			01/01/2016	07/01/2016	01/01/2017
Rate	Fringe	Total	Total	Total	Total
51.09	29.48	80.57	81.72	82.72	83.87

CLASSIFICATIONS:

Cranes (all cranes, land or floating with booms including jib, 140 ft. and over, above ground), Derricks (all derricks, land, floating or Chicago Boom type with booms including jib, 140 ft. and over, above ground), Pile Drivers (all types), under 100 tons.

Effective Dates:

07/23/2015			01/01/2016	07/01/2016	01/01/2017
Rate	Fringe	Total	Total	Total	Total
49.43	29.48	78.91	80.06	81.06	82.21

CLASSIFICATIONS:

Cranes (all cranes, land or floating with booms including jib, less than 140 ft. above ground), Derricks (all derricks, land, floating or Chicago Boom type with booms including jib, less than 140 ft. above ground), Pile Drivers (all types), under 100 tons.

TERRITORY
ENTIRE STATE

NEW JERSEY DEPARTMENT OF LABOR AND WORKFORCE DEVELOPMENT
PREVAILING WAGE RATE DETERMINATION

STRUCTURAL STEEL ERECTION Rates Expiration Date : 06/30/2017

Effective Dates:

07/23/2015			01/01/2016	07/01/2016	01/01/2017
Rate	Fringe	Total	Total	Total	Total
51.09	29.48	80.57	81.72	82.72	83.87

CLASSIFICATIONS:

Helicopter Co-Pilot

Helicopter Communications Engineer

TEST BORING PRELIMINARY TO CONSTRUCTION-SOUTH/WEST Rates Expiration Date : 06/30/2017

THESE RATES APPLY IN THE FOLLOWING COUNTIES ONLY:

Atlantic, Burlington, Camden, Cape May, Cumberland, Gloucester, Hunterdon, Mercer, Monmouth, Ocean, Salem, Sussex, Warren

On all machines, including pile drivers with booms of 100 feet and over (including jib) the Operating Engineer shall receive the regular hourly rate plus: \$1.00 per hour on rigs with 100 foot Boom (including jib) up to 139 feet, and \$2.00 per hour on rigs with 140 foot Boom (including jib) and over. On all hoists where "Cat Head" or "Sheave Point" is 100 feet or more above ground level, the same differential pay shall apply as applicable to booms 100 feet and over.

The regular workday consists of 8 hours, Monday to Friday, between 6:00 AM and 4:30 PM.

SHIFT DIFFERENTIALS:

- Shift work must run for 5 consecutive workdays.
- When 2 shifts are worked, the second shift shall receive an additional 10% of the regular rate inclusive of benefits, per hour.
- When 3 shifts are worked, the second shift shall receive 8 hours pay for 7.5 hours of work, plus an additional 10% of the regular rate inclusive of benefits, per hour. The third shift shall receive 8 hours pay for 7 hours of work, plus an additional 15% of the regular rate inclusive of benefits, per hour.
- When such hours are mandated by the project owner, a shift that starts between 8:00 PM and midnight and ends by 6:00 AM Saturday, or that starts after 8:00 PM on Sunday, provided there are consecutive hours of work within the shift, shall receive an additional 15% of the regular rate, inclusive of benefits.
- On Highway, Road, Street, and Sewer projects irregular shifts starting between 5:00 PM and 12:00 AM may be worked Monday through Friday, and shall receive an additional 15% of the regular rate, inclusive of benefits. When working with other trades that receive a higher irregular shift rate, the Operating Engineer shall also receive the higher irregular shift rate.

OVERTIME:

- Hours in excess of 8 per day, or outside of the regular workday, Monday through Friday, that are not shift work, and all hours on Saturdays shall be paid at time and one-half the regular rate, inclusive of benefits. All hours on Sundays and holidays shall be paid at double the regular rate, inclusive of benefits.
- Four 10-hour days may be worked, Monday through Thursday, at straight time, with all hours on Friday paid at time and one-half the regular rate, inclusive of benefits.

RECOGNIZED HOLIDAYS: New Year's Day, Presidents' Day, Memorial Day, July 4th, Labor Day, Veterans' Day, Thanksgiving Day, Christmas Day. Sunday holidays observed the following Monday.

On hazardous waste removal work or asbestos removal work, on a state or federally designated hazardous waste site, where the operating engineer is in direct contact with hazardous material and when personal protective equipment is required for respiratory, skin, and eye protection, the operating engineer shall receive an additional 20% of the hourly wage, per hour.

Effective Dates:

	07/23/2015		01/01/2016	07/01/2016	01/01/2017
Rate	Fringe	Total	Total	Total	Total
47.07	29.48	76.55	77.70	78.70	79.85

CLASSIFICATIONS:

Driller

TERRITORY
ENTIRE STATE

NEW JERSEY DEPARTMENT OF LABOR AND WORKFORCE DEVELOPMENT
PREVAILING WAGE RATE DETERMINATION

TEST BORING PRELIMINARY TO CONSTRUCTION-SOUTH/WEST Rates Expiration Date : 06/30/2017

Effective Dates:

07/23/2015			01/01/2016	07/01/2016	01/01/2017
Rate	Fringe	Total	Total	Total	Total
40.23	29.48	69.71	70.86	71.86	73.01

CLASSIFICATIONS:

Driller's Helper

FREE AIR TUNNEL JOBS Rates Expiration Date : 08/31/2017

{For apprentice rates refer to "Heavy & General" apprentice rates in any county rate package}

The regular workday consists of 8 hours, starting at 7:00 AM or 8:00 AM.

SHIFT DIFFERENTIALS:

- Shifts must start at 3:00 PM, 4:00 PM, 12:00 AM, or 1:00 AM, to be considered shift work, except when the project owner mandates special hours of work in the job specifications, in which case those hours may be considered shift work.
- When such hours are mandated by the project owner, a shift that begins before midnight on Friday and ends on Saturday morning, or that begins at or after 8:00 PM on Sunday and ends on Monday morning may be paid at the shift differential rate.
- Shifts shall receive an additional \$2.50 per hour.

OVERTIME:

- Hours in excess of 8 per day, Monday through Friday, or outside of the regular workday that are not shift work, and all hours on Saturdays, shall be paid at time and one-half the hourly rate. All hours on Sundays and holidays shall be paid at double the hourly rate.
- Four 10-hour days may be worked, Monday through Thursday, at straight time, with Friday used as a make-up day for a day lost to inclement weather. If Friday is not a make-up day, all hours on Friday shall be paid at time and one-half the hourly rate.

RECOGNIZED HOLIDAYS: New Year's Day, Presidents' Day, Memorial Day, July 4th, Labor Day, Presidential Election Day, Veterans' Day, Thanksgiving Day, Christmas Day. Sunday holidays observed the following Monday. Veterans Day may be substituted for the day after Thanksgiving. However, in the trading of Veterans Day for the day after Thanksgiving, if overtime is worked on Veterans Day, it shall be paid at double the hourly rate.

Hazardous Waste Work:

- where Level A, B, or C protection is required: + \$3.00/hr
- other Hazardous Waste site: + \$1.00/hr

Effective Dates:

	06/05/2015		09/01/2015	03/01/2016	09/01/2016	03/01/2017
Rate	Fringe	Total	Total	Total	Total	Total
38.50	26.28	64.78	65.53	67.03	68.13	70.53

CLASSIFICATIONS:

Walking Boss & Superintendent

Effective Dates:

	06/05/2015		09/01/2015	03/01/2016	09/01/2016	03/01/2017
Rate	Fringe	Total	Total	Total	Total	Total
38.20	26.28	64.48	65.23	66.73	67.83	70.23

CLASSIFICATIONS:

Heading Foreman, Shaft Foreman, Rod Foreman, Electrician Foreman, Rigging Foreman

FREE AIR TUNNEL JOBS **Rates Expiration Date : 08/31/2017**

Effective Dates:

	06/05/2015		09/01/2015	03/01/2016	09/01/2016	03/01/2017
Rate	Fringe	Total	Total	Total	Total	Total
37.70	26.28	63.98	64.73	66.23	67.33	69.73

CLASSIFICATIONS:

Iron Foreman, Caulking Foreman, Form Foreman, Cement Finishing Foreman, Concrete Foreman, Track Foreman, Cleanup Foreman, Grout Foreman

Effective Dates:

	06/05/2015		09/01/2015	03/01/2016	09/01/2016	03/01/2017
Rate	Fringe	Total	Total	Total	Total	Total
40.20	26.28	66.48	67.23	68.73	69.83	72.23

CLASSIFICATIONS:

Blaster

Effective Dates:

	06/05/2015		09/01/2015	03/01/2016	09/01/2016	03/01/2017
Rate	Fringe	Total	Total	Total	Total	Total
37.15	26.28	63.43	64.18	65.68	66.78	69.18

CLASSIFICATIONS:

Top Labor Foreman

Effective Dates:

	06/05/2015		09/01/2015	03/01/2016	09/01/2016	03/01/2017
Rate	Fringe	Total	Total	Total	Total	Total
36.80	26.28	63.08	63.83	65.33	66.43	68.83

CLASSIFICATIONS:

Skilled Men (including Caulker, Powder Carrier, all other skilled men)

Skilled Men (including Miner, Drill Runner, Iron Man, Conveyor Man, Manintenance Man, Safety Miner, Rigger, Block Layer, Cement Finisher, Tod Man)

Effective Dates:

	06/05/2015		09/01/2015	03/01/2016	09/01/2016	03/01/2017
Rate	Fringe	Total	Total	Total	Total	Total
36.65	26.28	62.93	63.68	65.18	66.28	68.68

CLASSIFICATIONS:

Semi-Skilled Men (including Bell or Signal Man Top or Bottom, Form Worker & Mover, Concrete Worker, Shaft Man, Tunnel Laborer, Caulker's Helper, all other semi-skilled)

Semi-Skilled Men (including Miner's Helper, Chuck Tender, Track Man, Nipper, Brake Man, Derail Man, Cable Man, Hose Man, Gravel Man, Form Man)

TERRITORY
ENTIRE STATE

NEW JERSEY DEPARTMENT OF LABOR AND WORKFORCE DEVELOPMENT
PREVAILING WAGE RATE DETERMINATION

FREE AIR TUNNEL JOBS Rates Expiration Date : 08/31/2017

Effective Dates:

06/05/2015			09/01/2015	03/01/2016	09/01/2016	03/01/2017
Rate	Fringe	Total	Total	Total	Total	Total
36.15	26.28	62.43	63.18	64.68	65.78	68.18

CLASSIFICATIONS:

All Others (including Powder Watchman, Change House Attendant, Top Laborer)

DRILL FOR GROUND WATER SUPPLY **Rates Expiration Date : 06/30/2017**

The well driller and/or helper may perform all work relative to the construction, finishing, and servicing of wells, pumps and borings for ground water supply. The present methods of well drilling entailing as they do, many diverse job operations calling for drilling, pump discharge, piping, and the operation of various types of related power equipment, shall all be within the job duties and functions of the well driller and/or helper. In the event that an extension of work should occur beyond water well drilling functions, into the field of general construction work, such extension of work would come under the appropriate rates listed elsewhere in this wage determination.

- For Work Hours, Shift Differentials, Overtime Rates, and Recognized Holidays see the "Operating Engineers" section of this wage determination.

Effective Dates:

07/23/2015			01/01/2016	07/01/2016	01/01/2017
Rate	Fringe	Total	Total	Total	Total
45.82	29.48	75.30	76.45	77.45	78.60

CLASSIFICATIONS:

Driller

Effective Dates:

07/23/2015			01/01/2016	07/01/2016	01/01/2017
Rate	Fringe	Total	Total	Total	Total
38.98	29.48	68.46	89.61	70.61	71.76

CLASSIFICATIONS:

Driller's Helper

OPERATING ENGINEERS MARINE-DREDGING **Rates Expiration Date : 09/30/2015**

NOTE: Boat crews carrying explosive material (dynamite, pourfex, and other similar materials) shall be paid at 120% of the hourly wage rate for hours engaged in handling of said materials. Employees required to possess a Hazardous Material Certification as a condition of employment shall be compensated at 120% of the hourly wage rate.

OVERTIME:

Hours in excess of 40 per week, and all hours on Saturdays and Sundays, shall be paid at time and one-half the hourly rate. All hours on holidays shall be paid at double the hourly rate.

RECOGNIZED HOLIDAYS: New Year's Day, Martin Luther King Day, Good Friday, Memorial Day, July 4th, Labor Day, Veterans' Day, Thanksgiving Day, Christmas Day. Sunday holidays observed the following Monday.

Effective Dates:

10/01/2014

Rate	Fringe	Total
35.63	12.89	48.52

CLASSIFICATIONS:

Lead Dredgerman, Operator, Leverman

Licensed Tug Operator (over 1000 HP)

Effective Dates:

10/01/2014

Rate	Fringe	Total
30.81	12.50	43.31

CLASSIFICATIONS:

Derrick Operator, Spider/Spill Barge Operator

Engineer, Electrician, Chief Welder, Chief Mate

Fill Placer, Operator II

Licensed Boat Operator

Maintenance Engineer

Effective Dates:

10/01/2014

Rate	Fringe	Total
29.01	12.36	41.37

CLASSIFICATIONS:

Certified Welder

OPERATING ENGINEERS MARINE-DREDGING **Rates Expiration Date : 09/30/2015**

Effective Dates:

10/01/2014

Rate	Fringe	Total
28.22	12.00	40.22

CLASSIFICATIONS:

Mate, Drag Barge Operator, Steward, Assistant Fill Placer

Welder

Effective Dates:

10/01/2014

Rate	Fringe	Total
27.30	11.92	39.22

CLASSIFICATIONS:

Boat Operator

Effective Dates:

10/01/2014

Rate	Fringe	Total
22.68	11.25	33.93

CLASSIFICATIONS:

Shoreman, Deckhand, Rodman, Scowman

MICROSURFACING/SLURRY SEAL Rates Expiration Date : 02/28/2018

THESE RATES APPLY IN THE FOLLOWING COUNTIES ONLY:

Atlantic, Burlington, Camden, Cape May, Cumberland, Gloucester, Mercer, Ocean, Salem

IN ALL OTHER COUNTIES use the Heavy and General Laborers - North "Slurry Seal Laborer" rates.

SHIFT DIFFERENTIALS:

Any shift starting at 3:30 PM or later shall receive an additional \$0.35/hr

OVERTIME:

Hours in excess of 8 per day or 40 per week shall be paid at time and one-half the hourly rate. All hours on holidays shall be paid at double the hourly rate.

RECOGNIZED HOLIDAYS: New Year's Day, Washington's Birthday, Memorial Day, July 4th, Labor Day, Presidential Election Day, Veterans' Day, Thanksgiving Day, Christmas Day.

Effective Dates:

	03/01/2015		03/01/2016	03/01/2017
Rate	Fringe	Total	Total	Total
35.00	19.69	54.69	56.10	57.77

CLASSIFICATIONS:

Foreman

Effective Dates:

	03/01/2015		03/01/2016	03/01/2017
Rate	Fringe	Total	Total	Total
32.40	19.69	52.09	53.45	55.07

CLASSIFICATIONS:

Box man

Effective Dates:

	03/01/2015		03/01/2016	03/01/2017
Rate	Fringe	Total	Total	Total
30.40	19.69	50.09	51.45	53.02

CLASSIFICATIONS:

Microsurface/Slurry Preparation

Effective Dates:

	03/01/2015		03/01/2016	03/01/2017
Rate	Fringe	Total	Total	Total
30.40	19.69	50.09	51.45	53.02

CLASSIFICATIONS:

Squeegee man

TERRITORY
ENTIRE STATE

NEW JERSEY DEPARTMENT OF LABOR AND WORKFORCE DEVELOPMENT
PREVAILING WAGE RATE DETERMINATION

MICROSURFACING/SLURRY SEAL Rates Expiration Date : 02/28/2018

Effective Dates:

03/01/2015			03/01/2016	03/01/2017
Rate	Fringe	Total	Total	Total
28.90	19.69	48.59	49.95	51.57

CLASSIFICATIONS:

Cleaner, Taper

ASPHALT LABORERS - SOUTH **Rates Expiration Date : 08/31/2017**

"THESE RATES APPLY IN THE FOLLOWING COUNTIES ONLY: Atlantic, Burlington, Camden, Cape May, Cumberland, Gloucester, Mercer, Ocean, Salem

{For apprentice rates refer to "Laborer - Heavy & General" apprentice rates in any county rate package}

The regular workday consists of 8 hours, starting at 7:00 AM or 8:00 AM.

SHIFT DIFFERENTIALS:

- Shifts must start at 3:00 PM, 4:00 PM, 12:00 AM, or 1:00 AM, to be considered shift work, except when the project owner mandates special hours of work in the job specifications, in which case those hours may be considered shift work.
- When such hours are mandated by the project owner, a shift that begins before midnight on Friday and ends on Saturday morning, or that begins at or after 8:00 PM on Sunday and ends on Monday morning may be paid at the shift differential rate.
- Shifts shall receive an additional \$2.50 per hour.

OVERTIME:

- Hours in excess of 8 per day, Monday through Friday, or outside of the regular workday that are not shift work, and all hours on Saturdays, shall be paid at time and one-half the hourly rate. All hours on Sundays and holidays shall be paid at double the hourly rate.
- Four 10-hour days may be worked, Monday through Thursday, at straight time, with Friday used as a make-up day for a day lost to inclement weather. If Friday is not a make-up day, all hours on Friday shall be paid at time and one-half the hourly rate.

RECOGNIZED HOLIDAYS: New Year's Day, Presidents' Day, Memorial Day, July 4th, Labor Day, Presidential Election Day, Veterans' Day, Thanksgiving Day, Christmas Day. Sunday holidays observed the following Monday. Veterans Day may be substituted for the day after Thanksgiving. However, in the trading of Veterans Day for the day after Thanksgiving, if overtime is worked on Veterans Day, it shall be paid at double the hourly rate.

Hazardous Waste Work:

- where Level A, B, or C protection is required: + \$3.00/hr
- other Hazardous Waste site: + \$1.00/hr

Effective Dates:

	06/11/2015		09/01/2015	03/01/2016	09/01/2016	03/01/2017
Rate	Fringe	Total	Total	Total	Total	Total
38.00	26.28	64.28	65.03	66.53	67.63	70.03

CLASSIFICATIONS:

Paving Foreman

Effective Dates:

	06/11/2015		09/01/2015	03/01/2016	09/01/2016	03/01/2017
Rate	Fringe	Total	Total	Total	Total	Total
36.55	26.28	62.83	63.58	65.08	66.18	68.58

CLASSIFICATIONS:

Head Raker

Effective Dates:

	06/11/2015		09/01/2015	03/01/2016	09/01/2016	03/01/2017
Rate	Fringe	Total	Total	Total	Total	Total
36.40	26.28	62.68	63.43	64.93	66.03	68.43

CLASSIFICATIONS:

Raker, Screedman, Luteman

ASPHALT LABORERS - SOUTH **Rates Expiration Date : 08/31/2017**

Effective Dates:

06/11/2015			09/01/2015	03/01/2016	09/01/2016	03/01/2017
Rate	Fringe	Total	Total	Total	Total	Total
36.15	26.28	62.43	63.18	64.68	65.78	68.18

CLASSIFICATIONS:

Tampers, Smoothers, Kettlemen,
Painters, Shovelers, Roller Boys

Effective Dates:

06/11/2015			09/01/2015	03/01/2016	09/01/2016	03/01/2017
Rate	Fringe	Total	Total	Total	Total	Total
36.25	26.28	62.53	63.28	64.78	65.88	68.28

CLASSIFICATIONS:

Milling Controller

Effective Dates:

06/11/2015			09/01/2015	03/01/2016	09/01/2016	03/01/2017
Rate	Fringe	Total	Total	Total	Total	Total
36.45	26.28	62.73	63.48	64.98	66.08	68.48

CLASSIFICATIONS:

Traffic Control Coordinator

TEST BORING PRELIMINARY TO CONSTRUCTION-NORTH **Rates Expiration Date : 10/16/2015**

THESE RATES APPLY IN THE FOLLOWING COUNTIES ONLY:
Bergen, Essex, Hudson, Middlesex, Morris, Passaic, Somerset, Union

SHIFT DIFFERENTIAL:

Employees on a shift other than between the hours of 8:00 AM and 5:00 PM shall receive an additional \$1.00 per hour.

OVERTIME:

Hours in excess of 8 per day, Monday through Friday, and all hours on Saturday shall be paid at time and one-half the regular rate. All hours on Sundays and holidays shall be paid at double the regular rate.

RECOGNIZED HOLIDAYS: New Year's Day, Memorial Day, July 4th, Labor Day, Thanksgiving Day, and Christmas Day. Sunday holidays observed the following Monday.

Hazardous Waste Pay (for Levels A, B, and C): an additional 10% of the hourly rate, per hour.

A newly hired Helper with no experience in the industry shall be paid as follows:

- 1st year on the job - 70% of Helper wage rate
- 2nd year on the job - 80% of Helper wage rate
- 3rd year on the job - 90% of Helper wage rate
- All helpers receive full fringe benefit rate.

Effective Dates:

11/13/2014

Rate	Fringe	Total
29.44	22.89	52.33

CLASSIFICATIONS:

Helper (4th year helper)

Effective Dates:

11/13/2014

Rate	Fringe	Total
36.82	22.89	59.71

CLASSIFICATIONS:

Driller

Effective Dates:

11/13/2014

Rate	Fringe	Total
42.22	22.89	65.11

CLASSIFICATIONS:

Foreman

HEAVY & GENERAL LABORERS - NORTH **Rates Expiration Date : 08/31/2017**

THESE RATES APPLY IN THE FOLLOWING COUNTIES ONLY:

Bergen, Essex, Hudson, Hunterdon, Middlesex, Monmouth, Morris, Passaic, Somerset, Sussex, Union, Warren

{For apprentice rates refer to "Laborer - Heavy & General" apprentice rates in any county rate package}

The regular workday consists of 8 hours, starting at 7:00 AM or 8:00 AM.

SHIFT DIFFERENTIALS:

- Shifts must start at 3:00 PM, 4:00 PM, 12:00 AM, or 1:00 AM, to be considered shift work, except when the project owner mandates special hours of work in the job specifications, in which case those hours may be considered shift work.
- When such hours are mandated by the project owner, a shift that begins before midnight on Friday and ends on Saturday morning, or that begins at or after 8:00 PM on Sunday and ends on Monday morning may be paid at the shift differential rate.
- Shifts shall receive an additional \$2.50 per hour.

OVERTIME:

- Hours in excess of 8 per day, Monday through Friday, or outside of the regular workday that are not shift work, and all hours on Saturdays, shall be paid at time and one-half the hourly rate. All hours on Sundays and holidays shall be paid at double the hourly rate.
- Four 10-hour days may be worked, Monday through Thursday, at straight time, with Friday used as a make-up day for a day lost to inclement weather. If Friday is not a make-up day, all hours on Friday shall be paid at time and one-half the hourly rate.

RECOGNIZED HOLIDAYS: New Year's Day, Presidents' Day, Memorial Day, July 4th, Labor Day, Presidential Election Day, Veterans' Day, Thanksgiving Day, Christmas Day. Sunday holidays observed the following Monday. Veterans Day may be substituted for the day after Thanksgiving. However, in the trading of Veterans Day for the day after Thanksgiving, if overtime is worked on Veterans Day, it shall be paid at double the hourly rate.

Hazardous Waste Work:

- where Level A, B, or C protection is required: + \$3.00/hr
- other Hazardous Waste site: + \$1.00/hr

Effective Dates:

	06/05/2015		09/01/2015	03/01/2016	09/01/2016	03/01/2017
Rate	Fringe	Total	Total	Total	Total	Total
35.75	26.28	62.03	62.78	64.28	65.38	67.78

CLASSIFICATIONS:

"D" Rate:

basic, landscape, asphalt, slurry seal, or railroad track laborer; utility meter installer; traffic director/flagman; salamander tender; pitman; dumpman; rakers or tampers on cold patch work; wrappers or coaters of pipe; waterproofer; timberman; wagon drill or drill master helper; powder carrier; magazine tender; signal man; power buggy operator; tree cutter; operator of basic power tools

Effective Dates:

	06/05/2015		09/01/2015	03/01/2016	09/01/2016	03/01/2017
Rate	Fringe	Total	Total	Total	Total	Total
36.45	26.28	62.73	63.48	64.98	66.08	68.48

CLASSIFICATIONS:

"C" Rate:

pipe layer; laser man; conduit or duct line layer; operator of jack hammer, chipping hammer, pavement breaker, concrete cutter, asphalt cutter, sheet hammer, or walk-behind saw cutter; sandblaster; acetylene cutting or burning; wagon drill, directional drill, or hydraulic drill operator; drill master; core driller; traffic control coordinator; asphalt raker or lute man

HEAVY & GENERAL LABORERS - NORTH **Rates Expiration Date : 08/31/2017**

Effective Dates:

06/05/2015			09/01/2015	03/01/2016	09/01/2016	03/01/2017
Rate	Fringe	Total	Total	Total	Total	Total
36.70	26.28	62.98	63.73	65.23	66.33	68.73

CLASSIFICATIONS:

"B" Rate:

concrete finisher; setter of brick or stone pavers; stone cutter; form setter; manhole, catch basin, or inlet builder; asphalt screedman; rammer; hardscaping; gunite nozzle man

Effective Dates:

06/05/2015			09/01/2015	03/01/2016	09/01/2016	03/01/2017
Rate	Fringe	Total	Total	Total	Total	Total
40.25	26.28	66.53	67.28	68.78	69.88	72.28

CLASSIFICATIONS:

"A" Rate:

blaster

Effective Dates:

06/05/2015			09/01/2015	03/01/2016	09/01/2016	03/01/2017
Rate	Fringe	Total	Total	Total	Total	Total
38.00	26.28	64.28	65.03	66.53	67.63	70.03

CLASSIFICATIONS:

"FOREMAN" Rate:

labor foreman, asphalt foreman, drill foreman, pipe foreman, grade foreman, finisher foreman, concrete foreman

Effective Dates:

06/05/2015			09/01/2015	03/01/2016	09/01/2016	03/01/2017
Rate	Fringe	Total	Total	Total	Total	Total
39.00	26.28	65.28	66.03	67.53	68.63	71.03

CLASSIFICATIONS:

"GENERAL FOREMAN" Rate

HEAVY & GENERAL LABORERS - SOUTH **Rates Expiration Date : 08/31/2017**

THESE RATES APPLY IN THE FOLLOWING COUNTIES ONLY:

Atlantic, Burlington, Camden, Cape May, Cumberland, Gloucester, Mercer, Ocean, Salem

{For apprentice rates refer to "Laborer - Heavy & General" apprentice rates in any county rate package}

The regular workday consists of 8 hours, starting at 7:00 AM or 8:00 AM.

SHIFT DIFFERENTIALS:

- Shifts must start at 3:00 PM, 4:00 PM, 12:00 AM, or 1:00 AM, to be considered shift work, except when the project owner mandates special hours of work in the job specifications, in which case those hours may be considered shift work.
- When such hours are mandated by the project owner, a shift that begins before midnight on Friday and ends on Saturday morning, or that begins at or after 8:00 PM on Sunday and ends on Monday morning may be paid at the shift differential rate.
- Shifts shall receive an additional \$2.50 per hour.

OVERTIME:

- Hours in excess of 8 per day, Monday through Friday, or outside of the regular workday that are not shift work, and all hours on Saturdays, shall be paid at time and one-half the hourly rate. All hours on Sundays and holidays shall be paid at double the hourly rate.
- Four 10-hour days may be worked, Monday through Thursday, at straight time, with Friday used as a make-up day for a day lost to inclement weather. If Friday is not a make-up day, all hours on Friday shall be paid at time and one-half the hourly rate.

RECOGNIZED HOLIDAYS: New Year's Day, Presidents' Day, Memorial Day, July 4th, Labor Day, Presidential Election Day, Veterans' Day, Thanksgiving Day, Christmas Day. Sunday holidays observed the following Monday. Veterans Day may be substituted for the day after Thanksgiving. However, in the trading of Veterans Day for the day after Thanksgiving, if overtime is worked on Veterans Day, it shall be paid at double the hourly rate.

Hazardous Waste Work:

- where Level A, B, or C protection is required: + \$3.00/hr
- other Hazardous Waste site: + \$1.00/hr

Effective Dates:

	06/11/2015		09/01/2015	03/01/2016	09/01/2016	03/01/2017
Rate	Fringe	Total	Total	Total	Total	Total
35.75	26.28	62.03	62.78	64.28	65.38	67.78

CLASSIFICATIONS:

basic, landscape, or railroad track laborer; utility meter installer; traffic director/flagman; salamander tender; pitman; dumpman; rakers or tampers on cold patch work; wrappers or coaters of pipe; waterproofers

tree cutter, timberman

Effective Dates:

	06/11/2015		09/01/2015	03/01/2016	09/01/2016	03/01/2017
Rate	Fringe	Total	Total	Total	Total	Total
35.75	26.28	62.03	62.78	64.98	66.08	68.48

CLASSIFICATIONS:

wagon drill or drill master helper; powder carrier; magazine tender; signal man

HEAVY & GENERAL LABORERS - SOUTH **Rates Expiration Date : 08/31/2017**

Effective Dates:

06/11/2015			09/01/2015	03/01/2016	09/01/2016	03/01/2017
Rate	Fringe	Total	Total	Total	Total	Total
36.45	26.28	62.73	63.48	64.98	66.08	68.48

CLASSIFICATIONS:

pipe layer; laser man; conduit or duct line layer; operator of jack hammer, chipping hammer, pavement breaker, concrete cutter, asphalt cutter, sheet hammer, or walk-behind saw cutter; sandblaster; acetylene cutting or burning

Effective Dates:

06/11/2015			09/01/2015	03/01/2016	09/01/2016	03/01/2017
Rate	Fringe	Total	Total	Total	Total	Total
36.45	26.28	62.73	63.48	64.98	66.08	68.48

CLASSIFICATIONS:

wagon or directional drill operator; drill master

Effective Dates:

06/11/2015			09/01/2015	03/01/2016	09/01/2016	03/01/2017
Rate	Fringe	Total	Total	Total	Total	Total
40.25	26.28	66.53	67.28	68.78	69.88	72.28

CLASSIFICATIONS:

blaster

Effective Dates:

06/11/2015			09/01/2015	03/01/2016	09/01/2016	03/01/2017
Rate	Fringe	Total	Total	Total	Total	Total
38.00	26.28	64.28	65.03	66.53	67.63	70.03

CLASSIFICATIONS:

labor foreman, drill foreman, pipe foreman, grade foreman, finisher foreman, concrete foreman

Effective Dates:

06/11/2015			09/01/2015	03/01/2016	09/01/2016	03/01/2017
Rate	Fringe	Total	Total	Total	Total	Total
39.00	26.28	65.28	66.03	67.53	68.63	71.03

CLASSIFICATIONS:

general foreman

TERRITORY
ENTIRE STATE

NEW JERSEY DEPARTMENT OF LABOR AND WORKFORCE DEVELOPMENT
PREVAILING WAGE RATE DETERMINATION

HEAVY & GENERAL LABORERS - SOUTH **Rates Expiration Date : 08/31/2017**

Effective Dates:

06/11/2015			09/01/2015	03/01/2016	09/01/2016	03/01/2017
Rate	Fringe	Total	Total	Total	Total	Total
36.70	26.28	62.98	63.73	65.23	66.33	68.73

CLASSIFICATIONS:

concrete finisher; setter of brick or stone pavers; stone cutter; form setter; manhole, catch basin, or inlet builder; rammer; gunite nozzle man

PIPELINE - MAINLINE TRANSMISSION Rates Expiration Date : 05/31/2016

These rates apply to the following: welding on Transportation Mainline pipe lines (cross-country pipe lines, or any segments thereof, transporting coal, gas, oil, water or other transportable materials, vapors or liquids, including portions of such pipe lines within private property boundaries up to the final metering station or connection - the point where a valve, consumer connection, or town border station divides mainline transmission lines or higher pressure lateral and branch lines from lower pressure distribution systems).

PER DIEM PAYMENT:

In addition to the total wage rate paid for each craft, the following per diem (per day) amounts must also be paid - Pipeline Journeyman: \$42.50; Pipeline Journeyman Welder: \$102.50; and Pipeline Helper: \$42.50. Note: in order to receive the per diem payment an employee must work a minimum of 8 hours in a 24 hour period.

NOTES:

- Journeymen employed as "stringer bead" welders and journeymen who are regularly employed as "hot-pass" welders shall receive \$1.00 per hour more than other journeymen.
- Welders running "stringer bead" or "hot-pass" on "cutouts" or "tie-ins" on a production basis shall be paid \$1.00 per hour above the journeymen rate.
- Whenever a welder helper is employed using a power buffer or power grinder immediately behind the stringer bead and/or hot-pass welders, and the pipe gang is set on a production basis, the helper shall be paid \$2.00 per hour above the helper rate.
- If back welding is performed inside a pipe under either or both of the following conditions, the welder engaged in the welding will receive \$3.00 per hour above the regular rate for the job only for the days on which such back welding is performed:
 - The employer elects, as a regular procedure, to back weld each line-up. This condition is not intended to apply to occasional back welding performed by the pipe gang to repair a bead, to rectify a "high-lo" condition or wall thickness, etc.
 - A welder is required to back weld a completed weld behind the firing line.
- If the welder helper is required to go inside the pipe for the purpose of brushing, buffing and grinding the weld, they shall receive a wage rate \$1.00 per hour above the regular helper rate for the days involved.
- Welders working on "hot work" shall be paid \$2.00 per hour above the regular rate for each day engaged in such work. "Hot work" is defined as work on lines in service where there is the danger of fire or explosion.

The regular workday shall be 8 hours, between 8:00 AM and 4:30 PM.

OVERTIME:

Hours in excess of 8 per day, and all hours on Sundays shall be paid at time and one-half the regular rate, inclusive of benefits. All hours on holidays shall be paid at double the regular rate, inclusive of benefits.

RECOGNIZED HOLIDAYS: New Year's Day, July 4th, Labor Day, Thanksgiving Day, and Christmas Day. Sunday holidays observed the following Monday.

Effective Dates:

06/02/2015

Rate	Fringe	Total
52.53	26.14	78.67

CLASSIFICATIONS:

Pipeline Journeyman Welder

TERRITORY
ENTIRE STATE

NEW JERSEY DEPARTMENT OF LABOR AND WORKFORCE DEVELOPMENT
PREVAILING WAGE RATE DETERMINATION

PIPELINE - MAINLINE TRANSMISSION Rates Expiration Date : 05/31/2016

Effective Dates:

06/02/2015

Rate	Fringe	Total
52.53	26.14	78.67

CLASSIFICATIONS:

Pipeline Journeyman

Effective Dates:

06/02/2015

Rate	Fringe	Total
31.82	18.28	50.10

CLASSIFICATIONS:

Pipeline Helper

PIPELINE - GAS DISTRIBUTION **Rates Expiration Date : 10/31/2015**

These rates apply to the following: welding on gas line distribution systems (that portion of the gas distribution system placed in streets, roads, subways, tunnels, viaducts, highways and easements which serves the users of gas).

SHIFT DIFFERENTIALS:

An "irregular" shift may start any time from 5:00 PM to 12:00 AM, Monday through Friday, and shall receive an additional 15% of the regular rate per hour, inclusive of benefits.

OVERTIME:

Hours in excess of forty per week, and all hours on Saturdays shall be paid at time and one-half the regular rate, inclusive of benefits. All hours on Sundays and holidays shall be paid at double the regular rate, inclusive of benefits.

RECOGNIZED HOLIDAYS: New Year's Day, Memorial Day, July 4th, Labor Day, Thanksgiving Day, and Christmas Day. Sunday holidays observed the following Monday.

Effective Dates:

10/30/2014

Rate	Fringe	Total
54.13	20.90	75.03

CLASSIFICATIONS:

Pipeline Journeyman Welder

Effective Dates:

10/30/2014

Rate	Fringe	Total
54.13	20.90	75.03

CLASSIFICATIONS:

Pipeline Journeyman

Effective Dates:

10/30/2014

Rate	Fringe	Total
35.07	15.09	50.16

CLASSIFICATIONS:

Pipeline Helper

ASPHALT LABORERS- NORTH **Rates Expiration Date : 08/31/2017**

THESE RATES APPLY IN THE FOLLOWING COUNTIES ONLY:

Bergen, Essex, Hudson, Hunterdon, Middlesex, Monmouth, Morris, Passaic, Somerset, Sussex, Union, Warren

{For apprentice rates refer to "Laborer - Heavy & General" apprentice rates in any county rate package}

The regular workday consists of 8 hours, starting at 7:00 AM or 8:00 AM.

SHIFT DIFFERENTIALS:

- Shifts must start at 3:00 PM, 4:00 PM, 12:00 AM, or 1:00 AM, to be considered shift work, except when the project owner mandates special hours of work in the job specifications, in which case those hours may be considered shift work.
- When such hours are mandated by the project owner, a shift that begins before midnight on Friday and ends on Saturday morning, or that begins at or after 8:00 PM on Sunday and ends on Monday morning may be paid at the shift differential rate.
- Shifts shall receive an additional \$2.50 per hour.

OVERTIME:

- Hours in excess of 8 per day, Monday through Friday, or outside of the regular workday that are not shift work, and all hours on Saturdays, shall be paid at time and one-half the hourly rate. All hours on Sundays and holidays shall be paid at double the hourly rate.
- Four 10-hour days may be worked, Monday through Thursday, at straight time, with Friday used as a make-up day for a day lost to inclement weather. If Friday is not a make-up day, all hours on Friday shall be paid at time and one-half the hourly rate.

RECOGNIZED HOLIDAYS: New Year's Day, Presidents' Day, Memorial Day, July 4th, Labor Day, Presidential Election Day, Veterans' Day, Thanksgiving Day, Christmas Day. Sunday holidays observed the following Monday. Veterans Day may be substituted for the day after Thanksgiving. However, in the trading of Veterans Day for the day after Thanksgiving, if overtime is worked on Veterans Day, it shall be paid at double the hourly rate.

Hazardous Waste Work:

- where Level A, B, or C protection is required: + \$3.00/hr
- other Hazardous Waste site: + \$1.00/hr

Effective Dates:

	06/05/2015		09/01/2015	03/01/2016	09/01/2016	03/01/2017
Rate	Fringe	Total	Total	Total	Total	Total
38.00	26.28	64.28	65.03	66.53	67.63	70.03

CLASSIFICATIONS:

Asphalt Foreman

Effective Dates:

	06/05/2015		09/01/2015	03/01/2016	09/01/2016	03/01/2017
Rate	Fringe	Total	Total	Total	Total	Total
36.70	26.28	62.98	63.73	65.23	66.33	68.73

CLASSIFICATIONS:

Asphalt Screedman

Effective Dates:

	06/05/2015		09/01/2015	03/01/2016	09/01/2016	03/01/2017
Rate	Fringe	Total	Total	Total	Total	Total
36.45	26.28	62.73	63.48	64.98	66.08	68.48

CLASSIFICATIONS:

Asphalt Raker or Lute Man

TERRITORY
ENTIRE STATE

NEW JERSEY DEPARTMENT OF LABOR AND WORKFORCE DEVELOPMENT
PREVAILING WAGE RATE DETERMINATION

ASPHALT LABORERS- NORTH Rates Expiration Date : 08/31/2017

Effective Dates:

06/05/2015			09/01/2015	03/01/2016	09/01/2016	03/01/2017
Rate	Fringe	Total	Total	Total	Total	Total
35.75	26.28	62.03	62.78	64.28	65.38	67.78

CLASSIFICATIONS:

Asphalt Laborer

ELECTRICIAN- UTILITY WORK (NORTH) **Rates Expiration Date : 12/03/2017**

Electrician-Utility Work (North)

(For apprentice rates refer to Electrician-Utility Work (North) in any county rate package).

These rates apply to work contracted for by the following utility companies:

Public Service Electric & Gas Co. of NJ, GPU Energy, Borough of Madison Electric Department, Sussex Rural Electric Cooperative, Rockland Utilities, and Butler Municipal Electric Co.

These rates do not apply to work on substations or switching stations.

For Utility work contracted for by a utility company other than those listed above or those listed under "Electrician-Utility Work (South), see the "Outside Commercial Rates" for the county in which the jobsite is located.

* FOR OUTSIDE COMMERCIAL RATES PLEASE SEE COUNTY RATES

The regular workday is 8 hours, between 6:00 AM and 6:00 PM.

FOR EMERGENCY WORK ONLY: (emergency work is defined as work caused by storm, catastrophe, act of god, and circumstances beyond the control of the employer)-all hours of work shall be paid at double the hourly rate.

SHIFT DIFFERENTIALS:

Shift work must run for a minimum of 5 consecutive workdays.

2nd shift (between the hours of 4:30 PM and 1:00 AM): 8 hours of work + 17.3% of the regular rate, inclusive of benefits.

3rd shift (between the hours of 12:30 AM and 9:00 AM): 8 hours of work + 31.4% of the regular rate per hour, inclusive of benefits.

OVERTIME:

Hours in excess of 8 per day, or before or after the regular workday Monday through Friday, that is not shift work, and all hours on Saturday shall be paid at time and one-half the regular rate, inclusive of benefits. All hours on Sundays and holidays shall be paid at double the hourly rate, inclusive of benefits.

Four 10-hour days may worked, at straight time, between 7:00 AM and 6:30 PM, Monday through Thursday.

RECOGNIZED HOLIDAYS:

New Year's Day, Presidents' Day, Memorial Day, July 4th, Labor Day, Presidential Election Day, Veterans' Day, Thanksgiving Day and Christmas Day, or day on which they are legally observed.

Effective Dates:

	12/01/2014		11/29/2015	12/04/2016
Rate	Fringe	Total	Total	Total
48.93	32.78	81.71	84.36	87.27

CLASSIFICATIONS:

Chief Lineman

Effective Dates:

	12/01/2014		11/29/2015	12/04/2016
Rate	Fringe	Total	Total	Total
46.16	30.92	77.08	79.59	82.34

CLASSIFICATIONS:

Journeyman Lineman

ELECTRICIAN- UTILITY WORK (NORTH) **Rates Expiration Date : 12/03/2017**

Effective Dates:

12/01/2014			11/29/2015	12/04/2016
Rate	Fringe	Total	Total	Total
46.16	30.92	77.08	79.59	82.34

CLASSIFICATIONS:

Special License Operator

Effective Dates:

12/01/2014			11/29/2015	12/04/2016
Rate	Fringe	Total	Total	Total
45.70	30.61	76.31	78.79	81.51

CLASSIFICATIONS:

Transit Man

Effective Dates:

12/01/2014			11/29/2015	12/04/2016
Rate	Fringe	Total	Total	Total
44.32	29.69	74.01	76.40	79.04

CLASSIFICATIONS:

Line Equipment Operator

Effective Dates:

12/01/2014			11/29/2015	12/04/2016
Rate	Fringe	Total	Total	Total
38.78	25.98	64.76	66.85	69.17

CLASSIFICATIONS:

Dynamite Man

Effective Dates:

12/01/2014			11/29/2015	12/04/2016
Rate	Fringe	Total	Total	Total
54.47	36.49	90.96	93.92	97.16

CLASSIFICATIONS:

General Foreman

Effective Dates:

12/01/2014			11/29/2015	12/04/2016
Rate	Fringe	Total	Total	Total
53.09	35.57	88.66	91.53	94.68

CLASSIFICATIONS:

Assistant General Foreman

ELECTRICIAN- UTILITY WORK (NORTH) **Rates Expiration Date : 12/03/2017**

Effective Dates:

12/01/2014			11/29/2015	12/04/2016
Rate	Fringe	Total	Total	Total
51.70	34.63	86.33	89.14	92.21

CLASSIFICATIONS:

Line Foreman

Effective Dates:

12/01/2014			11/29/2015	12/04/2016
Rate	Fringe	Total	Total	Total
37.39	25.05	62.44	64.46	66.69

CLASSIFICATIONS:

Straight Light Mechanical Leader

Effective Dates:

12/01/2014			11/29/2015	12/04/2016
Rate	Fringe	Total	Total	Total
35.54	23.81	59.35	61.28	63.40

CLASSIFICATIONS:

Groundman Winch Operator

Effective Dates:

12/01/2014			11/29/2015	12/04/2016
Rate	Fringe	Total	Total	Total
35.54	23.81	59.35	61.28	63.40

CLASSIFICATIONS:

Groundman Truck Operator

Effective Dates:

12/01/2014			11/29/2015	12/04/2016
Rate	Fringe	Total	Total	Total
35.08	23.50	58.58	60.48	62.57

CLASSIFICATIONS:

Straight Light Mechanic

Effective Dates:

12/01/2014			11/29/2015	12/04/2016
Rate	Fringe	Total	Total	Total
35.08	23.50	58.58	60.48	62.57

CLASSIFICATIONS:

Line Equipment Mechanic

ELECTRICIAN- UTILITY WORK (NORTH) **Rates Expiration Date : 12/03/2017**

Effective Dates:

12/01/2014			11/29/2015	12/04/2016
Rate	Fringe	Total	Total	Total
30.01	20.10	50.11	51.73	53.52

CLASSIFICATIONS:

Groundman 2nd Year

Effective Dates:

12/01/2014			11/29/2015	12/04/2016
Rate	Fringe	Total	Total	Total
27.70	18.55	46.25	47.76	49.39

CLASSIFICATIONS:

Groundman 1st Year

Effective Dates:

12/01/2014			11/29/2015	12/04/2016
Rate	Fringe	Total	Total	Total
45.70	30.61	76.31	78.79	81.51

CLASSIFICATIONS:

Line Equipment Foreman

ELECTRICIAN- UTILITY WORK (SOUTH) Rates Expiration Date : 11/30/2015

Electrician-Utility Work (South)

(For apprentice rates refer to Electrician-Utility Work (South) in any county rate package).

These rates apply to work contracted for by the following utility company:

Atlantic City Electric.

These rates do not apply to work on substations or switching stations.

For utility work contracted for by a utility company other than the one listed above or those listed under "Electrician-Utility Work (North), see the "Outside Commercial Rates" for the county in which the jobsite is located.

* FOR OUTSIDE COMMERCIAL RATES PLEASE SEE COUNTY RATES

The regular workday is 8 hours, between 7:00 AM and 4:30 PM.

FOR EMERGENCY WORK ONLY: (emergency work is defined as work caused by storm, catastrophe, act of god, and circumstances beyond the control of the employer)- all hours of work shall be paid at double the hourly rate.

SHIFT DIFFERENTIALS:

Shift work must run for a minimum of 5 consecutive workdays.

When two (2) or three (3) shifts are worked the following shall apply:

1st shift (between the hours of 8:00 AM and 4:30 PM)

2nd shift (between the hours of 4:30 PM and 12:30 AM): 8 hours of work + 10% of the regular rate of pay for 7.5 hours worked.

3rd shift (between the hours of 12:30 AM and 8:00 AM): 8 hours of work + 15% of the regular rate of pay for 7 hours worked.

OVERTIME:

Hours in excess of 8 per day, or before or after the regular workday Monday through Friday, that is not shift work, and all hours on Saturday shall be paid at time and one-half the regular rate. All hours on Sundays and Holidays shall be paid double the hourly rate.

Four 10-hour days may be worked, at straight time, between 6:00 AM and 6:00 PM, Monday through Thursday with Friday used as a make-up day.

RECOGNIZED HOLIDAYS:

New Year's Day, Memorial Day, July 4th, Labor Day, Veterans' Day, Thanksgiving Day and Christmas Day or on days celebrated.

WORKING RULES:

There shall be a Foreman in charge of each work crew. No crews are to exceed twelve (12) men, including Foremen.

There shall be a General Foreman designated for transmission work when three (3) or more crews are on the same job and for distribution work where there are more than twenty (20) employees on site.

A small job crew shall consist of five (5) or less employees, one (1) of the Journeyman Linemen in the crew shall be designated as a Small Job Foreman.

Work performed from ladders and/or mechanical lift equipment shall be the work of Linemen and/or Apprentices.

On new construction, fitting and framing poles, towers or structures may be done by Journeymen and/or Apprentices. Groundmen may assist, but may not perform any work which would be performed by Linemen if assembled in the air.

There shall be a Journeyman Lineman in each pole setting, erection, grounding, wire and cable-pulling crew of more than three (3) men.

Effective Dates:

12/04/2014

Rate	Fringe	Total
56.05	41.02	97.07

CLASSIFICATIONS:

General Foreman

ELECTRICIAN- UTILITY WORK (SOUTH) Rates Expiration Date : 11/30/2015

Effective Dates:

12/04/2014

Rate	Fringe	Total
49.92	37.54	87.46

CLASSIFICATIONS:

Foreman

Effective Dates:

12/04/2014

Rate	Fringe	Total
47.29	36.06	83.35

CLASSIFICATIONS:

Small Job Foreman

Effective Dates:

12/04/2014

Rate	Fringe	Total
43.79	34.05	77.84

CLASSIFICATIONS:

Heavy Equipment Operator

Effective Dates:

12/04/2014

Rate	Fringe	Total
43.79	34.05	77.84

CLASSIFICATIONS:

Cable Splicer

Effective Dates:

12/04/2014

Rate	Fringe	Total
43.79	34.05	77.84

CLASSIFICATIONS:

Journeyman Lineman

Effective Dates:

12/04/2014

Rate	Fringe	Total
43.79	34.05	77.84

CLASSIFICATIONS:

Journeyman Welder

ELECTRICIAN- UTILITY WORK (SOUTH) **Rates Expiration Date : 11/30/2015**

Effective Dates:

12/04/2014

Rate	Fringe	Total
43.79	34.05	77.84

CLASSIFICATIONS:

Journeyman Painter

Effective Dates:

12/04/2014

Rate	Fringe	Total
35.03	29.07	64.10

CLASSIFICATIONS:

Light Equipment Operator

Effective Dates:

12/04/2014

Rate	Fringe	Total
30.65	26.57	57.22

CLASSIFICATIONS:

Groundman Truck Driver

Effective Dates:

12/04/2014

Rate	Fringe	Total
28.46	25.33	53.79

CLASSIFICATIONS:

Groundman 3rd Year

Effective Dates:

12/04/2014

Rate	Fringe	Total
26.27	24.08	50.35

CLASSIFICATIONS:

Groundman 2nd Year

Effective Dates:

12/04/2014

Rate	Fringe	Total
24.08	22.84	46.92

CLASSIFICATIONS:

Groundman 1st Year

TERRITORY
ENTIRE STATE

NEW JERSEY DEPARTMENT OF LABOR AND WORKFORCE DEVELOPMENT
PREVAILING WAGE RATE DETERMINATION

ELECTRICIAN- UTILITY WORK (SOUTH) Rates Expiration Date : 11/30/2015

Effective Dates:

12/04/2014

Rate	Fringe	Total
19.27	20.09	39.36

CLASSIFICATIONS:

Flagman

HEAVY & GENERAL LABORERS- NEW TRANS HUDSON TUNNELS Rates Expiration Date : 08/31/2017

THESE RATES APPLY TO CONSTRUCTION ON NEW TRANS HUDSON TUNNELS ONLY

{For apprentice rates refer to "Laborer - Heavy & General" apprentice rates in any county rate package}

The regular workday consists of 8 hours, starting at 7:00 AM or 8:00 AM.

SHIFT DIFFERENTIALS:

- Shifts must start at 3:00 PM, 4:00 PM, 12:00 AM, or 1:00 AM, to be considered shift work, except when the project owner mandates special hours of work in the job specifications, in which case those hours may be considered shift work.
- When such hours are mandated by the project owner, a shift that begins before midnight on Friday and ends on Saturday morning, or that begins at or after 8:00 PM on Sunday and ends on Monday morning may be paid at the shift differential rate.
- Shifts shall receive an additional \$2.50 per hour.

OVERTIME:

- Hours in excess of 8 per day, Monday through Friday, or outside of the regular workday that are not shift work, and all hours on Saturdays, shall be paid at time and one-half the hourly rate. All hours on Sundays and holidays shall be paid at double the hourly rate.
- Four 10-hour days may be worked, Monday through Thursday, at straight time, with Friday used as a make-up day for a day lost to inclement weather. If Friday is not a make-up day, all hours on Friday shall be paid at time and one-half the hourly rate.

RECOGNIZED HOLIDAYS: New Year's Day, Presidents' Day, Memorial Day, July 4th, Labor Day, Presidential Election Day, Veterans' Day, Thanksgiving Day, Christmas Day. Sunday holidays observed the following Monday. Veterans Day may be substituted for the day after Thanksgiving. However, in the trading of Veterans Day for the day after Thanksgiving, if overtime is worked on Veterans Day, it shall be paid at double the hourly rate.

Hazardous Waste Work:

- where Level A, B, or C protection is required: + \$3.00/hr
- other Hazardous Waste site: + \$1.00/hr

Effective Dates:

	06/11/2015		09/01/2015	03/01/2016	09/01/2016	03/01/2017
Rate	Fringe	Total	Total	Total	Total	Total
57.75	26.28	84.03	85.03	86.78	88.31	91.28

CLASSIFICATIONS:

Walking Boss & Superintendent

Effective Dates:

	06/11/2015		09/01/2015	03/01/2016	09/01/2016	03/01/2017
Rate	Fringe	Total	Total	Total	Total	Total
57.30	26.28	83.58	84.58	86.03	87.86	90.83

CLASSIFICATIONS:

Heading Foreman, Shaft Foreman, Rod Foreman, Electrical Foreman, Rigging Foreman

HEAVY & GENERAL LABORERS- NEW TRANS HUDSON TUNNELS **Rates Expiration Date : 08/31/2017**

Effective Dates:

06/11/2015			09/01/2015	03/01/2016	09/01/2016	03/01/2017
Rate	Fringe	Total	Total	Total	Total	Total
56.55	26.28	82.83	83.83	85.58	87.11	90.08

CLASSIFICATIONS:

Iron Foreman, Caulking Foreman, Form Foreman, Cement Finishing Foreman, Concrete Foreman, Track Foreman, Clean-up Foreman, Grout Foreman

Effective Dates:

06/11/2015			09/01/2015	03/01/2016	09/01/2016	03/01/2017
Rate	Fringe	Total	Total	Total	Total	Total
60.30	26.28	86.58	87.58	89.33	90.86	93.83

CLASSIFICATIONS:

Blaster

Effective Dates:

06/11/2015			09/01/2015	03/01/2016	09/01/2016	03/01/2017
Rate	Fringe	Total	Total	Total	Total	Total
55.73	26.28	82.01	83.01	84.76	86.28	89.26

CLASSIFICATIONS:

Top Labor Foreman

Effective Dates:

06/11/2015			09/01/2015	03/01/2016	09/01/2016	03/01/2017
Rate	Fringe	Total	Total	Total	Total	Total
55.20	26.28	81.48	82.48	84.23	85.76	88.73

CLASSIFICATIONS:

Skilled Men (including Caulker, Powder Carrier, all other skilled men)

Skilled Men (including Miner, Drill Runner, Iron Man, Conveyor Man, Maintenance Man, Safety Miner, Rigger, Block Layer, Cement Finisher, Rod Man)

Effective Dates:

06/11/2015			09/01/2015	03/01/2016	09/01/2016	03/01/2017
Rate	Fringe	Total	Total	Total	Total	Total
54.98	26.28	81.26	82.26	84.01	85.53	88.51

CLASSIFICATIONS:

Semi-Skilled Men (including Bell or Signal Man top or bottom, Form Worker & Mover, Concrete Worker, Shaft Man, Tunnel Laborer, Caulker's Helper, all other semi-skilled)

Semi-Skilled Men (including Miner's Helper, Chuck Tender, Track Man, Nipper, Brake Man, Derail Man, Cable Man, Hose Man, Gravel Man, Form Man)

TERRITORY
ENTIRE STATE

NEW JERSEY DEPARTMENT OF LABOR AND WORKFORCE DEVELOPMENT
PREVAILING WAGE RATE DETERMINATION

HEAVY & GENERAL LABORERS- NEW TRANS HUDSON TUNNELS Rates Expiration Date : 08/31/2017

Effective Dates:

06/11/2015			09/01/2015	03/01/2016	09/01/2016	03/01/2017
Rate	Fringe	Total	Total	Total	Total	Total
54.23	26.28	80.51	81.51	83.26	84.78	87.76

CLASSIFICATIONS:

All others (including Powder Watchman, Change House Attendant, Top Laborer, Job Steward)

TECHNICAL SPECIFICATIONS

CONDITIONS SPECIFIC TO THIS PROJECT

The Galloping Hill Golf Cart Improvement Project primarily consists of the milling and resurfacing of the existing golf cart path. The work shall include milling of the path to an average depth of 2-1/2 inches and resurfacing with Superpave Hot Mix Asphalt 9.5M64 Surface Course (herein referred to as HMA) to the same depth. Cart widening and new cart construction at various locations are identified on Attachment B – Golf Cart Plan. The project also includes the replacement and installation of asphalt curb and channel drains at numerous locations identified on Attachment B- Golf Cart Plan. Locations of asphalt curb and channel drains identified on the plan may be adjusted in the field prior to construction.

Prior to construction, the Contractor will perform a walk through with the Engineer to confirm and verify project pavement limits, location of asphalt curb, and other proposed improvements.

Prior to the start of work, the Contractor shall go over the limits of all work with the Engineer or duly appointed representative.

The time of completion for this project has been set at 60 calendar days from the issuance of the Notice to Proceed.

Certified payroll records shall be produced and submitted on a bi-weekly basis to the County for all personnel involved with this project. The County shall withhold any and all payments until the certified payroll records are received.

SPECIAL PROVISIONS

AUTHORIZATION OF CONTRACT

The Contract is authorized by the provisions of Title 27 of the Revised Statutes of New Jersey and supplements thereto, and Title 23 of the United States Code - Highways.

The Contract is authorized by the provisions of Title 27 of the Revised Statutes of New Jersey and supplements thereto.

SPECIFICATIONS TO BE USED

The 2007 Standard Specifications for Road and Bridge Construction, of the New Jersey Department of Transportation as amended herein will govern the construction of this Project and the execution of the Contract.

General wage determinations issued under Davis-Bacon and related acts, published by US Department of Labor, may be obtained from the Davis-Bacon web site at <http://www.access.gpo.gov/davisbacon/nj.html> under the appropriate county; select the construction type.

Pay the prevailing wage rates determined by the United States Secretary of Labor and the New Jersey Department of Labor. If the prevailing wage rate prescribed for any craft by the United States Secretary of Labor is not the same as the prevailing wage rate prescribed for that craft by the New Jersey Department of Labor, pay the higher rate.

State wage rates may be obtained from the New Jersey Department of Labor & Workforce Development (Telephone: 609-292-2259) or by accessing the Department of Labor & Workforce Development's web site at http://lwd.dol.state.nj.us/labor/wagehour/wagehour_index.html The State wage rates in effect at the time of award are part of this Contract, pursuant to Chapter 150, Laws of 1963 (NJSA 34:11-56.25, et seq.).

If an employee of the Contractor or subcontractor has been paid a rate of wages less than the prevailing wage, the Department may suspend the Work, and declare the Contractor in default.

The following additional project specific Attachments are located at the end of these Special Provisions:

State wage rates may be obtained from the New Jersey Department of Labor & Workforce Development (Telephone: 609-292-2259) or by accessing the Department of Labor & Workforce Development's web site at http://lwd.dol.state.nj.us/labor/wagehour/wagehour_index.html The State wage rates in effect at the time of award are part of this Contract, pursuant to Chapter 150, Laws of 1963 (N.J.S.A. 34:11-56.25 et seq.).

If an employee of the Contractor or subcontractor has been paid a rate of wages less than the prevailing wage, the Department may suspend the Work, and declare the Contractor in default.

The following Wholly State funded project Attachments that are located at the end of these Special Provisions:"

1. State of New Jersey [Equal Employment Opportunity Special Provisions for Construction Contracts](#) Funded by Wholly or partially State Funds.
2. [Payroll Requirements](#) for 100 Percent State Projects.
3. [Americans with Disabilities Act](#) for 100 Percent State Funded Contracts.
4. Small Business Enterprise Utilization Attachment for 100% State Funded Contracts.

The following additional project specific Attachments are located at the end of these Special Provisions:

GENERAL

Prior to the start of construction the contractor must submit a Material Questionnaire (SA-11) listing all sources of materials. Any materials used on the project from a non-approved New Jersey Department of Transportation source will be considered non-participating.

Award of contract and subletting will not be permitted to, materials will not be permitted from, and use of equipment will not be permitted that is owned and/or operated by, firms and individuals included in the report of suspensions, debarments and disqualifications of firms and individuals as maintained by the Department of the Treasury, General Services Administration, CN-039, Trenton NJ 08625 (609-633-3990).

Payment for a pay item in the proposal includes all the compensation that will be made for the work of that item as described in the contract documents unless the "basis of payment" clause provides that certain work essential to that item will be paid for under another pay item.

Whenever any section, subsection, subpart or subheading is amended by such terms as changed to, deleted or added it is construed to mean that it amends that section, subsection, subpart or subheading of the 2007 Standard Specifications unless otherwise noted.

Whenever reference to page number is made, it is construed to refer to the 2007 Standard Specifications, as amended herein, unless otherwise noted.

Henceforth in this supplementary specification whenever reference to the State, Commissioner, Department, Engineer or Inspector is made, it is construed to mean the UNION COUNTY ENGINEER.

Whenever reference to Title 27 is made, it is construed to mean Title 40.

Materials or assemblies as specified will be accepted on the basis of certificates of compliance stating that such materials or assemblies fully comply with the requirements of the contract.

Materials or assemblies used on the basis of certificates of compliance may be sampled and tested at any time and if found not to be in conformity with the contract requirements, will be subject to rejection whether in place or not. The Contractor shall require the manufacturer or supplier to furnish three copies of certificates of compliance with each delivery of materials, components and manufactured items that are acceptable by certification.

Certificates of compliance shall contain the following information:

1. Project and location to which the material is consigned.
2. Name of the Contractor to which the material is supplied.
3. Kind of material supplied.
4. Quantity of material represented by the certificate.
5. Means of identifying the consignment, such as label marking, seal number, etc.
6. Date and method of shipment.
7. Statement that the material has been tested and found in conformity with the pertinent contract requirements stated in the certificate.
8. Signature of a person having legal authority to bind the supplier.
9. Signature attested to by a Notary Public or other properly authorized person.

Payments relative to materials specified, shall be accepted on the basis of certificates of compliance shall not be made until the Engineer has in his possession an acceptable certificate of compliance.

FOREIGN MATERIALS

The attention of the Contractor is directed to all existing federal and state statutes and regulations that prohibit on any public work the use, by the Contractor or subcontractor, of materials produced or manufactured outside the United States of America. Exceptions to this prohibition, upon the findings of the Engineer, are allowed only where its enforcement would be inconsistent with the public interest or where the material is not produced or manufactured in the United States in sufficient quantities and of a sufficient quality.

If the Engineer finds that in the performance of the contract there has been a failure to comply with the provisions relative to foreign materials, he shall make public his findings and no other contract for the construction of any public work by this contracting agent shall be awarded to such Contractor, or to any partnership, association or corporation with which such Contractor is associated or affiliated, within a period of three years after such finding is made public.

Where the use of foreign material is allowed, such material shall be furnished in accordance with the following requirements:

1. Materials manufactured or produced outside the United States shall be delivered to a location, approved by the Engineer, where they shall be retained until examination can be completed.
2. The Contractor shall arrange, at his expense, any testing which the Engineer feel necessary to ascertain the acceptability of the material.
3. A certificate of compliance shall accompany each lot of foreign material. In addition, certified mill tests reports shall be attached to the certificate of compliance for those materials for which mill test reports are required and shall clearly identify the lot to which they apply. Certificates of compliance shall contain the following information:
 - A. Project to which the material is consigned.
 - B. Name of the Contractor to which the material is supplied.
 - C. Kind of material supplied.

- D. Quantity of material represented by the certificate.
- E. Means of identifying the consignment, such as label marking, seal number, etc.
- F. Date and method of shipment.
- G. Statement that the material has been tested and found in conformity with the pertinent contract requirements stated in the certificate.
- H. Signature of a person having legal authority to bind the supplier.
- I. Signature attested to by a notary public or other properly authorized person.

The following Sections of the Standard Specifications are deleted:

SECTION 102 – BIDDING REQUIREMENTS AND CONDITIONS
SECTION 103 – AWARD AND EXECUTION OF CONTRACT

The above Sections of the Standard Specifications are changed to the requirements of the County of Union in General Specifications attached hereto.

The below Sections of the Standard Specifications have been changed to the requirements of the County of Union as stipulated herein, in the event of conflicts between the below sections and those of Union County, Union County stipulations shall govern.

SECTION 104 – SCOPE OF WORK
SECTION 109 – MEASUREMENT AND PAYMENT

DIVISION 100 – GENERAL PROVISIONS

SECTION 101 – GENERAL INFORMATION

101.03 TERMS

THE FOLLOWING TERMS ARE CHANGED.

Completion

(3) IS CHANGED TO:

3. the Contractor has satisfactorily executed and delivered to the RE all documents, required forms, certifications, and proofs of compliance required by the Contract Documents, it being understood that the satisfactory execution and delivery of documents, certificates, and proofs of compliance is a requirement of the Contract.

Department: Shall be defined as the County of Union.

Resident Engineer (RE) shall be defined as a representative of the County of Union or Engineer.

Pavement Structure. The combination of pavement, base courses, and when specified, a subbase course, placed on a subgrade to support the traffic load and distribute it to the roadbed (see Figure 101-1). These various courses are defined as follows:

1. **pavement.** One or more layers of specified material of designed thickness at the top of the pavement structure.
2. **base course.** One or more layers of specified material of designed thickness placed on the subgrade or subbase.
3. **subbase.** One or more layers of specified material of designed thickness placed on the subgrade.

SECTION 104 – SCOPE OF WORK

104.03.03 Types of Changes

3. Changes in the Character of Work.

a. Differing Site Condition.

THE SECOND PARAGRAPH IS CHANGED TO:

The Department will make payment for increased costs resulting from a Type 1 or Type 2 Differing Site Condition as a change in the character of work; however, the Department will not consider making payment for a differing site condition unless the resulting change in cost exceeds \$7,500. Except, if the Contractor incurs cost as the result of multiple differing site conditions, with the cost of each separate differing site condition having a value of at least \$1,500 but not more than \$7,500, the Department will consider making payment for such costs if the aggregate cost of the multiple differing site conditions exceeds \$7,500. If the change in cost exceeds these amounts, the Department will base the modification on the total cost of the change, and the Department will not deduct the threshold amount of \$7,500 from the cost of the change.

104.03.04 Contractual Notice

THE SECOND PARAGRAPH IS CHANGED TO:

Immediately provide written notice to the RE of a circumstance that is believed to be a change to the Contract, include the following in the initial written notice:

1. A statement that this is a notice of a change.
2. The date when the circumstances believed to be a change was discovered.
3. A detailed and specific statement describing the nature and circumstances of the change.
4. If the change will or could affect costs to the Department.
5. If the change will or could affect Contract Time as specified in 108.11.01.C.

In addition to the hard copy of the notice, email the notice to the RE. It is not necessary to attach listed documents to the email.

104.03.08 Force Account

7. Equipment.

a. Contractor-Owned Equipment.

PART 1 IS CHANGED TO:

- 1 The Department will calculate the “rental” hourly rates by dividing the monthly rate by 176. The Department will not use weekly, daily, or hourly rates. The Department will apply rental hourly rates for every hour the equipment is in active use, except that for any 30-day period, the Department will limit the total amount paid for each piece of equipment to a maximum of the monthly rate.

THE FOLLOWING PART IS ADDED:

6. The Department will make payment for costs for transporting equipment to and from the work site, if said costs are solely required as a direct result of the Force Account activity.

THE SECOND PARAGRAPH IS CHANGED TO:

The payment established is full payment for all equipment costs, including the cost of fuel, repairs, maintenance, depreciation, storage and incidentals.

10. Subcontractors.

THE SECOND PARAGRAPH IS CHANGED TO:

The Department will make payment for markup on subcontracted work at the rate of 5 percent applied on the total amount of all costs for subcontracted force account work up to \$500,000 and 2% applied on the total amount of all costs for subcontracted force account work over \$500,000.

104.03.09 Delay Damages

1. Non-Productive Activity.

e. Equipment.

THE FIRST SENTENCE IS CHANGED TO:

If as the result of the delay, equipment cannot be used for any active work, and is directed by the RE to remain on the work site during the delay, the Department will make payment as specified in 104.03.08.7.a.5.

SECTION 105 – CONTROL OF WORK

105.05 WORKING DRAWINGS

THE SECOND PARAGRAPH IS CHANGED TO:

Ensure that working drawing submissions also conform to the Department design manuals and other Department standards for the proposed work. After Award, the Department will provide additional formatting information, the number of copies required, and the address of the receiving designated design unit.

THE THIRD PARAGRAPH IS CHANGED TO:

Submit working drawings on 22 × 36-inch sheets. The Department may approve the use of 8-1/2 x 11 inch sheet on a case by case basis. Submit design calculations required for the working drawings on 8-1/2 × 11-inch paper. Submit 7 copies of the working drawings to the designated design unit for review with a copy of the transmittal letter to the RE. For railroad-carrying structures, submit 4 additional copies to the designated design unit. Submit an additional copy for each outside testing agency or authority involved in the Project.

THE NINTH PARAGRAPH IS CHANGED TO:

Submit working drawings for certification or approval as specified in [Table 105.05-1](#). This list is not all inclusive. Ensure that the working drawings submitted for approval are signed and sealed by a Professional Engineer. The working drawings submitted for certification are not required to be signed and sealed by a Professional Engineer unless they alter the original Contract

TABLE 105.05-1 IS CHANGED TO:

Table 105.05 1 – Working Drawing Submission Category	
Certified	Approved
Breakaway I-Beam GA Sign Support Posts	Catalog Cuts (related to landscape Items)
Bridge Drainage	Change in Structural Steel Details
Bridge Railing and Fencing Anchorage System	Change of Prestressed Concrete Strand Patterns
Catalog Cuts	Demolition Plans
Composite Piles	Erection Plans
DMS Sign Support Structure	High Load Multi-Rotational (HLMR) Bearings
DMS Standard Ground Mounted	Isolation Bearings
Elastomeric Bearings Pads	ITS System Drawings, including Block Diagrams
Electrical Items Not Pre-Qualified	Machinery and Electrical Items for Movable Bridges
Expansion Deck Joint Assembly Systems	Mechanically Stabilized Earth (MSE) Walls
Modular Expansion Joint Assembly	Other work shown on the Plans as conceptual
Precast Prestressed Concrete Beams and Piles Fabrication	Precast Concrete Arch Structures
Reinforced Elastomeric Bearings	Precast Concrete Box Culverts
Sign Legends	Prefabricated Modular Walls
Sign Support Structures	Stay-In-Place Forms
Structural Steel Fabrication	Temporary Sheeting and Cofferdams
	Temporary Shielding

THE FIRST PARAGRAPH UNDER PART 1 OF TENTH PARAGRAPH IS CHANGED TO:

1. **Certified Working Drawings.** For working drawings requiring certification, include 2 blank blocks directly above the title block. Designate one block for design unit certification, and designate the other block for the Contractor's approval stamp and a signed statement stating that the Contract has not been altered. The Department will require 30 days for review and certification or rejection and return of certified working drawings.

1. **Certified Working Drawings.**

THE LAST SENTENCE OF THE FIRST PARAGRAPH IS CHANGED TO:

The Department will require 15 days for review and certification or rejection and return of certified working drawings.

2. **Approved Working Drawings.**

THE LAST SENTENCE OF THE FIRST PARAGRAPH IS CHANGED TO:

The Department will require 15 days for review and approval or rejection and return of working drawings.

105.07 Cooperation with Utilities.

THE FOLLOWING HAS BEEN ADDED

- A. **General.** It is understood and agreed that the Contractor has considered in its Proposal all of the permanent and temporary utility facilities in their present, new, or relocated positions to the extent required by the Contract Documents and as revealed by its own investigations; is aware that utility service demands, adverse field conditions and emergencies may affect the Utility's ability to comply with the proposed schedules for utility work; is cognizant of the limited ability of the County to control the actions of the Utility(s), and has made allowances in its Proposal that it is not entitled to any Additional Compensation by reasons of delays, inconvenience or damage sustained by the Contractor due to any interference from utility facilities or the operation of moving or installing them. Similarly, the Contractor is deemed to understand that only limited extensions of time may be granted as specified in Subsection 108.11.

The Contractor shall notify, in writing, the Utility(s) involved of the nature and scope of the Project, and of its operations that may affect their facilities or property. The notice shall include an inquiry for all information required to determine the location of the existing utility facilities and the Contractor shall also provide the portion of the approved Preliminary Schedule relative to that respective Utility. Two copies of such notices and the Utility's responses shall be sent to the Resident Engineer prior to the start of Construction Operations. The Contractor shall also attend a Utility preconstruction conference prior to the start of Construction Operations.

The Contractor shall provide each Utility the portion of the approved Baseline CPM Schedule related to the respective Utility and any approved updates or revisions that affect that Utility.

Information on the Utility(s), including the work to be performed by the Utility(s) on the Project, will be provided in the Special Provisions.

The corporations, companies, agencies, or municipalities owning or controlling the utilities, and the name, title, address, and telephone number of their local representative are attached herein.

Bidders are advised to verify the above information as its accuracy and completeness is not guaranteed by the County.

The Contractor is advised that the design for this Contract did not identify any anticipated utility conflicts. However, this Contract does require the Contractor to call the State's One Call System as specified in Subpart C., to verify that a conflict does not exist.

A pre-construction meeting will be held to enable full coordination of parties involved in this project. The County will arrange this meeting shortly after award of contract and prior to the start of any work and send an agenda and written invitations to municipal officials, utility owners and any other interested parties.

A minimum of five business days prior to the pre-construction meeting, the Contractor will provide the County, in writing, with the following:

- 1. Proposed work schedule;*
- 2. List of Sub-Contractors;*
- 3. List of material suppliers;*
- 4. Certificates of Compliance for all materials and or assemblies, including: Raised Pavement Markings; Signs; Public Sidewalk Ramp Delineation, etc.;*
- 5. Breakdown of any lump sum items;*
- 6. Shop drawings of all construction items.*

THE CONTRACTOR WILL NOT COMMENCE WORK UNTIL THE ABOVE MATERIAL IS RECEIVED & APPROVED.

105.07.01 Working in the Vicinity of Utilities

C. Protection of Utilities.

THE FOURTH PARAGRAPH IS CHANGED TO:

Access within railroad right-of-way is restricted. Before beginning work within the railroad ROW or on railroad facilities, obtain the railroad's written approval for access, the method of construction, and the schedule of the work. Provide a copy of the submittal and approval to the RE. Comply with the railroad's requirements for working within the railroad right-of-way.

THE FOLLOWING IS ADDED TO THE SIXTH PARAGRAPH

Ensure that the work is performed following the railroad's access and safety restrictions.

SECTION 106 – CONTROL OF MATERIAL

106.07.01 Certification of Compliance

Submit manufacturer's Certifications of Compliance stating that the materials and/or assemblies fully comply with the requirements of the Contract when required by the Contract or requested by the Department.

Ensure that Manufacturer's Certification of Compliance contains the following information:

1. Project Name.
2. Name of the Contractor.
3. Material description.
4. Quantity of material represented by the certification.
5. Means of identifying the consignment, such as label marking or seal number.
6. Date and method of shipment.
7. A statement that the material conforms to the Contract material requirements and that representative samples have been sampled and tested.

8. If the submission is for an assembly of materials, a statement that the assembly conforms to the Contract.
9. Signature of a person having legal authority to bind the supplier.
10. Typed or printed name of the person who signed the certification.

Before incorporating the materials into the Project, obtain 3 copies of the manufacturer's Certifications of Compliance for materials, components, and manufactured items that are accepted by certification. Retain 1 copy and submit 2 copies to the RE. With the Certification of Compliance, provide a transmittal identifying the Item for which it is submitted. For products that contain steel or iron, attach additional documents as required by the certification procedures as specified in 106.07.02. The Contractor may submit the Certifications of Compliance electronically to the RE in a scanned document. Include the transmittal and all backup documentation in the scanned document.

The Department has the right to sample and test materials or assemblies accepted on the basis of Certifications of Compliance at any time. The Department will reject materials or assemblies, whether in place or not, if found not to be in conformance with the Contract requirements.

The Department will not make payment for an Item for which material is accepted on the basis of a Certification of Compliance until the RE has received the required Certification of Compliance and has inspected and accepted the material or assembly.

106.07.02 Certification for iron and steel

- A. Precast Concrete Steel and Concrete Pipe Certification of Compliance.** For precast concrete and concrete pipe items, a Buy America Compliance Plan is required to confirm that the material meets the Buy America requirements as specified in 106.03. The ME will periodically audit compliance with the program at the precast plant. If the precast concrete item is not inspected by ME, submit a Certification of Compliance for the precast concrete item as required in 106.07.01. When a Certification of Compliance is submitted, ensure that the Certification of Compliance contains a statement that the reinforcing steel used in the precast concrete item complies with the Buy America requirements as specified in 106.03
- B. Incidental Steel or Iron Components and Manufactured Products.** Incidental steel and iron components such as lifting hooks, tie wire, chairs, nuts, bolts and screws are not required to be certified for compliance with Buy America requirements. For manufactured products that are not made predominantly of steel, the steel components are not required to be certified for compliance with Buy America requirements.
- C. Step Certification of Compliance.** For products that contain steel or iron components and are not covered in 106.07.02.A or 106.07.02.B, step Certification of Compliance is required to confirm that the item meets the Buy America requirements as specified in 106.03. A step certification is a process under which each handler (e.g., supplier, fabricator, manufacturer, processor, coating facility) of the iron and steel components certifies that the steel and iron components were of domestic origin and that their step in the process was domestically performed.

Every step in the process from melting to coating must be performed in the United States in order for the steel or iron component to be considered domestic and must be documented by step certification. If a domestic source for a steel or iron component cannot be found, submit a request for waiver to the Department. Do not purchase non-domestic steel or iron components without the express written consent of the Department.

Ensure that 3 copies of the Contractor's Certification of Compliance (Form DC-17) and the step Certifications of Compliance are provided for items containing steel or iron. Retain 1 copy and submit 2 copies to the RE. The Contractor may submit the DC-17 and the step certifications electronically in a scanned document.

Ensure that step Certifications of Compliance contain the following information:

1. Name of the Company supplying the material.
2. Name and location of the Company the material was shipped to.
3. Material description.
4. Quantity of material represented by the Certification.
5. Means of identifying the consignment, such as label marking or seal number.
6. Date and method of shipment.
7. A statement that the material conforms to the Contract material requirements and to the Buy

America requirements in 106.03.

8. A statement that all steel or iron components in the material or assembly were “melted and manufactured in the US”, unless there is non-domestic steel or iron in the material or assembly.
9. If there is non-domestic steel or iron in the assembly, describe in detail the non-domestic steel or iron material and the quantity. Attach a copy of the Department’s approval for the use of non-domestic steel or iron components.
10. Signature of a person having legal authority to bind the supplier.
11. Typed or printed name of the person who signed the certification.

The Department will not make payment for work containing steel or iron materials until the RE has received the required DC-17 and step Certifications of Compliance and has inspected and accepted the material or assembly.

SECTION 107 - LEGAL RELATIONS

107.04 NEW JERSEY CONTRACTUAL LIABILITY ACT

THE FOURTH PARAGRAPH IS CHANGED TO:

For purposes of determining the date of “completion of the contract” pursuant to N.J.S.A. 59:13-5, “completion of the contract” occurs on the date that the Contractor provides written notice to the Department of Acceptance or conditional Acceptance of the Proposed Final Certificate or the 30th day after the Department issues the Proposed Final Certificate, whichever event occurs first.

107.09 INDEPENDENT CONTRACTOR

THE ENTIRE SUBSECTION IS CHANGED TO:

The relationship of the Contractor to the State is that of an independent contractor. Conduct business consistent with such status. Do not hold out or claim to be an officer or employee of the Department by reason hereof. Do not make a claim, demand, or application to or for the rights or privileges applicable to an officer or employee of the Department, including, but not limited to, Workers Compensation Insurance, unemployment insurance benefits, social security coverage, or retirement membership or credit.

107. 11 RISKS ASSUMED BY THE CONTRACTOR

THE ENTIRE SUBSECTION IS CHANGED TO:

1. **Risks of Loss or Damage to the Permanent Construction.** Until Acceptance, and within the limits of the Project’s work, the Contractor shall bear the risk of all loss or damage to all permanent construction and temporary construction performed under this Contract and to materials, whether or not it has received payment for such construction or materials under Subsection 109.05, 109.06, or 109.07, except payment will be made to the Contractor for the repair or replacement of any permanent element of the construction which has not been accepted by the Department, if the element of the work damaged is completed to the stage of serving its intended function and is subsequently damaged by accident by public traffic. In order to receive payment, the Contractor must supply satisfactory evidence that such damage was caused by a public traffic accident that was not caused by vandalism or by the equipment of the Contractor or any of its subcontractors or suppliers. Satisfactory evidence shall generally be limited to: accident reports filed with the Division of Motor Vehicles, police agencies or insurance companies; statements by reliable, unbiased eye witnesses; identification of the vehicle involved in the accident. Physical evidence that the damage was caused by a motor vehicle (such as tire marks or broken headlight glass) will not be sufficient unless it can be clearly shown that the damage was not caused by the Contractor’s vehicles or by vandalism. The Contractor shall take every precaution, as allowed by the Contract against injury or damage to any part of the construction or to materials by the action of the elements, the traveling public,

vandalism, or from any other cause, whether arising from the execution or the non-execution of the work. The Contractor shall promptly repair, replace, and make good any such damage or loss without cost to the Department. The Contractor shall not bear such risk of loss or damage, which arises from acts of war or floods, tidal waves, earthquakes, cyclones, tornadoes, hurricanes, or other cataclysmic natural phenomenon unless such loss or damage is covered by insurance.

THE FOLLOWING SUBSECTION IS ADDED:

107.17 COMMUNICATION WITH THE NEWS MEDIA

Do not communicate with the news media or issue a news release without obtaining a prior written approval from the Department.

SECTION 108 – PROSECUTION AND COMPLETION

108.01 SUBCONTRACTING

1. Values and Quantities.

THE FOLLOWING IS ADDED TO FIRST PARAGRAPH

1. There are no Specialty Items in this Project.

THE THIRD PARAGRAPH IS CHANGED TO:

If a partial quantity of work for a unit price Item is subcontracted, the Department will determine the value of the work subcontracted by multiplying the price of the Item by the quantity of units to be performed by the subcontractor.

THE FOURTH PARAGRAPH IS CHANGED TO:

If only a portion of work of an Item is subcontracted, the Department will determine the value of work subcontracted based on the value of the work subcontracted as indicated in the subcontract agreement and as shown in a breakdown of cost submitted by the Contractor.

108.02 COMMENCEMENT OF WORK

THE SUBPART 4 IN THE FIRST PARAGRAPH IS CHANGED TO:

4. Progress schedule as specified in 153.03

108.06 NIGHT OPERATIONS

THE FOLLOWING IS ADDED TO THE BEGINNING OF THE FIRST PARAGRAPH:

The Contractor shall be responsible for furnishing, maintaining, removal & or disposal of all equipment, material & manpower necessary for compliance with this sub-section.

2. Visibility Requirements for Workers and Equipment.

THE FIRST PARAGRAPH IS CHANGED TO:

Ensure that workers wear a 360° high-visibility retroreflective safety garment meeting ANSI/ISEA Class 3, Level 2 standards.

108.07 TRAFFIC CONTROL

THE FOLLOWING IS ADDED:

Working hours for this project are as follows:

Weekdays (Monday through Friday)

Day-Time 9 am to 4 pm

Night-Time 9pm to 6am

Weekends / Holidays

Not Allowed without Approval from Union County

108.09 Maintenance within the Project Limits

The following is added to this sub-section:

The Contractor shall not be responsible for mowing unless an item for mowing is scheduled in the proposal form. However, the Contractor shall be responsible for the removal of all leaves, debris & other material on the path, prior to milling and resurfacing. The Contractor will also be responsible for path sweeping prior to resurfacing operations, and at the end of each day following milling operations.

108.19 COMPLETION AND ACCEPTANCE

THE FOLLOWING IS ADDED:

No Incentive Payment for Early Completion is specified for this project.

SECTION 109 – MEASUREMENT AND PAYMENT

109.01 MEASUREMENT OF QUANTITIES

THE SECOND PARAGRAPH IS DELETED:

109.02 SCOPE OF PAYMENT

THE THIRD SENTENCE OF THE FIRST PARAGRAPH IS CHANGED TO:

The Department will not make additional or separate payment for work or portion of work unless specifically provided for in the “Measurement and Payment” Subsection.

109.05 ESTIMATES

THE SECOND PARAGRAPH IS CHANGED TO:

The RE will provide a summary of the Estimate to the Contractor. Before the issuance of each payment, certify, on forms provided by the Department, that:

- Each subcontractor or supplier has been paid the amount due from the previous progress payment and shall be paid the amount due from the current progress payment and that full payment for any retainage withheld from a subcontractor has been or will be made within 30 days after the subcontractor’s work has been satisfactorily completed; or

- There exists a valid basis under the terms of the subcontractor's or supplier's contract to withhold payment from the subcontractor or supplier, and therefore payment is withheld.

THE TENTH PARAGRAPH IS CHANGED TO:

The RE has the right to not process an Estimate when, in the judgment of the RE, the Work is not performed or proceeding as specified in the Contract or following the Department giving the Contractor and Surety notice of default as specified in 108.14.

DIVISION 150 – CONTRACT REQUIREMENTS

SECTION 152 – INSURANCE

152.03.01 Owner’s and Contractor’s Protective Liability Insurance

A. Policy Requirements.

THE FOURTH SENTENCE OF THE FIRST PARAGRAPH IS CHANGED TO:

Ensure that policies are underwritten by companies with a current A.M. Best rating of A- with a Financial Size Category of VII or better.

SECTION 153 – PROGRESS SCHEDULE

153.03.02 CPM Progress Schedule Updates

THE LAST PARAGRAPH IS CHANGED TO:

If the project falls behind schedule for nonexcusable delays, so that the schedule indicates that the Work will not be completed by the Completion date, as specified in 108.10, take the necessary steps to improve progress. Under such circumstances, the RE may direct the Contractor to increase the number of shifts, begin overtime operations, work extra days including weekends and holidays, and supplement its construction plant. Furthermore, the RE may require the Contractor to submit for approval a recovery schedule showing how the Contractor proposes to meet the directed acceleration.

2. Tabular Reports.

THE FIRST SENTENCE OF THE FIRST PARAGRAPH IS CHANGED TO:

The RE may require 3 color paper copies of the longest path sort, total float sort, responsibility sort, area sort, and Gantt chart.

153.03.03 Bar Chart Progress Schedule and Updates

A. Schedule.

THE THIRD SENTENCE OF THE THIRD PARAGRAPH IS CHANGED TO:

Provide 3 color paper copies of a bar chart progress schedule or similar type that is acceptable to the RE for approval as follows:

THE FOLLOWING IS ADDED:

If the project falls behind schedule for nonexcusable delays, so that the schedule indicates that the Work will not be completed by the Completion date, as specified in 108.10, take the necessary steps to improve progress. Under such circumstances, the RE may direct the Contractor to increase the number of shifts, begin overtime operations, work extra days including weekends and holidays, and supplement its construction plant. Furthermore, the RE may require the Contractor to submit for approval a recovery schedule showing how the Contractor proposes to meet the directed acceleration.

153.04 MEASUREMENT AND PAYMENT

THE THIRD PARAGRAPH IS CHANGED TO:

If the Contractor’s CPM Progress Schedule update is not approved by the date of the progress meeting for the following update, the Department will assess liquidated damages to recover the Department’s increased administrative costs. The Department will assess damages for each delinquent update as follows:

SECTION 157 – CONSTRUCTION LAYOUT AND MONUMENTS

157.03.01 MEASUREMENT AND PAYMENT

THE FOLLOWING IS ADDED:

Payment will not be made for Construction Layout. All cost thereof shall be included within the various bid pay items.

SECTION 160 – PRICE ADJUSTMENTS

160.03.02 Asphalt Price Adjustment

NOTE 1 OF THE THIRD PARAGRAPH IS CHANGED TO:

1. The N. J. Department of Transportation will determine the weight of asphalt binder for price adjustment by multiplying the percentage of new asphalt binder in the approved job mix formula by the weight of the item containing asphalt binder. If a Hot Mix Asphalt item has a payment unit other than ton, the Department will apply an appropriate conversion factor to determine the number of tons used.

THE FOURTH PARAGRAPH IS CHANGED TO:

$$A = B \times [(MA - BA)/BA] \times C \times M \times G$$

Where:

A = Asphalt Price Adjustment

B = Bid Price for Tack Coat/Prime Coat

MA = Monthly Asphalt Price Index

BA = Basic Asphalt Price Index

C = Petroleum Content of the Tack Coat and Prime Coat in Percent by Volume:

Use 100% for cutbacks and Tack Coat 64-22

60% for Polymer Modified Tack Coat

60% for RS or similar type emulsions

M = Percentage of Bid Price Applicable to Materials Only: Use 82%

G = Gallons of Tack Coat and Prime Coat Furnished and Applied

160.04 Measurement and Payment

THE FOLLOWING IS ADDED TO THIS SUB-SECTION:

An Allowance for *Asphalt Price Adjustment* has been established in the bid proposal sheet. The allowance amount is based on the latest NJDOT formulas for estimating price adjustments which will be the basis for future adjustments if warranted.

Asphalt price adjustments will not be made for Tack Coat and Prime Coat.

SECTION 202 – EXCAVATION

202.01 DESCRIPTION

THE FOLLOWING IS ADDED:

Excavation, Unclassified - All work associated with this item shall be in accordance with Section 202.03.03 of the Standard Specifications and herein described. Excavation Unclassified includes the removal and disposal of the material associated with the construction of new paths, the widening of existing paths and the removal of existing paths. The adjacent areas shall be graded to blend with the elevation of the path.

202.03.03 Excavating Unclassified Material

A. Excavating.

THE FIRST PARAGRAPH IS CHANGED TO:

The Department, as the generator, is solely responsible for the designation of excavated material. Unclassified excavation consists of excavation and management of material of whatever nature encountered, except for regulated material, pavement removal and acid producing soil.

202.03.07 Reuse or Disposal of Excess Material

A. Reuse.

THE THIRD PARAGRAPH IS CHANGED TO:

Upon RE's approval, reuse excavated soil to widen or flatten slopes of embankment, to fade embankments into cuts, or as approved at other locations. Ensure that the excess material is not reused within a wetland, a transition area, a riparian zone, a flood hazard area or other regulated area without obtaining an appropriate NJDEP permit.

B. Disposal.

PARTS 1 AND 2 UNDER THE FIRST PARAGRAPH ARE CHANGED TO:

1. At least 10 days before disposing, submit the disposal procedure and location to the RE for approval. Do not dispose of excavation on property proposed to be used for parks, playgrounds, and other recreational purposes; residential facilities, and educational facilities; environmentally sensitive areas such as wetlands, and historic sites; or areas within sight of a State highway during all seasons.
2. Obtain the property owner's notarized authorization of the acceptance of the excess material and where it is being placed.

202.04 MEASUREMENT AND PAYMENT

THE FOLLOWING IS ADDED:

Payment for the item Excavation, Unclassified, will be the quantity as above described, at the price bid per cubic yard bid for the item **EXCAVATION, UNCLASSIFIED** in the Bidding Sheets.

The Excavation, Unclassified item shall include all work necessary construct new paths, widen paths and to remove existing paths, as indicated by the Engineer.

The removal and disposal of existing curbs will not be measured. Payment for such work will be included under the various pay items in the Bidding Sheets.

Other material necessary for the restoration procedures will be paid for under various items in the Bidding Sheets.

Disposal of asphalt and concrete will be made to an N.J.D.E.P. approved recycling facility. The Contractor shall notify the Recycle Facility to provide the County with appropriate credit for recycling.

SECTION 302 –AGGREGATE BASE COURSE

302.01 DESCRIPTION

THE FOLLOWING IS ADDED:

Dense Graded Aggregate shall be used as base material to construct new paths and widen existing paths as directed by the Engineer.

302.04 Measurement and payment.

THE FOLLOWING IS ADDED:

Payment for Dense Graded Aggregate will be the quantity as above described, at the price bid per ton bid for the item **Dense Graded Aggregate Base Course, 4” Thick** in the Bidding Sheets.

SECTION 401 – HOT MIX ASPHALT (HMA) COURSES

THE SUB-SECTION IS CHANGED AS FOLLOWS:

All work associated with this item shall be in accordance with Section 400 of the Standard Specifications and as herein described.

Hot Mix Asphalt 9.5M64 Surface Course (HMA), will be installed at an average thickness of 2 ½ inches on milled cart paths, widened paths and new path surfaces as specified herein.

A tack coat will be applied between all courses of HMA, prior to placement of the course. In addition, tack coat will be applied to the joint edge of each course where it meets existing asphalt or where only a thin overlay was placed. Additional compensation will not be made for the placement of tack coat. All costs associated with this work will be included in the unit price bid for the item Hot Mix Asphalt 9.5M64 Surface Course, 2 ½” Thick.

Sawcuts, if and where directed by the Engineer, shall consist of making longitudinal and transverse cuts in existing pavement, sidewalk, driveways or curb, of whatever nature. Sawcuts shall be made with an approved power saw full depth in order to prevent damage to the existing pavement, sidewalk, driveways or curbs and to provide a neat edge for the adjacent proposed, sidewalk, driveways or curbs. Separate payment will not be made for sawcut but the cost

shall be included in the price bid for item Hot Mix Asphalt 9.5M64 Surface Course, 2 ½ ” Thick, as shown in the Bidding Sheets.

The Contractor shall take reasonable care and caution to preserve and protect all existing pavements, shrubs, grass areas, sidewalks, and private and public property beyond the limits of work. Damage to any of the above caused by careless construction procedures in the opinion of the Engineer shall be replaced at the Contractor’s expense. Any grass areas disturbed by the Contractor’s operations will be top soiled, fertilized, and seeded and provided with hay mulching. Separate payment will not be made for the restoration but the cost shall be included in the unit price bid for item Hot Mix Asphalt 9.5M64 Surface Course, 2 ½ ” Thick, as shown in the Bidding Sheets.

401.02.01 Materials

EMULSIFIED ASPHALT UNDER TACK COAT IS REVISED TO:

Emulsified Asphalt, Grade RS-1, CRS-1, SS-1, SS-1h, Grade CSS-1 or CSS-1h.....902.01.03

401.02.02 Equipment

THE LAST PARAGRAPH IS CHANGED TO:

When an MTV is used, install a paver hopper insert with a minimum capacity of 14 tons in the hopper of the HMA paver.

401.03.01 Preparing Existing Pavement

401.03.01. A Milling of HMA.

THE FOLLOWING IS ADDED AFTER THE FOURTH PARAGRAPH:

Sawcut at the limit of paving at limits requiring a neat edge between new and existing HMA.

THE FOLLOWING IS ADDED:

401.03.02 Tack Coat and Prime Coat

TABLE 401.03.02-1 IS CHANGED TO:

Table 401.03.02-1 Tack Coat Application			
Material	Spraying Temp, °F	Gallons per Square Yard	Season
Cut-Back Asphalt:			
RC-70	120 to 190	0.05 to 0.15	Oct 15 to Apr 15
Emulsified Asphalt:			
RS-1	70 to 140	0.05 to 0.15	All year
CRS-1	125 to 185	0.05 to 0.15	All year
SS-1, SS-1h	70 to 140	0.05 to 0.15	All year
CSS-1, CSS-1h	70 to 140	0.05 to 0.15	All year

TABLE 401.03.02-2 IS CHANGED TO:

Table 401.03.02-2 Prime Coat Application			
Cut-Back Asphalt	Spraying Temp, °F	Gallons per Square Yard	Season
MC-30	85 to 150	0.1 to 0.5	Oct 15 to Apr 15
MC-70	120 to 190	0.1 to 0.5	Oct 15 to Apr 15
Emulsified Asphalt:			
CSS-1	70 to 140	0.1 to 0.50	All year

401.03.03 HMA Courses

D. Transportation and Delivery of HMA.

THE FIRST PARAGRAPH IS CHANGED TO:

Deliver HMA using HMA trucks in sufficient quantities and at such intervals to allow continuous placement of the material. Do not allow trucks to leave the plant within 1 hour of sunset unless nighttime lighting is provided as specified in 108.06. The RE will reject HMA if the HMA trucks do not meet the requirements specified in 1009.02. The RE will suspend construction operations if the Contractor fails to maintain a continuous paving operation. Before the truck leaves the plant, obtain a weigh ticket from a fully automatic scale. Before unloading, submit for each truckload a legible weigh ticket that includes the following:

1. Name and location of the HMA plant.
2. Project title.
3. Load time and date.
4. Truck number.
5. Mix designation.
6. Plant lot number.
7. Tare, gross, and net weight.

THE ENTIRE SUBSECTION IS CHANGED TO:

The mixture shall be transported from the mixing plant to the Project in trucks equipped with tight, clean bodies, which may be lightly coated with soap or lime solution, or other such non-petroleum-based release agent. Under no circumstance shall a petroleum-based product be used as a release agent. The trucks shall be permanently equipped with an airfoil that is capable at any speed or under any weather conditions to deflect air over the tarp and to prevent air from going under the tarp. The airfoil will be affixed no more than 2 feet in front of the tarp roll and be at least as high as the top of the tarp roll.

Each truckload shall be covered immediately after loading at the plant with a waterproof tarpaulin of such size to protect the mixture from the weather. The tarpaulin shall be able to withstand normal handling and placement temperatures of up to 400 °F without endangering the structural integrity and serviceability of the fabric. The tarpaulin shall also comply with one of the following:

1. A heavyweight tarpaulin to completely drape the load. The heavyweight tarpaulin shall have a minimum weight of 18 oz./yd² and shall be a minimum of 2 feet wider and 4 feet longer than the truck body. The heavyweight tarpaulin shall securely meet or overlap the top of the tailgate and be securely held in place so as to prevent air from lifting the tarp during transport.
2. A tarpaulin equipped with side and back flaps sufficient to lap down outside along the sides and rear of the truck bed a minimum of 12 inches. The tarpaulin shall be secured by tie downs at a maximum of 5 feet spacing along the sides and rear of the truck.

The truck bodies shall be insulated or heated as necessary, to ensure delivery of the mixture at the specified temperature. Any truck that: causes excessive segregation of the mixture by its suspension or other contributing factors; leaks; causes delays; does not have an airfoil; or does not have an approved tarpaulin shall be removed from the work until such conditions are corrected and the truck is presented for inspection to the Engineer. The Engineer may require that all vehicles for transporting HMA mixture to be used by the contractor be made available for inspection at the plant laboratory prior to any shipments of materials.

Course conditions require that trucks delivering material be limited to hauling no more than ten (10) tons. Larger loads will be permitted only when approved by the Engineer. Approval will be given on a daily basis and will be governed by the Engineer's evaluation of ground conditions.

SECTION 602 – DRAINAGE STRUCTURE

602.01 Description

THE FOLLOWING IS ADDED:

Contractor shall be responsible for construction of channel drains at locations along the path as directed by the Engineer.

PART 1 GENERAL

1.1 SUBMITTALS

- A. Product Data: Submit manufacturer's product data, including installation instructions.
- B. Shop Drawings: Submit manufacturer's shop drawings, indicating layout, materials, components, accessories, and dimensions.
- C. Warranty: Submit manufacturer's standard warranty.

1.2 QUALITY ASSURANCE

- A. Single Source Responsibility: Provide channel drain system from single manufacturer.

1.3 DELIVERY, STORAGE, AND HANDLING

- A. Delivery: Deliver materials to site in manufacturer's original, unopened containers and packaging, with labels clearly identifying product name and manufacturer.
- B. Storage: Store materials in clean, cool, dry area in accordance with manufacturer's instructions. Do not store materials in direct sunlight.
- C. Handling: Protect materials during handling and installation to prevent damage.

PART 2 PRODUCTS

2.1 MANUFACTURER

- A. NDS, Inc., 851 North Harvard Avenue, PO Box 339, Lindsay, California 93247. Toll Free (800) 726-1994. Toll Free Fax (800) 726-1998. Phone (559) 562-9888. Fax (559) 562-4488. Website www.ndspro.com. E-Mail nds@ndspro.com. *or Approved Equal.*

2.2 PRO SERIES CHANNEL DRAINS

- A. Channel Drain:

1. Description: 5-inch wide deep profile polyolefin channel drain system, NDS3#800, with mechanical interlocking joints, installation feet and integrated knock out bottom outlet.

2.3 CHANNEL GRATES

5" x 20" Ductile Channel Grate:

1. Part Number: 823
2. Description: 5" Wide Heavy Duty Ductile Iron Heavy Traffic Channel Grate.
3. Grate Openings: 9/16" x 3- 9/16".
4. Open Surface Area: 25.03 square inches per foot.
5. Inlet Capacity: 32.79 gpm per foot.
6. Load: 326 to 575 psi at speeds less than 20 mph.
7. Color: Black

2.4 ACCESSORIES

A. 5" Deep Profile End Cap:

1. Part Number: 812.

B. 5" Deep Profile 3" S&D Pipe Hub & 4" S&D Fitting End Outlet:

1. Part Number: 811.

PART 3 EXECUTION

3.1 EXAMINATION

A. Examine areas to receive channel drain system. Notify Engineer if areas are not acceptable. Do not begin installation until unacceptable conditions have been corrected.

3.2 INSTALLATION

A. Install channel drain system in accordance with manufacturer's instructions for Class "D" Load Application at locations as directed by the Engineer.

B. Excavate trench to ensure proper thickness of concrete beneath and on both sides of channel is maintained and in accordance with designed load range.

C. Channel drain sections shall be installed in accordance with plan elevations and details.

D. Ensure directional flow arrows located on bottom of channel are pointing in direction of flow, toward catch basin and/or evacuation outlet.

E. Catch basins shall be installed at required elevation as located on plans and/or details.

F. Apply sealant to joints of channel drain system as directed by the manufacturer for watertight joint integrity.

G. Insure Blank Grate Inserts are installed if removed during installation procedure. Loosen grate screws to slide Blank Grate Inserts longitudinally to insure joint alignment is maintained during concrete placement. Tighten grate screws to maintain Blank Grate Insert placement.

- H. Concrete:
 - 1. Place concrete beneath and on both sides of drain system in accordance with specified load design and plan details.
 - 2. Ensure concrete has a minimum compressive strength of 3,500 psi at 28 days.
- I. Recess top of drain system 1/8” below concrete finish grade for pedestrian applications and 1/4” for traffic bearing applications.
- J. Allow concrete to cure to specified compressive strength. Remove Blank Grate Inserts, save grate screws and dispose of Blank Grate Inserts in a proper manner. Blank Grate Inserts are recyclable and should be recycled if proper facilities exist. Insure sediment and debris does not collect in channel.
- K. Clean channel of any accumulated sediment and/or debris prior to final project completion.

3.3 PROTECTION

- A. Protect installed channel drain system from damage during construction.

602.04 Measurement and Payment

The following is **added**:

<u>Item</u>	<u>Pay Unit</u>
Channel Drain	L.F.

SECTION 607 – CURBS

607.01 Description.

THE FOLLOWING IS ADDED:

All work associated with this item shall be in accordance with Section 607.03.07 of the Standard Specifications and herein described. HMA Curb will be installed at locations as directed by the Engineer. The cost for the application of tack coat material shall be included in the unit price bid for this item .

607.04 Measurement and Payment

THE FOLLOWING IS ADDED:

<u>Item</u>	<u>Pay Unit</u>
6” x 8” HOT MIX ASPHALT CURB	LINEAR FEET

SECTION 901 – AGGREGATES

901.10.03 Virgin and RAP Mixture

3. Density Control

THE FOLLOWING IS ADDED:

When AASHTO T 310 (Direct Transmission Method, nuclear gauge method for measuring density and moisture content) is used to perform Compaction Acceptance Testing (Subsection 302.03.01), **a representative sample of five tests for each 5,000 square yards lot will be taken.**

SECTION 902 – ASPHALT

902.02.02 Composition of Mixtures

TABLE 902.02.02-2 IS CHANGED TO:

Table 902.02.02-2 Additional Fine Aggregate Requirements for HMA		
Tests	Test Method	Minimum Percent
Uncompacted Void Content of Fine Aggregate	AASHTO T 304, Method A	45
Sand Equivalent	AASHTO T 176	45

902.02.04 Sampling and Testing

B. Sampling.

THIS ENTIRE PART IS CHANGED TO:

The ME will take a random sample from each 700 tons of production for volumetric acceptance testing and to verify composition.. The ME will perform sampling according to AASHTO T 168, NJDOT B-2, or ASTM D 3665.

902.03.02 Mix Design

THE FOLLOWING IS ADDED TO THIS SUB-SECTION:

UNLESS OTHERWISE APPROVED BY THE ENGINEER, ONLY ONE SOURCE OF SUPPLY FOR HOT MIX ASPHALT MATERIAL MAY BE USED ON THE PROJECT.

THE FOURTH PARAGRAPH IS CHANGED TO:

The ME will test 2 specimens to verify that the final JMF produces a mixture that has a minimum void content as specified in Table 902.03.03-1. The ME will determine percent air voids according to AASHTO T 209, and either NJDOT B-6 or AASHTO T 331.

902.03.03 Sampling and Testing

THE FOLLOWING IS ADDED TO THE FIRST PARAGRAPH:

Ensure that the mix meets the requirements as specified in 902.02.04.A, otherwise the RE or ME will reject the material.

THE SECOND PARAGRAPH IS CHANGED TO:

During production, the ME will take one random acceptance sample from each 700 tons of production to verify composition. Conduct air voids and drain down tests as directed by the ME.

THE FOURTH PARAGRAPH IS CHANGED TO:

The ME will perform sampling according to NJDOT B-2 or ASTM D 3665, and will perform testing for composition according to AASHTO T 308 or NJDOT B-5. Perform testing for air voids according to AASHTO T 209 and either NJDOT B-6 or AASHTO T 331. Perform testing for drain down according to NJDOT B-7 or NJDOT B-8.

902.04.03 Sampling and Testing

THE FIRST PARAGRAPH IS CHANGED TO:

Ensure that the mix meets the requirements as specified in 902.02.04.A, otherwise the RE or ME will reject the material. Maintain the temperature of the mix between 300 °F and 330 °F. Perform and meet requirements for quality control testing as specified in 902.02.04.C.

THE SECOND PARAGRAPH IS CHANGED TO:

During production, the ME will take one random acceptance sample from each 700 tons of production to verify composition. Conduct drain down tests as directed by the ME.

902.05.01 Composition of Mixture

THE FIFTH PARAGRAPH IS CHANGED TO:

For fine aggregate, use stone sand conforming to 901.05.02. Ensure that the combined fine aggregate in the mixture conforms to the requirements in Table 902.02.02-2.

902.05.02 Mix Design

THE FIRST PARAGRAPH IS CHANGED TO:

Design the SMA to meet the requirements in Table 902.05.02-1 and Table 902.05.02-2. Prepare the JMF according to AASHTO R 46. Determine the JMF at 4 percent air voids and 75 gyrations of the Superpave gyratory compactor.

TABLE 902.05.02-2 IS CHANGED TO:

Table 902.05.02-2 SMA Mixtures Volumetric For Design and Plant Production		
Property	Production Control Tolerances	Requirement
Air Voids	±1%	4.0%
Voids in Mineral Aggregate (VMA)	–	17.0% minimum
VCA _{mix}	–	Less than VCA _{dry}
Drain down @ production temperature	–	0.30% maximum
Asphalt Binder Content (NJDOT B-5)	±0.15%	6% minimum
Asphalt Binder Content (AASHTO T 308)	±0.40%	6% minimum
Tensile Strength Ratio (AASHTO T 283)	–	80% minimum

902.05.03 Sampling and Testing

THE FOLLOWING IS ADDED TO THE FIRST PARAGRAPH:

Ensure that the mix meets the requirements as specified in 902.02.04.A, otherwise the RE or ME will reject the material.

THE SECOND PARAGRAPH IS CHANGED TO:

During production at the plant, the ME will take a sample from each 700 tons of production to verify composition and air voids. Conduct drain down, VCA_{mix}, VCA_{dry}, and VMA testing as directed by the ME. Perform tests according to AASHTO R 46.

THE FOURTH PARAGRAPH IS CHANGED TO:

The ME will perform sampling according to NJDOT B-2 or ASTM D 3665, and will perform testing for composition according to AASHTO T 308, or NJDOT B-5. The ME will determine bulk specific gravity of the compacted sample according to AASHTO T 166 or AASHTO T 331. The ME will use the most current QC maximum specific gravity test result, obtained according to AASHTO T 209, in calculating the volumetric properties of the SMA. Perform testing for drain down according to AASHTO T 305.

902.06.03 Sampling and Testing

THE FOLLOWING IS ADDED TO THE FIRST PARAGRAPH:

Ensure that the mix meets the requirements as specified in 902.02.04.A, except that the temperature of the mix at discharge is required to be between 230 °F and 275 °F, otherwise the RE or ME will reject the material.

THE SECOND PARAGRAPH IS CHANGED TO:

During production, the ME will take one random acceptance sample from each 700 tons of production to verify composition. Conduct drain down tests as directed by the ME.

SECTION 903 - CONCRETE

903.02 Chemical Admixtures.

903.02.05 Corrosion Inhibitor Admixture

THE FOLLOWING IS ADDED:

Corrosion inhibitor products that are to be used in the fabrication of concrete items shall be as follows:

903.07 Quick-Setting Patch Materials

Use quick-setting patch material that is listed on the qualified products list (QPL) and is ready for mixing according to the manufacturer's recommendations. Follow the manufacturer's recommendations regarding the required water demand for the patching material. Use patching material that is concrete gray in color and contains no calcium chloride or other ingredients that cause corrosion to steel reinforcement. If adding coarse aggregate to patching material, use broken stone conforming to 901.03.01. Ensure that the material is quick-setting for use in concrete patching where fast setting, rapid strength gain, non-shrink, and high bond strength characteristics are needed. The materials engineer (ME) will add products to the QPL only after testing and evaluation in the field, after service for 1 year.

The classifications for quick-setting patch materials are as follows:

1. **Type 1A.** Suitable for use above water. Type 1A products have manufacturer specified mix proportions with aggregates that would preclude it from being classified as a Type 1. The ME will approve the mix proportions before adding the material to the QPL. The manufacturer shall provide mixing proportions, including the required type and size of aggregate and the proportion of patching material, aggregate/sand, and water. At least 10 days before the start of placement, propose aggregates for verification trial batching based on the manufacturer's pre-approved proportions. The ME will verify that the proposed quick setting patch mixture meets the required physical properties.
2. **Type 1B.** Suitable for use above water. Type 1B products are those products that have coarse aggregate, sand, or both pre-packaged with the cementitious material. The ME will test this material, including a field

trial, prior to adding it to the QPL. The manufacturer shall designate the amount of aggregate and shall maintain the total aggregate within ± 10 percent of this stated amount. The ME will randomly test the aggregate to ensure that the overall percentage of aggregate is within ± 10 percent of the total and that the gradation on individual sieves does not vary more than ± 10 percent from the gradation of the originally approved sample. The manufacturer shall use an aggregate supplier that is listed on the QPL. The ME will disapprove quick-setting patch material that fails to comply with the aggregate consistency requirements. If the manufacturer makes any changes to the formulation, the ME will require that the material be resubmitted for approval. Do not add additional aggregate in the field.

If liquid activator, other additives, adhesive, or bonding agents are integral to the performance of the patch material, the manufacturer shall provide the material so that 1 package of additive, activator, adhesive or bonding agent is required for 1 package of patch material. Mix patch material as specified in 903.03.04.

Use quick setting patch material that meets the requirements in Table 903.07-1 when tested according to NJDOT C-2. Mix quick-setting patch according to the manufacturer's recommendations.

**Table 903.07-1 Requirements for Quick Setting Patch Material
Type 1A and 1B**

Bond Strength	
7-day (minimum)	1000 psi
28-day (minimum)	2000 psi
Expansion/ Shrinkage	
Cured in Water (maximum)	+0.20%
Cured in Air (maximum)	-0.20%
Difference (maximum)	0.30%
Durability	
Retained strength at 50 cycles (minimum)	90%
Visual condition rating at 50 cycles (maximum)	3
Permeability (maximum chloride content at 2 inches)	2.5 lbs/yd ³
Compressive Strength	
3-hour (minimum)	2000 psi
1-day (minimum)	3000 psi
7-day (minimum)	4000 psi
28-day (minimum)	4500 psi
Time of Set in minutes (minimum)	15

THE FOLLOWING IS ADDED:

903.11 Membrane Waterproofing

As per the Manufacturers Specifications

(NOT FOR USE WITH COLORED CONCRETE PRODUCTS)

Calcium Nitrite Based as produced by
W.R. Grace & Company
2133 85th Street
North Bergen, NJ 07047
Telephone: 201-869-5220

Calcium Nitrite Based as produced by
The Euclid Chemical Company
5 Joanna Court
East Brunswick, NJ 08816
Telephone: 732-390-9770

Calcium Nitrite Based as produced by
Master Builders Inc.
798 Welsh Road
Huntingdon Valley, PA 19006
Telephone: 215-938-7501

Calcium Nitrite Based as produced by
SIKA Corporation
201 Polito Avenue
Lyndhurst, NJ 07071
Telephone: 800 - 933 - SIKA (7452)

Calcium Nitrite Based as produced by
Great Eastern Technologies, LLC
“Chem Strong CI”
515 Route 528
P. O. Box 3015
Lakewood, NJ 08701
Telephone: 888 - 452 – 9348

SECTION 1009 – HMA PLANT EQUIPMENT

1009.01 HMA PLANT

A. Requirements for HMA Mixing Plants.

THE FOLLOWING IS ADDED AFTER THE SECOND PARAGRAPH:

The HMA producer is required to have a quality control (QC) program plan approved annually by the ME as per Materials Approval Procedure MAP-102. The HMA producer is required to ensure that the QC plan conforms to the requirements outlined in the report entitled “Hot Mix Asphalt Quality Control Program Plan” prepared by the Department of Transportation and New Jersey Asphalt Paving Association. Failure to follow these requirements will result in rejection of HMA materials supplied by the HMA producer and removal of the HMA supplier from the QPL.



COUNTY OF UNION

Galloping Hill Golf Cart Path Improvement Project



Legend

- Local Roads
- Interstate
- US Highway
- State Highway
- County Highway
- Garden State Parkway
- County Park
- Municipal Boundary
- Rail Roads

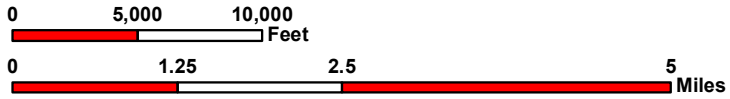
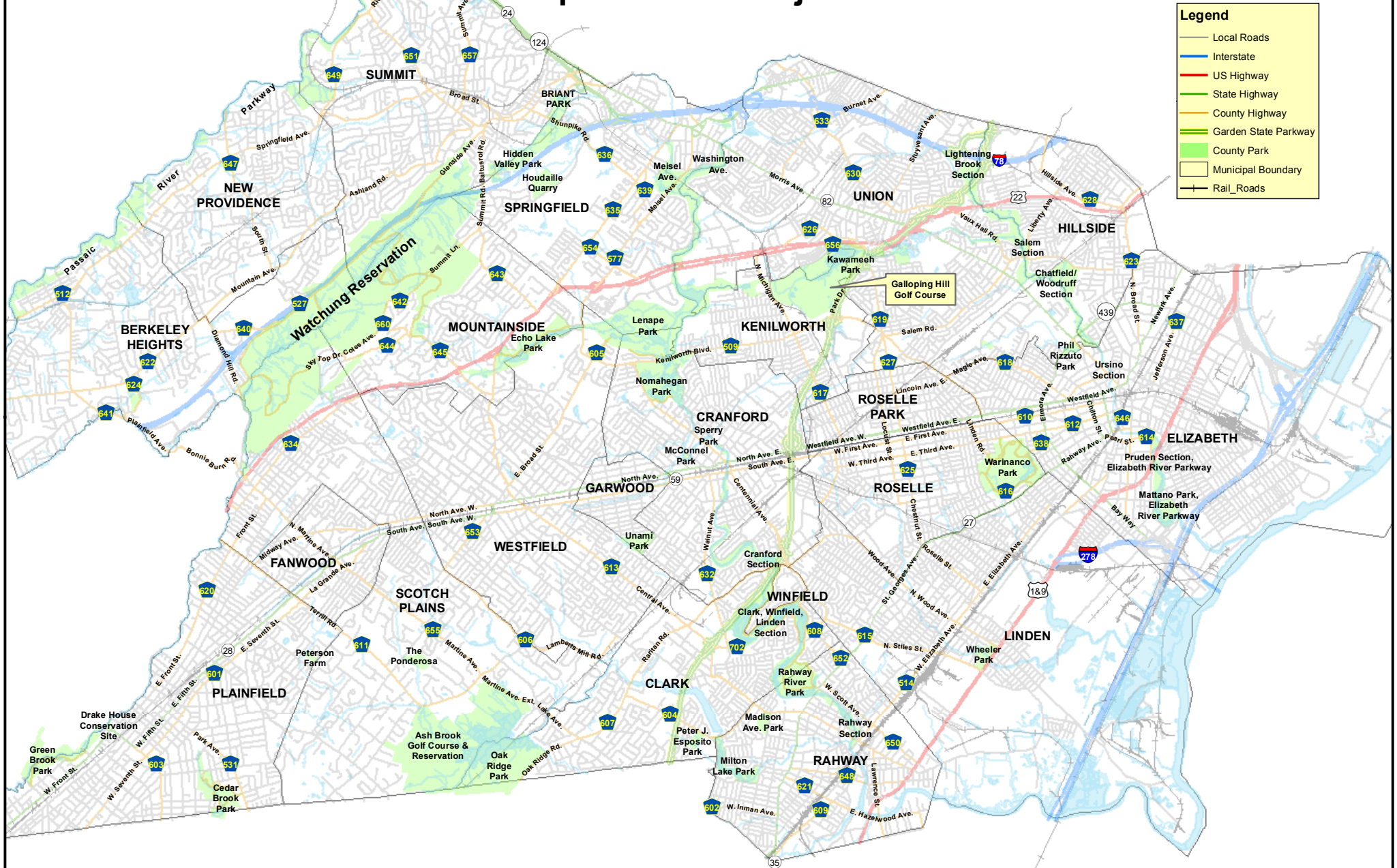

Data Provided for the County of Union
Bureau of GIS, Digitized 09/2013
Projection: NJ State Plane Feet, NAD 83
Created: July 8, 2015

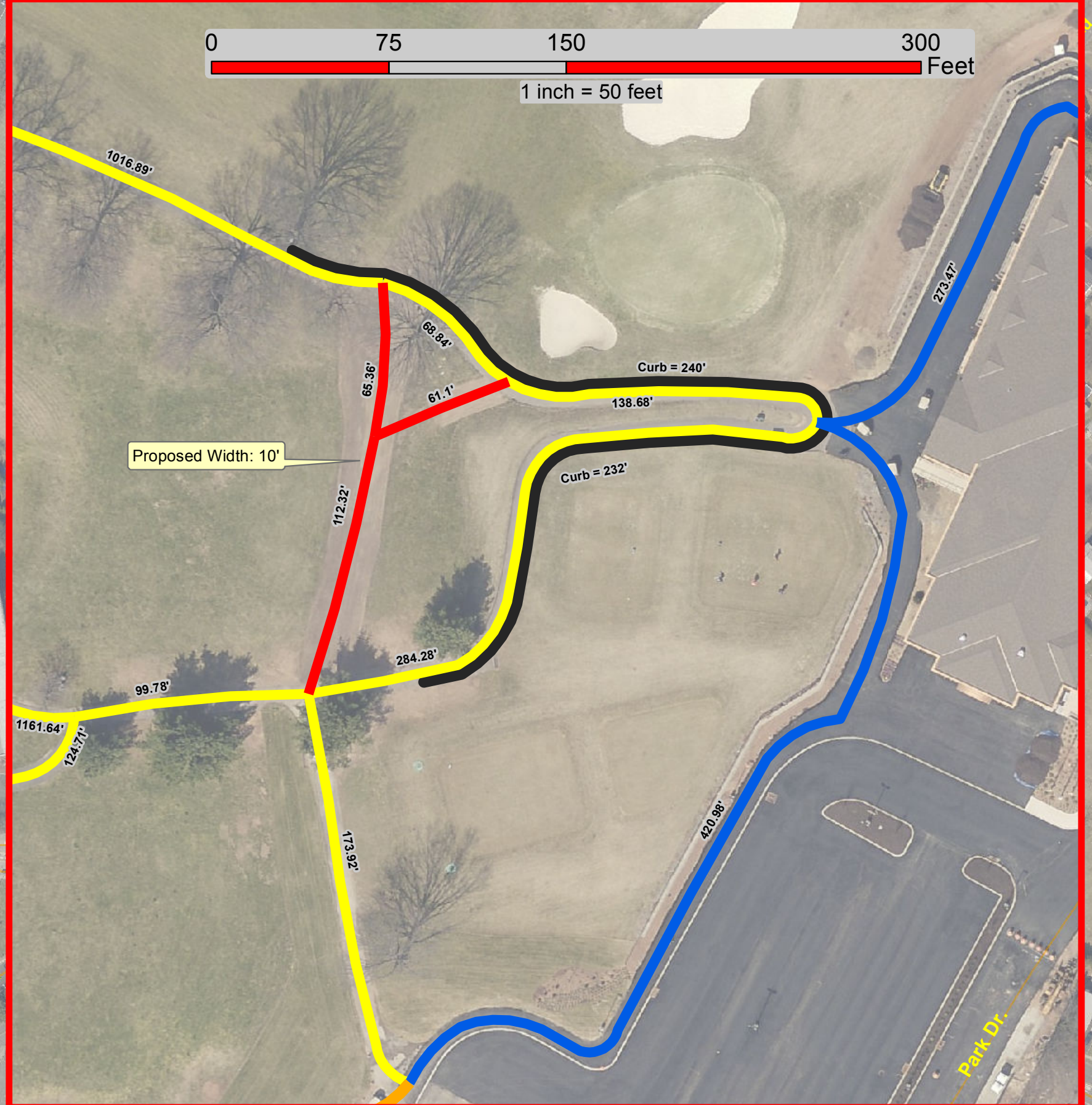
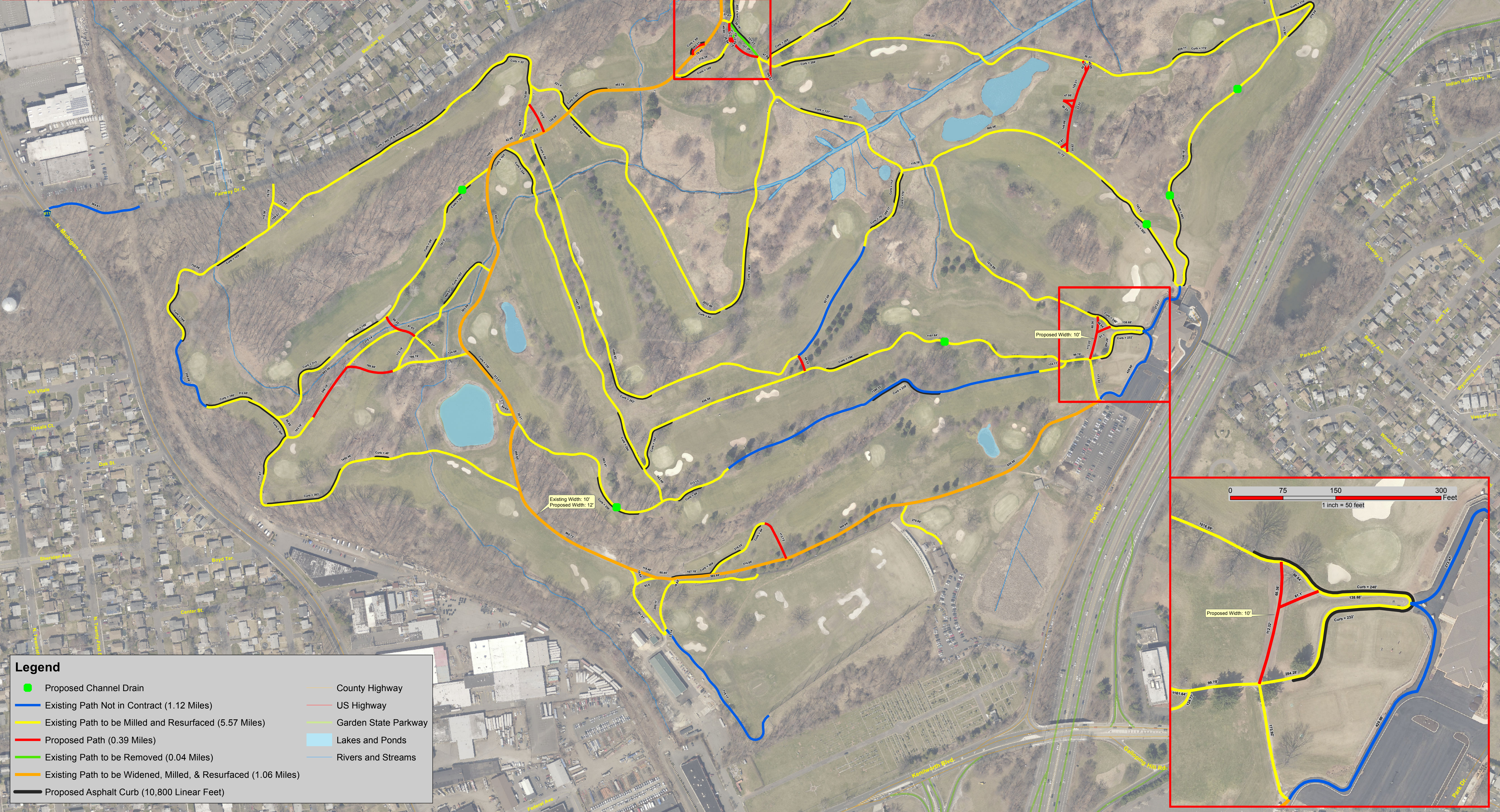
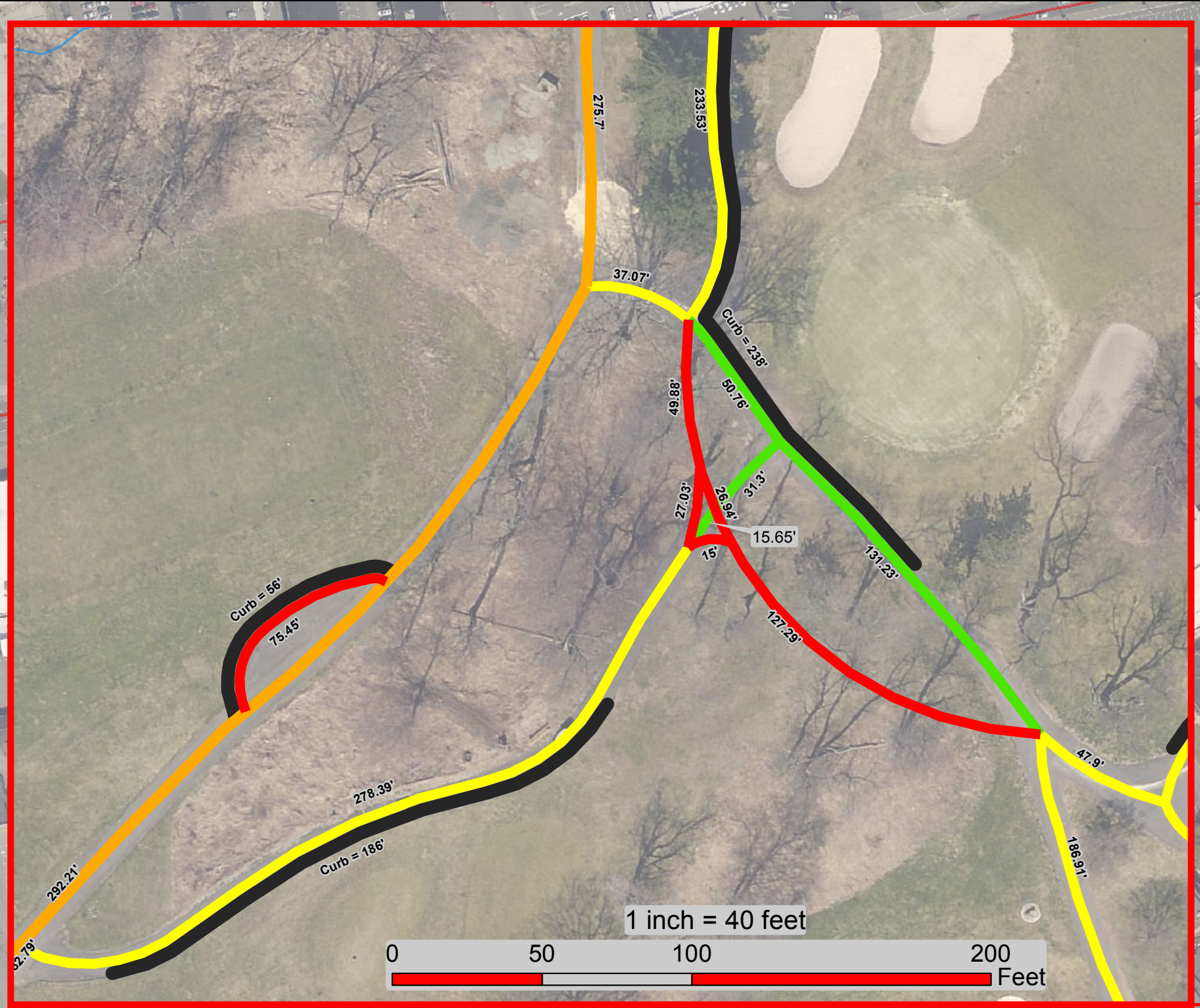
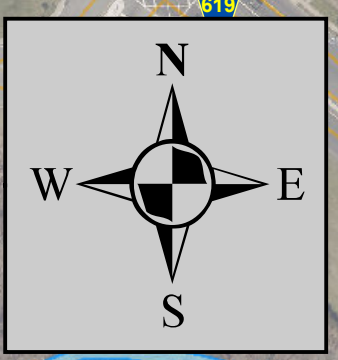

Legend			
	Proposed Channel Drain		County Highway
	Existing Path Not in Contract (1.12 Miles)		US Highway
	Existing Path to be Milled and Resurfaced (5.57 Miles)		Garden State Parkway
	Proposed Path (0.39 Miles)		Lakes and Ponds
	Existing Path to be Removed (0.04 Miles)		Rivers and Streams
	Existing Path to be Widened, Milled, & Resurfaced (1.06 Miles)		
	Proposed Asphalt Curb (10,800 Linear Feet)		

Existing Width: 10'
Proposed Width: 12'

Proposed Width: 10'



Galloping Hill Golf Cart Path Improvement Project
Union County Project Number: 2015-014 Appendix B

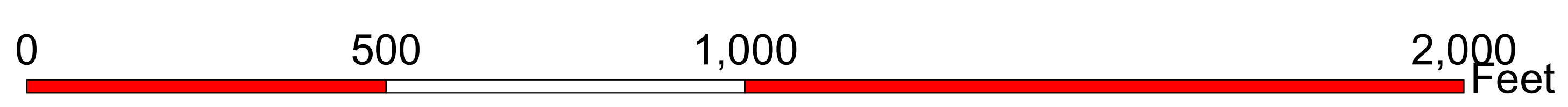

1:1,725

*Aerial Date: May 2013
Measurements are Approximate

Map Number: 090301
Map Provided by the Bureau of GIS.
Created: September 3, 2015

HAVE YOU SEEN THE NEW AND IMPROVED PRO SERIES CHANNEL DRAIN?

Never ones to rest on our laurels, at NDS we've taken our popular, easy-to-install Pro Series Channel Drain... and made it even better.

We originally designed the Pro Series System to be flexible, easy, and fast to install, with a patented modular design, the ability to insert outlets along any location in the channel run, and end cap and outlet fittings that slide easily into place. In 2011, we're keeping all those features – and adding the following new ones:

- Channel-to-channel clips for **reduced motion during installation**
- Rebar clips instead of lower mount clips for an **easier install**
- New side ribs for **increased strength**
- Lay-Flat design **stabilizes channel** during installation
- Thicker channel walls for **additional strength**

All this, and the channel still fits easily with all grates and end connectors. For additional product details, see page 34.

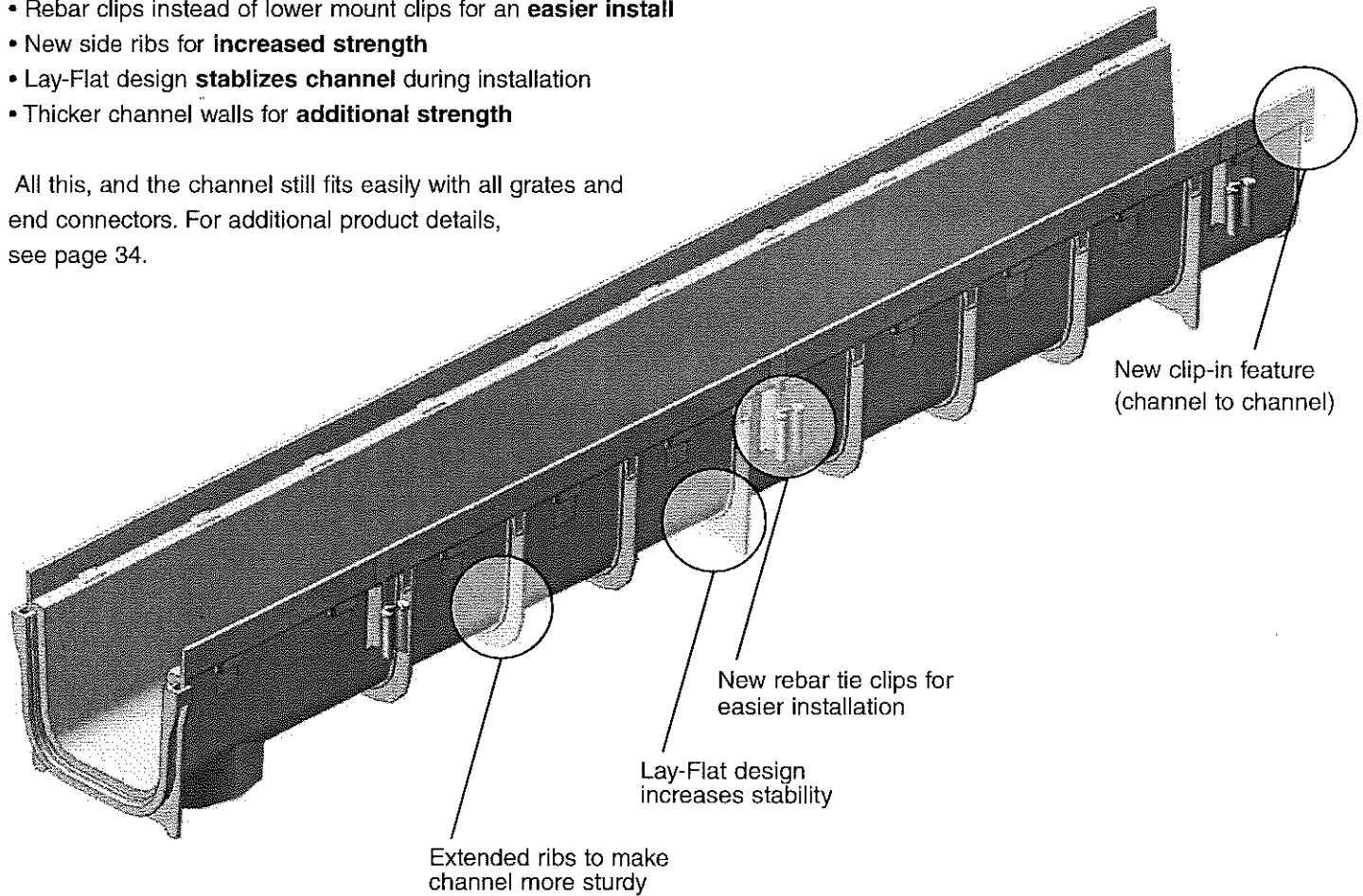

Details

- Create a channel as long as you need, or reduce to lengths as short as 4" for smaller, interlocking sections.
- End cap/knock-out end and outlet fitting simplifies assembly and installation.
- Flexible and easy: side and bottom outlets can be inserted at any location along the channel run.
- Available in four widths: 3", 5", 8" and 12"
- Available in two depths: deep for heavy flows, shallow for slabs or where little fall depth is available.
- Modular design comes in ½ meter (19 1/16") and 1 meter (39 3/8") pieces with interlocking end joints.
- Joints eliminate couplings and are specially designed to withstand concrete expansion and contraction.

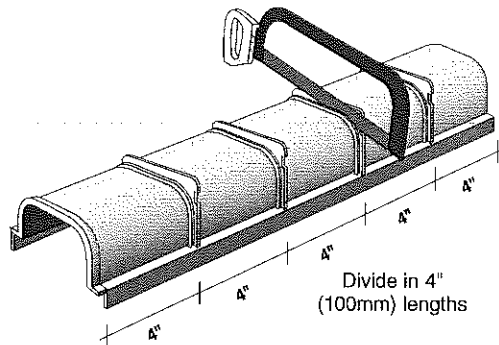

Materials and Standards

- Polypropylene creates a structurally-compact, water tight channel.
- All parts contain UV inhibitors to prevent fading and cracking.

Load Recommendations

- Pedestrian Grates offer heel-proof pattern.
- Polyolefin Light Vehicular Grate for use in areas with passenger vehicles and light trucks with speeds less than 20 MPH.
- Load Star or Ductile Channel Grates for heavy-duty traffic.
- See individual products for details.

Pre-assembled Channel Drain Systems

Our Modular Pro Series channel drains also come in pre-assembled kits to decrease installation time. They act as perimeter drains, quickly removing water from hardscapes and directing it away from building structures.

The new 3" and 5" wide pre-assembled channel drains include a one meter (39 3/8") of channel drain and grate, 1 end outlet, and 1 end cap. A bottom outlet is built into each channel section. This allows for easy ordering and less inventorying, as everything is included under one part number.

Our unique Pro Series interlocking channel design allows each channel to securely lock to the next for a secure, tight fit, with no couplings required. The pre-assembled Pro Series Channel drains are a great solution for your drainage needs.

NDS #864
Polypropylene

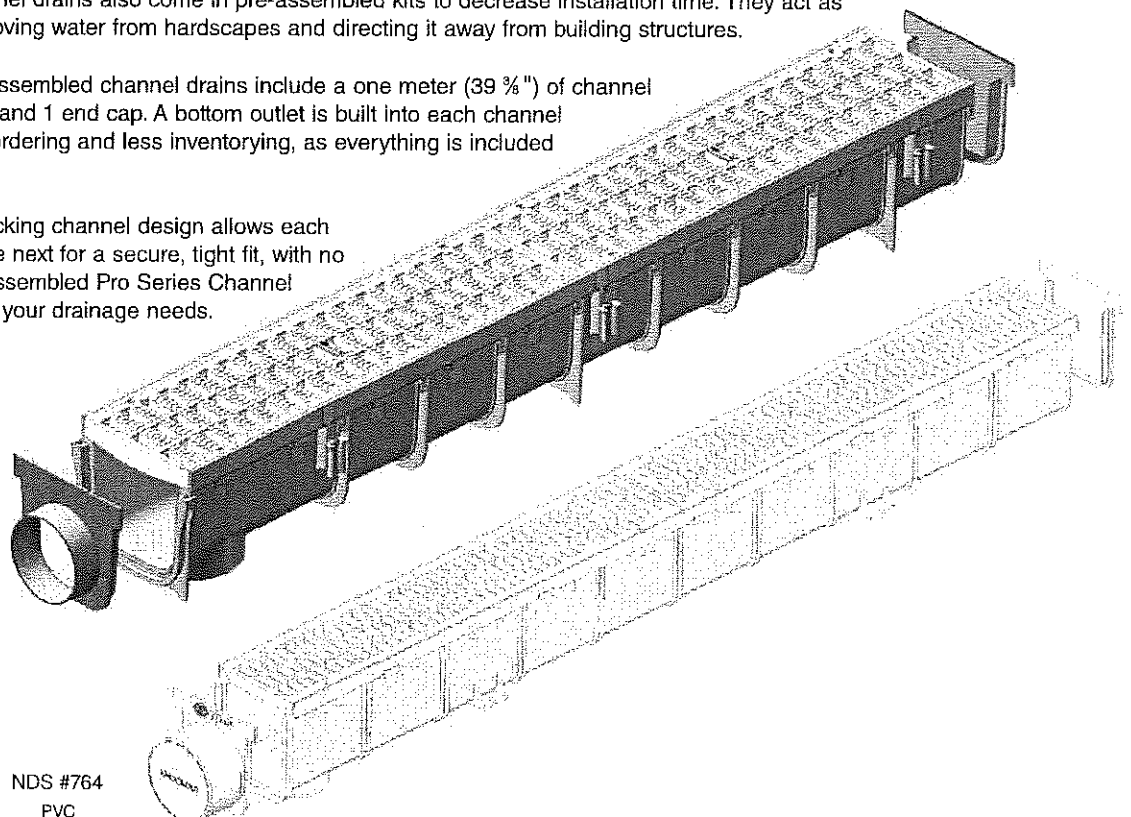

Patented

5" PRO SERIES CHANNEL™ DRAINS

MODULAR CHANNEL DRAINS

*Produced under license of First Plast S.R.L.- Italy

Part No.	Description	Color	Pkg. Qty.	Wt. Ea. (lbs.)	Product Class	Specifications
864	5" x 1 Meter Light Traffic Grate & Channel Drain Kit	Light Gray	9	7.11	25IN	NDS #864, 5" Wide Structural Foam Polyolefin light traffic channel grate and deep profile Polypropylene channel drain with mechanical interlocking joint and UV inhibitors. Open surface area 25.12 square inches per foot. 32.91 GPM per foot.
864DISP	Includes 1 end outlet & 1 end cap 5" Pro Series Channel Display (9 Kits)		1	140.0	25IN	

39 3/4"

5 1/2"

5 1/2"

3/4"

4 1/2"

4 1/2"

3/8" x 1 1/4" Grate Opening

Grate should be recessed 1/8" below finish grade in non traffic applications. Grate should be recessed 1/4" in traffic applications.

Bottom outlet fits 3" and 4" S&D fittings

 (See pg. 48)

Part No.	Description	Color	Pkg. Qty.	Wt. Ea. (lbs.)	Product Class	Specifications
826	5" x 20" Pedestrian Traffic Channel Grate	Light Gray	10	1.00	25IN	NDS #826, 5" Wide UV protected Structural Foam Polyolefin pedestrian traffic channel grate. Open surface area 7.93 square inches per foot. 10.39 GPM per foot.

Requires #829 screws.

 (See pg. 48) ADA Compliant/Heel-proof

19 1/8"

5 3/8"

3/8" x 1 1/4" Grate Opening

Part No.	Description	Color	Pkg. Qty.	Wt. Ea. (lbs.)	Product Class	Specifications
814	5" x 20" Light Traffic Channel Grate	Light Gray	10	1.20	25IN	NDS #814, #815, #816, #817, #818, #819, 5" Wide Structural Foam Polyolefin light traffic channel grate with UV inhibitors. Open surface area 25.12 square inches per foot. 32.91 GPM per foot.
815	5" x 20" Light Traffic Channel Grate	Green	10	1.20	25IN	
816	5" x 20" Light Traffic Channel Grate	Black	10	1.2	25IN	
817	5" x 20" Light Traffic Channel Grate	Sand	10	1.20	25IN	
818	5" x 20" Light Traffic Channel Grate	Brick Red	10	1.20	25IN	
819	5" x 20" Light Traffic Channel Grate	White	10	1.20	25IN	

Requires #829 screws.

 (See pg. 48) ADA Compliant

19 1/8"

5 3/8"

3/8" x 1 1/4" Grate Opening

Part No.	Description	Color	Pkg. Qty.	Wt. Ea. (lbs.)	Product Class	Specifications
828	5" x 20" Load Star Heavy Traffic Channel Grate	Gray	10	2.0	25IN	NDS #828, 5" Wide UV protected high impact glass reinforced nylon heavy traffic channel grate. Open surface area 15.54 square inches per foot. 20.36 GPM per foot.

Requires 4 Screws per Grate
Requires #829 screws.

 (See pg. 48)

19 1/8"

5 3/8"

3/8" x 1 1/4" Grate Opening

Part No.	Description	Color	Pkg. Qty.	Wt. Ea. (lbs.)	Product Class	Specifications
823	5" x 20" Ductile Channel Grate	Black	1	10.00	25IN	NDS #823, 5" Wide Heavy Duty Ductile Heavy Traffic Channel Grate. Open surface area 25.03 square inches per foot. 32.79 GPM per foot.

Requires #829 screws.

 (See pg. 48) ADA Compliant

19 1/8"

5 3/8"

3/8" x 3 3/8" Grate Opening

Part No.	Description	Color	Pkg. Qty.	Wt. Ea. (lbs.)	Product Class	Specifications
829	Stainless Steel Screws, FH #6 x 1 1/4"	Steel	40	.15	25PF	



Note: All dimensions are nominal. All weights are for shipping purposes only. Availability is subject to change.



MODULAR CHANNEL DRAINS

5" PRO SERIES CHANNEL™ DRAINS

*Produced under license of First Plast S.R.L.- Italy

Part No.	Description	Color	Pkg. Qty.	Wt. Ea. (lbs.)	Product Class	Specifications
820	5" x 20" Shallow Profile Channel Drain*	Light Gray	10	1.35	25IN	NDS #820, 5" Wide Shallow Profile UV protected high impact PVC Channel Drain with Mechanical Interlocking Joint.

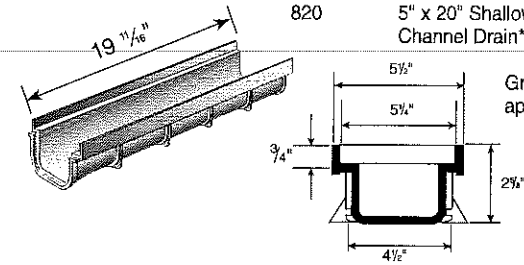

Grate should be recessed 1/8" below finish grade in non traffic applications. Grate should be recessed 1/4" in traffic applications.

Part No.	Description	Color	Pkg. Qty.	Wt. Ea. (lbs.)	Product Class	Specifications
821	5" Shallow Profile End Cap/ 1-1/2" SCH 40 SPT Knock Out End Outlet*	Light Gray	10	0.15	25IN	NDS #821, 5" Wide Shallow Profile high impact PVC End Cap/End Outlet.

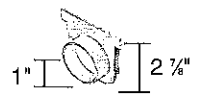

Part No.	Description	Color	Pkg. Qty.	Wt. Ea. (lbs.)	Product Class	Specifications
822	5" Shallow Profile 3" S&D SPT Bottom Outlet/ 1-1/2" SCH 40 SPT Side Outlet	Light Gray	10	0.60	25IN	NDS #822, 5" Wide Shallow Profile high impact PVC Bottom/Side Outlet.

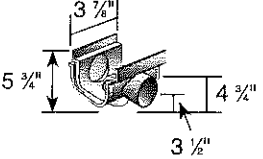

Part No.	Description	Color	Pkg. Qty.	Wt. Ea. (lbs.)	Product Class	Specifications
800	5" x 1 Meter Deep Profile Channel Drain	Light Gray	10	4.00	25IN	NDS #800, 5" Wide Deep Profile Polyolefin Channel Drain With Mechanical Interlocking Joints, Installation feet, integrated knock out bottom outlet.

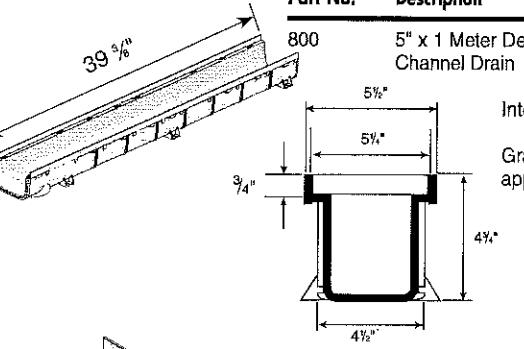

Integrated Knock out bottom outlet fits 3" and 4" S&D Fittings.

Grate should be recessed 1/8" below finish grade in non traffic applications. Grate should be recessed 1/4" in traffic applications.

Part No.	Description	Color	Pkg. Qty.	Wt. Ea. (lbs.)	Product Class	Specifications
811	5" Deep Profile 3" S&D Pipe Hub & 4" S&D Fitting SPT End Outlet	Light Gray	10	0.40	25IN	NDS #811, 5" Wide Deep Profile high impact PVC End Outlet.

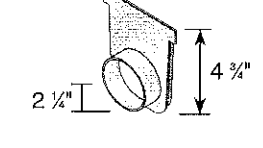

Part No.	Description	Color	Pkg. Qty.	Wt. Ea. (lbs.)	Product Class	Specifications
813	5" Deep Profile End Cap/3" S&D Hub & 4" S&D SPT Knock Out End Outlet	Light Gray	10	0.40	25IN	NDS #813, 5" Wide Deep Profile high impact PVC End Cap/End Outlet.

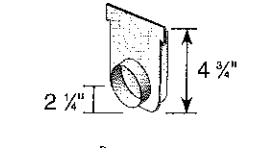

Part No.	Description	Color	Pkg. Qty.	Wt. Ea. (lbs.)	Product Class	Specifications
812	5" Deep Profile End Cap	Light Gray	10	0.20	25IN	NDS #812, 5" Wide Deep Profile high impact PVC End Cap.

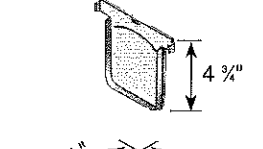

Part No.	Description	Color	Pkg. Qty.	Wt. Ea. (lbs.)	Product Class	Specifications
861	5" Deep Profile Grate & Channel Drain 90 Degree Elbow	Light Gray	1	3.44	25IN	

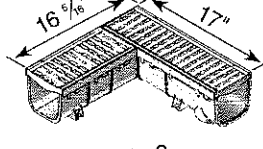

Part No.	Description	Color	Pkg. Qty.	Wt. Ea. (lbs.)	Product Class	Specifications
862	5" Deep Profile Grate & Channel Drain 45 Degree Elbow	Light Gray	1	3.44	25IN	

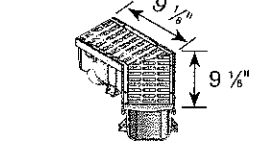

Note: All dimensions are nominal. All weights are for shipping purposes only. Availability is subject to change.



To place an order, visit: ndspro.net, fax: 1-800-726-1998 or call 1-800-726-1994.

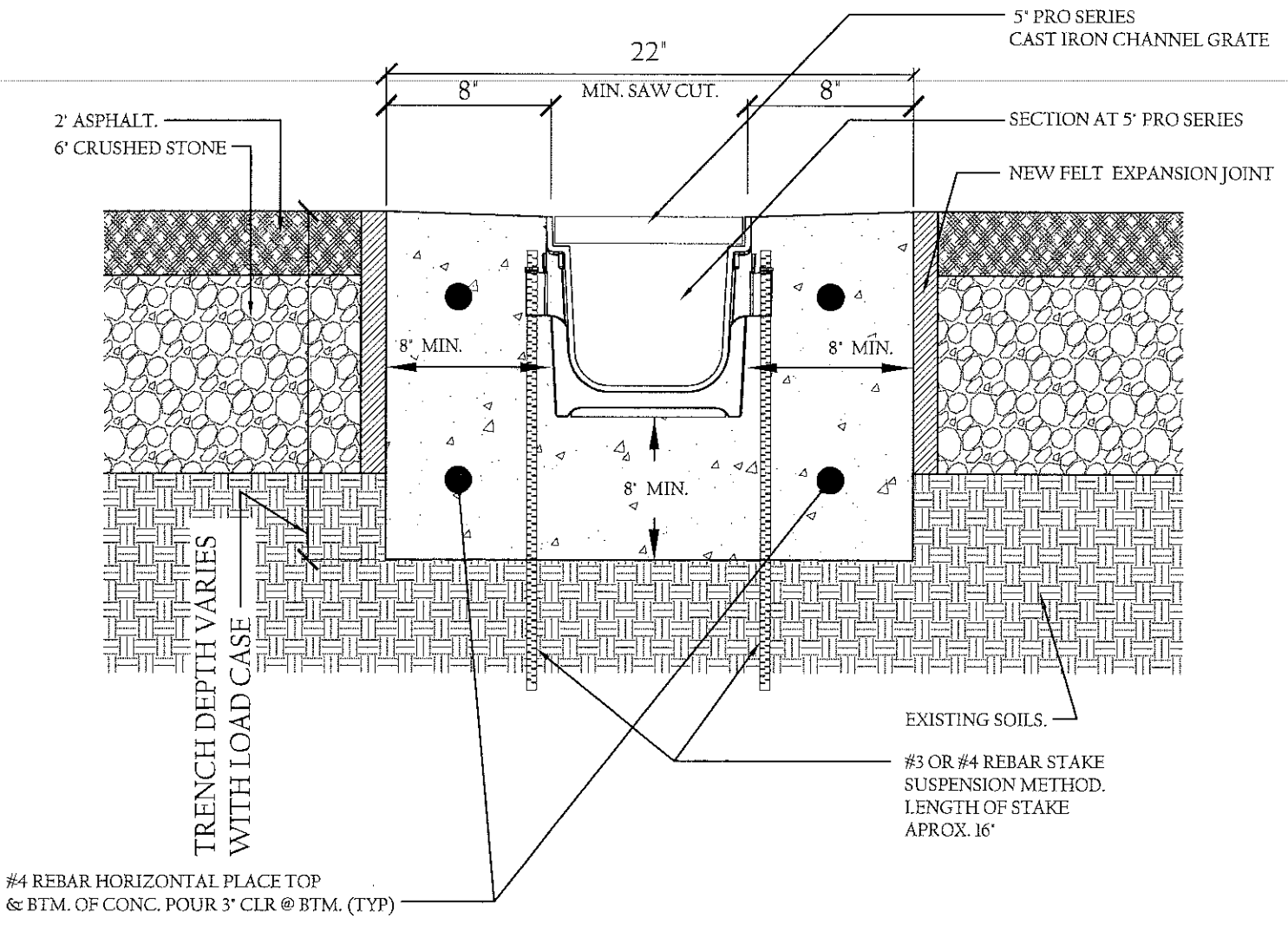

NOTE:

- CHANNELS TO BE INSTALLED WITH GRATE. GRATE TO BE PROTECTED FROM CONCRETE POUR.

SET TRENCH DRAIN IN CHANNEL SURROUNDED BY 8" OF CONCRETE OR THICKNESS OF THE CONCRETE SLAB WITH A MINIMUM OF 3,500 P.S.I. AVOID FULL LOAD TRAFFIC FOR 28 DAYS OR UNTIL CONCRETE HAS COMPLETELY HARDENED.



TECHNICAL SERVICES
1-888-825-4716
techservice@nldspro.com

TYPICAL 5" PRO SERIES INSTALLATION

CLASS 'D' 8' LOAD APPLICATION FOR CONCRETE / REBAR SUSPENSION METHOD W/ ASPHALT.

N.T.S.

Proposed Path
 -HMA 9.5M64 Surface Course, 2 1/2" thick.
 -Dense Graded Aggregate Base Course 4" thick
 -Excavation Unclassified

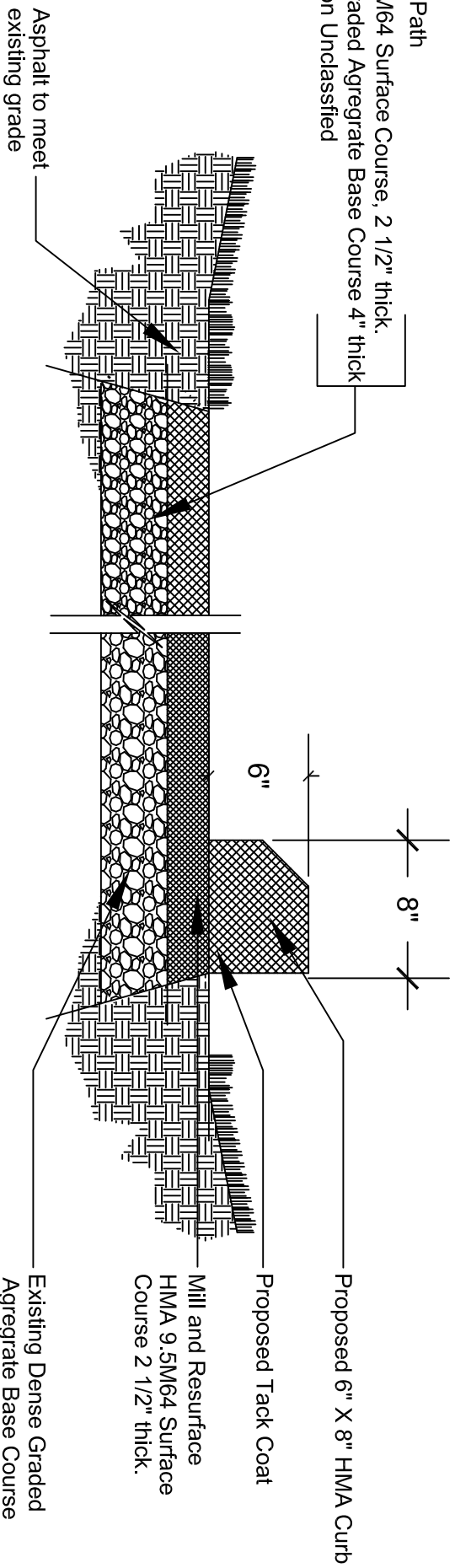

1. Curb must be made with a machine - not by hand.
2. Contractor to final grade around path and seed or sod according to specifications.
3. Width of path defined in Specification on as directed by the Engineer
4. All sizes and locations to be approved by the Engineer in the field.

CART PATH & CURB DETAIL
 (N.T.S.)

Proposed 6" X 8" HMA Curb
 Proposed Tack Coat
 Mill and Resurface
 HMA 9.5M64 Surface
 Course 2 1/2" thick.
 Existing Dense Graded
 Aggregate Base Course